

34562-763 EUROPACPRO DIVIDER PLATE, 6 U, 160 MM

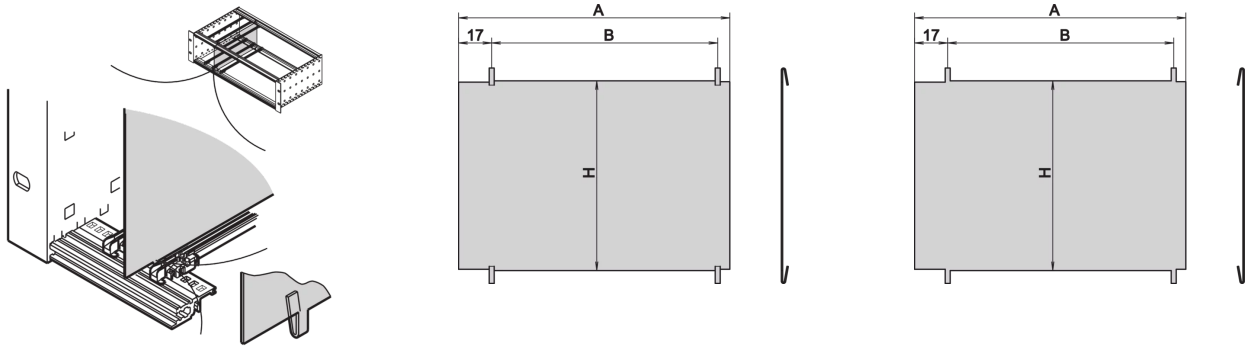

KEY FEATURES

Mounts by clipping into horizontal rails

Space requirement on component side: 2.0-mm

Fitting depends on gasketing method (stainless steel/textile gasket)

PRODUCT ATTRIBUTES

Product Type: Side Panel

Product Family: EuropacPRO

Rack Height: 6 U

Length: 160 mm

Package Quantity: 1

Depth: 160 mm

ADDITIONAL PRODUCT DETAILS

The divider plate enables the user to create a separate area inside a subrack or case. The plate can be clipped into the perforation of the horizontal rails. The subracks or cases have to be disassembled if the plate will be assembled.

Subsequent installation of the divider plate in a mounted subrack requires removal of the horizontal rails beforehand.



North America

All locations
+1.763.422.2661
Chat with us:
schroff.nvent.com

Europe

Straubenhardt, Germany
+49.7082.794.0
Betschdorf, France
+33.3.88.90.64.90
Warsaw, Poland
+48.22.209.98.35
Assago, Italy
+39.02.932.7141
Chat with us:
schroff.nvent.com

Asia

Shanghai, China
+86.21.2412.6943
Qingdao, China
+86.532.8771.6101
Singapore
+65.6768.5800
Shin-Yokohama, Japan
+81.45.476.0271
Chat with us:
schroff.nvent.com

Middle East & India

Dubai, United Arab Emirates
+971.4.378.1700
Bangalore, India
+91.80.6715.2001
Istanbul, Turkey
+90.216.250.7374
Chat with us:
schroff.nvent.com



Our powerful portfolio of brands:
nVent.com **CADDY ERICO HOFFMAN RAYCHEM SCHROFF TRACER**