

30809-673 HF FRAME TYPE PLUG-IN UNIT BODY TUBE, 14 HP, FOR 160 MM DEEP PCB

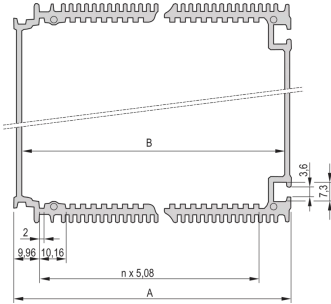
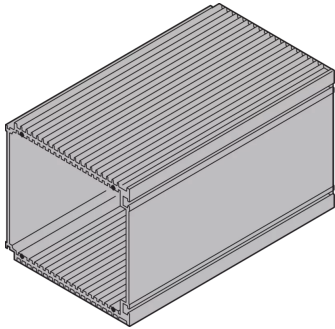

KEY FEATURES

The black HF body tube, for HF frame-type plug-in unit enables a user to insert PCBs

The tube offers a shielding against high-frequency radiation

Module body with cooling Fins

Plug-in unit can be mounted in a subrack or fitted laterally to a mounting plate with the slide nut

PRODUCT ATTRIBUTES

Product Type: Cover

Works With: Cassettes

Rack Height: 3 U

Rack Width: 14 HP

Length: 160 mm

Package Quantity: 5

ADDITIONAL PRODUCT DETAILS

The black HF body tube, for HF frame-type plug-in unit enables a user to insert PCBs.

Please order front Panel, rear Panel, brackets for PCBs and fixing materials separately.

Please take into consideration that deliveries may be carried out in the stated SPQs (SPQ, e.g. 5 pieces, 10 pieces, 50 pieces, etc.). Differing order quantities (e.g. 2 pieces) may be changed to the next possible delivery quantity = Standard Pack Quantity.



North America

All locations
+1.763.422.2661
Chat with us:
schroff.nvent.com

Europe

Straubenhardt, Germany
+49.7082.794.0
Betschdorf, France
+33.3.88.90.64.90
Warsaw, Poland
+48.22.209.98.35
Assago, Italy
+39.02.932.7141
Chat with us:
schroff.nvent.com

Asia

Shanghai, China
+86.21.2412.6943
Qingdao, China
+86.532.8771.6101
Singapore
+65.6768.5800
Shin-Yokohama, Japan
+81.45.476.0271
Chat with us:
schroff.nvent.com

Middle East & India

Dubai, United Arab Emirates
+971.4.378.1700
Bangalore, India
+91.80.6715.2001
Istanbul, Turkey
+90.216.250.7374
Chat with us:
schroff.nvent.com



Our powerful portfolio of brands:
nVent.com **CADDY ERICO HOFFMAN RAYCHEM SCHROFF TRACER**