

24571-296 RATIOACPRO 19" BRACKET KIT, RETROFITTING, 4 U

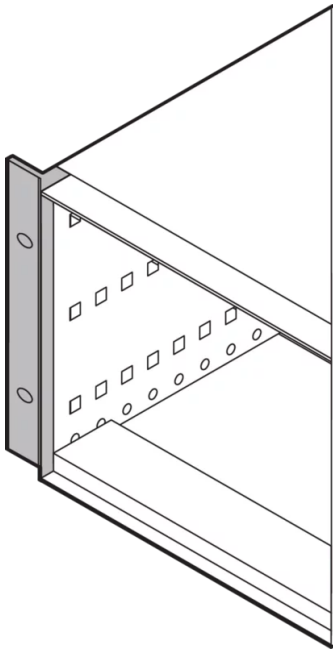

KEY FEATURES

For conversion of cases with cover strip or front handle

PRODUCT ATTRIBUTES

Product Type: Bracket

Product Family: RatiopacPRO; RatiopacPRO AIR; PropacPRO; CompacPRO

Works With: Cases

Color: Light Grey

Color Code: RAL 7016

Rack Height: 4 U

Package Quantity: 2

ADDITIONAL PRODUCT DETAILS

For conversion of Ratiopac cases with cover strip or front handle. The retrofitting of the brackets can be done without disassembly of the case.

No slide rails may be used when fitting into cabinets or 19"-cases.

CERTIFICATIONS



North America

All locations
+1.763.422.2661
Chat with us:
schroff.nvent.com

Europe

Straubenhardt, Germany
+49.7082.794.0
Betschdorf, France
+33.3.88.90.64.90
Warsaw, Poland
+48.22.209.98.35
Assago, Italy
+39.02.932.7141
Chat with us:
schroff.nvent.com

Asia

Shanghai, China
+86.21.2412.6943
Qingdao, China
+86.532.8771.6101
Singapore
+65.6768.5800
Shin-Yokohama, Japan
+81.45.476.0271
Chat with us:
schroff.nvent.com

Middle East & India

Dubai, United Arab Emirates
+971.4.378.1700
Bangalore, India
+91.80.6715.2001
Istanbul, Turkey
+90.216.250.7374
Chat with us:
schroff.nvent.com



Our powerful portfolio of brands:
nVent.com **CADDY ERICO HOFFMAN RAYCHEM SCHROFF TRACER**

© 2023 nVent. All nVent marks and logos are owned or licensed by nVent Services GmbH or its affiliates. All other trademarks are the property of their respective owners.

nVent reserves the right to change specifications without notice.