

24561-051 EUROPACPRO COVER PLATE FOR HORIZONTAL RAIL TYPE L, LIGHT, 84 HP, 175 MM

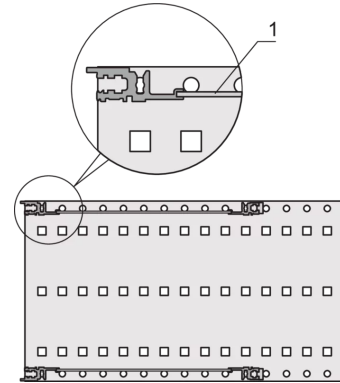
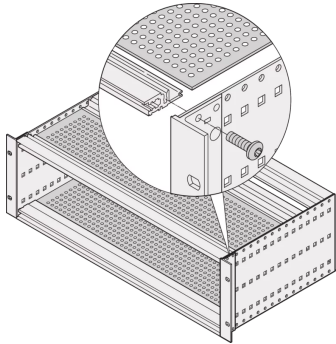

KEY FEATURES

Mechanical covering of installed components

Suitable for "light" and "flexible" subracks, for insertion into the groove of the light (type L) horizontal rails

Perforation ratio approx. 60%

PRODUCT ATTRIBUTES

Product Type: Cover Plate

Product Family: EuropacPRO

Type: Perforated

Rack Width: 84 HP

Depth: 175 mm

Package Quantity: 1

Package Unit: Pair

ADDITIONAL PRODUCT DETAILS

Mechanical covering of installed components. The plate is inserted into a groove of the L type horizontal rails.

Other dimensions on request.



North America

All locations
+1.763.422.2661
Chat with us:
schroff.nvent.com

Europe

Straubenhardt, Germany
+49.7082.794.0
Betschdorf, France
+33.3.88.90.64.90
Warsaw, Poland
+48.22.209.98.35
Assago, Italy
+39.02.932.7141
Chat with us:
schroff.nvent.com

Asia

Shanghai, China
+86.21.2412.6943
Qingdao, China
+86.532.8771.6101
Singapore
+65.6768.5800
Shin-Yokohama, Japan
+81.45.476.0271
Chat with us:
schroff.nvent.com

Middle East & India

Dubai, United Arab Emirates
+971.4.378.1700
Bangalore, India
+91.80.6715.2001
Istanbul, Turkey
+90.216.250.7374
Chat with us:
schroff.nvent.com



Our powerful portfolio of brands:
nVent.com **CADDY ERICO HOFFMAN RAYCHEM SCHROFF TRACER**