

21130-373 19" TELESCOPIC SHELF FOR VARISTAR, NOVASTAR, EURORACK, 70 KG, RAL 7021, 800W 600D

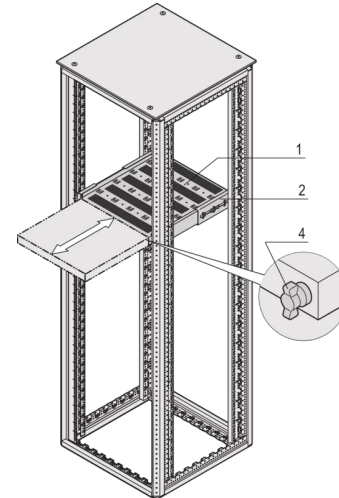
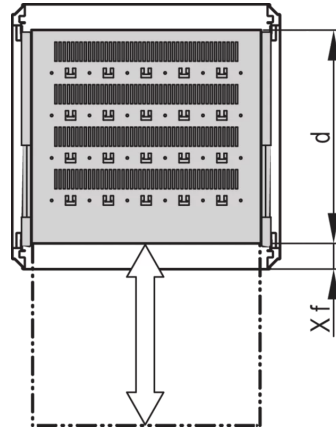

KEY FEATURES

Perforated cut-outs for assembling cable ties

Static load-carrying capacity 70 kg

Incl. telescopic slides

Locking with T-bar lock possible

St, 1.5 mm

Hammer head perforation for assembly with cable ties

PRODUCT ATTRIBUTES

Product Type: Shelf

Product Family: Varistar; Eurorack; Novastar

Type: Telescopic Shelf

Works With: Varistar CP

Color: Black Grey

Color Code: RAL 7021

Width: 400 mm

Depth: 477 mm

ADDITIONAL PRODUCT DETAILS

Varistar, Novastar and Eurorack 19" Shelf, Stationary with 70 kg load capacity, perforated for ease of assembly.

Mounting bracket for assembly of telescopic slide at frame please order separately.

Please order T-bar lock separately.

CERTIFICATIONS



North America

All locations
+1.763.422.2661
Chat with us:
schroff.nvent.com

Europe

Straubenhardt, Germany
+49.7082.794.0
Betschdorf, France
+33.3.88.90.64.90
Warsaw, Poland
+48.22.209.98.35
Assago, Italy
+39.02.932.7141
Chat with us:
schroff.nvent.com

Asia

Shanghai, China
+86.21.2412.6943
Qingdao, China
+86.532.8771.6101
Singapore
+65.6768.5800
Shin-Yokohama, Japan
+81.45.476.0271
Chat with us:
schroff.nvent.com

Middle East & India

Dubai, United Arab Emirates
+971.4.378.1700
Bangalore, India
+91.80.6715.2001
Istanbul, Turkey
+90.216.250.7374
Chat with us:
schroff.nvent.com



Our powerful portfolio of brands:
nVent.com **CADDY ERICO HOFFMAN RAYCHEM SCHROFF TRACER**

© 2023 nVent. All nVent marks and logos are owned or licensed by nVent Services GmbH or its affiliates. All other trademarks are the property of their respective owners.

nVent reserves the right to change specifications without notice.