

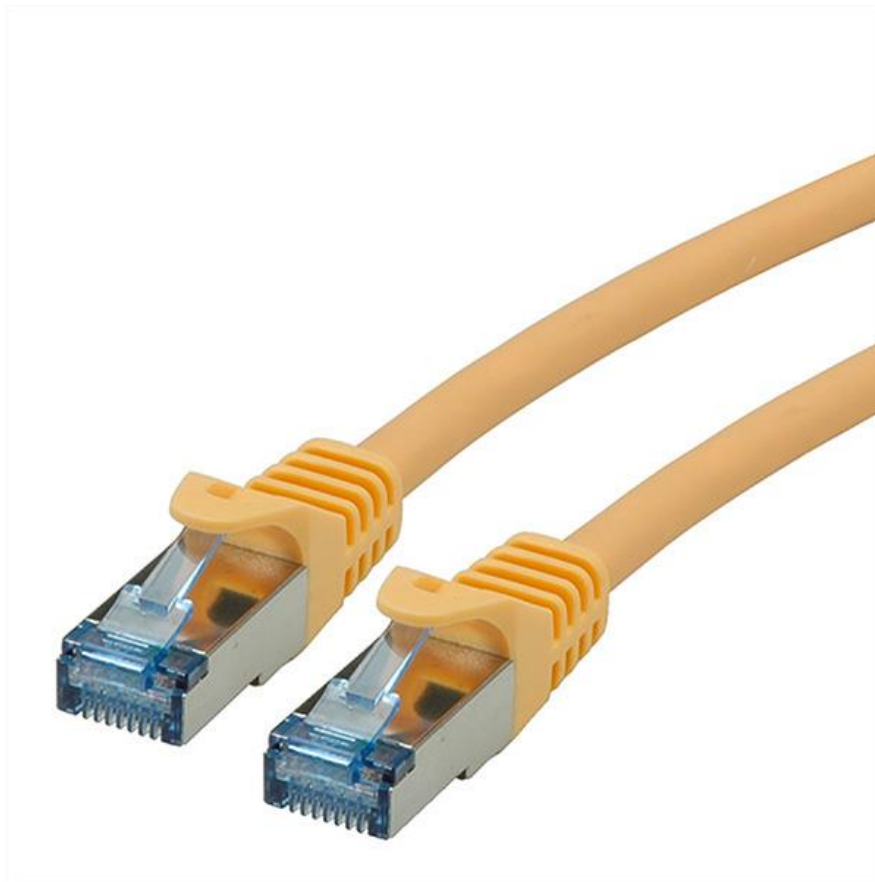

Datenblatt - Fiche technique - Data sheet

**21.15.2972**



ROLINE Patchkabel Kat.6A S/FTP (PiMF), Comp. Level, LSOH, gelb, 0,3 m

Cordon ROLINE S/FTP(PiMF) Cat.6A / 10 Gigabit, LSOH, Component Level,  
jaune, 0,3 m

ROLINE S/FTP Patch Cord Cat.6A, Component Level, LSOH, yellow, 0.3 m

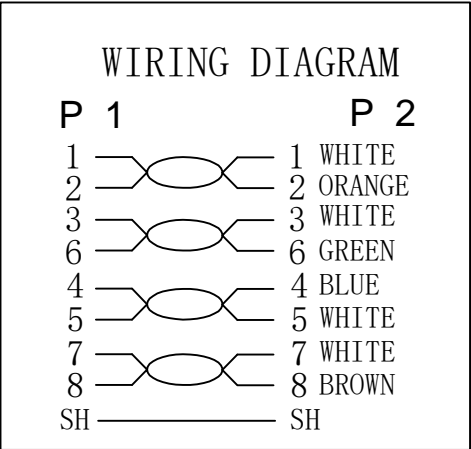
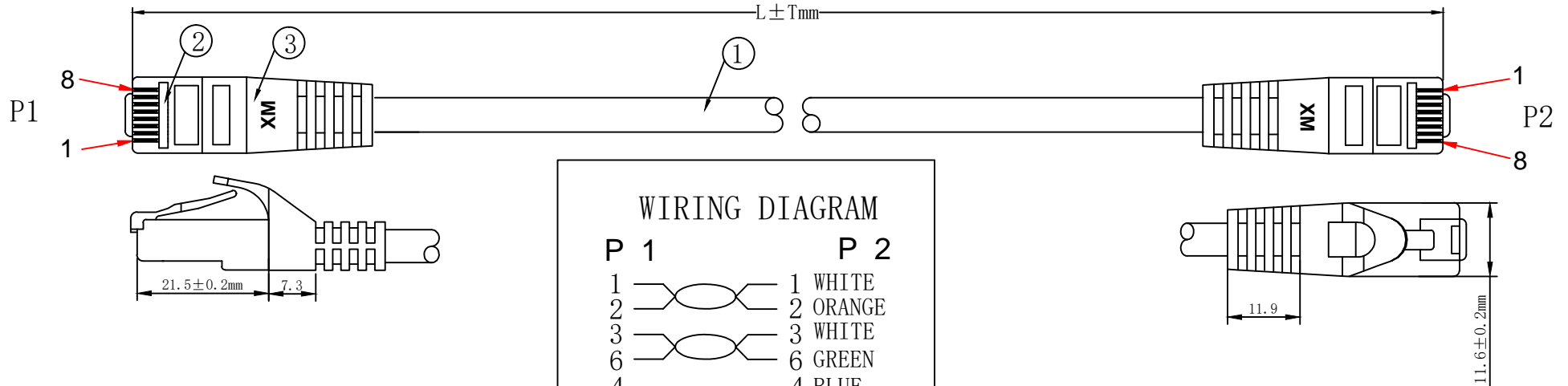

**1. ELECTRICAL TEST:**

- (1).100% OPEN SHORT & MISS WIRE TEST;
- (2).INSULATION RESISTANCE:DC 250V 20M OHM MIN;
- (3).CONTACTOR RESISTANCE:30 OHM MAX

2.PRINTING:GHMT® roline CAT.6A S/FTP COMPONENT PATCH CORD LSZH 500MHZ ISO/IEC 11801 & EN 50173-1 & ANSI/TIA-568-C.2

3.100% Component Patch cord Test PASS

4.Minimum bending radius:60mm

**MATERIAL LIST**

⑥	LABEL	NO DRY GLUE LABEL	1PCS	
⑤	MINI TIE	PE MINI TIE(POSSESS METAL)	2PCS	
④	POLYETHYLENE BAG	POLYETHYLENE BAG	1PCS	
③	OVER MOLD	88A PVC yellow	2PCS	
②	CONNECTOR	RJ45 8P8C'S SHIELDED PIN GOLD PLATED 3u", SHELL PLATED NICKEL Transparent Blue	2PCS	
①	CABLE	S/FTP CAT.6A 26AWG (BC*1P+AL-FOIL)*4P+BRAID CABLE JACKET LSOH OD=6.2±0.2MM	1PCS	
NO.	PARTS NAME	SPECIFICATION STANDARD	QT' Y	REMARK

COLOUR:yellow (PANTONE:135C)					
ITEM NO.	LENGTH (L)		TOLERANCE (T)		
21.15.2972	300mm		± 10mm		
21.15.2820	500mm		± 15mm		
21.15.2821	1000mm		± 30mm		
21.15.2824	1500mm		± 45mm		
21.15.2822	2000mm		± 60mm		
21.15.2823	3000mm		± 90mm		
21.15.2825	5000mm		± 150mm		
21.15.2826	7500mm		± 210mm		
21.15.2827	10000mm		± 300mm		
21.15.2828	15000mm		± 450mm		
21.15.2829	20000mm		± 600mm		
ITEM NO.	21.15.2972	21.15.2820	21.15.2821	21.15.2822	21.15.2823
21.15.2824	21.15.2825	21.15.2826	21.15.2827	21.15.2828	21.15.2829
DESC.	ROLINE S/FTP PatchCord CAT.6A, LSOH, Comp.Level, yellow				

**SECOMP**

BY	CHK	NEW	2016-09-13	A
		REVISION RECORD MODIFICATIONS	DATE	REV.