



Simply Better Connections

CS1953

3-Port USB-C DisplayPort Hybrid
KVMP™ Switch
User Manual

Compliance Statements

FEDERAL COMMUNICATIONS COMMISSION INTERFERENCE STATEMENT

This equipment has been tested and found to comply with the limits for a Class B digital service, pursuant to Part 15 of the FCC rules. These limits are designed to provide reasonable protection against harmful interference in a residential installation. Any changes or modifications made to this equipment may void the user's authority to operate this equipment. This equipment generates, uses, and can radiate radio frequency energy. If not installed and used in accordance with the instructions, may cause harmful interference to radio communications. However, there is no guarantee that interference will not occur in a particular installation. If this equipment does cause harmful interference to radio or television reception, which can be determined by turning the equipment off and on, the user is encouraged to try to correct the interference by one or more of the following measures:

- ◆ Reorient or relocate the receiving antenna.
- ◆ Increase the separation between the equipment and receiver.
- ◆ Connect the equipment into an outlet on a circuit different from that to which the receiver is connected.
- ◆ Consult the dealer or an experienced radio/TV technician for help.

The device complies with Part 15 of the FCC Rules. Operation is subject to the following two conditions: (1) this device may not cause harmful interference, and (2) this device must accept any interference received, including interference that may cause undesired operation.

FCC Caution: Any changes or modifications not expressly approved by the party responsible for compliance could void the user's authority to operate this equipment.



KCC Statement

유선 제품용 / B 급 기기 (가정용 방송 통신 기기)
 이 기기는 가정용 (B 급) 전자파적합기기로서 주로 가정에서 사용하는
 것을 목적으로 하며, 모든 지역에서 사용할 수 있습니다.

Industry Canada Statement

This Class B digital apparatus complies with Canadian ICES-003.

CAN ICES-003 (B) / NMB-003 (B)

RoHS

This product is RoHS compliant.

User Information

Online Registration

Be sure to register your product at our online support center:

| | |
|---------------|---|
| International | http://eservice.aten.com |
|---------------|---|

Telephone Support

For telephone support, call this number:

| | |
|---------------|---|
| International | 886-2-8692-6959 |
| China | 86-400-810-0-810 |
| Japan | 81-3-5615-5811 |
| Korea | 82-2-467-6789 |
| North America | 1-888-999-ATEN ext 4988 1-949-428-1111 |

User Notice

All information, documentation, and specifications contained in this manual are subject to change without prior notification by the manufacturer. The manufacturer makes no representations or warranties, either expressed or implied, with respect to the contents hereof and specifically disclaims any warranties as to merchantability or fitness for any particular purpose. Any of the manufacturer's software described in this manual is sold or licensed *as is*. Should the programs prove defective following their purchase, the buyer (and not the manufacturer, its distributor, or its dealer), assumes the entire cost of all necessary servicing, repair and any incidental or consequential damages resulting from any defect in the software.

The manufacturer of this system is not responsible for any radio and/or TV interference caused by unauthorized modifications to this device. It is the responsibility of the user to correct such interference.

The manufacturer is not responsible for any damage incurred in the operation of this system if the correct operational voltage setting was not selected prior to operation. PLEASE VERIFY THAT THE VOLTAGE SETTING IS CORRECT BEFORE USE.

Product Information

For information about all ATEN products and how they can help you connect without limits, visit ATEN on the Web or contact an ATEN Authorized Reseller. Visit ATEN on the Web for a list of locations and telephone numbers:

| | |
|---------------|---|
| International | http://www.aten.com |
|---------------|---|

Package Contents

Check to make sure that all the components are in working order. If you encounter any problem, please contact your dealer.

- ◆ 1 CS1953 3-Port USB-C DisplayPort Hybrid KVMPTM Switch
- ◆ 2 DisplayPort 1.2 cables
- ◆ 2 USB 3.0 Type-A to Type-B cables
- ◆ 1 USB Type-C cable
- ◆ 3 audio cables
- ◆ 1 remote port selector
- ◆ 1 power adapter (only applicable for the with-power-adapter option)
- ◆ 1 user instructions

Note: 4K video resolution needs the high quality DisplayPort Cable.

Contents

| | |
|--|-----|
| Compliance Statements | ii |
| User Information | iv |
| Online Registration | iv |
| Telephone Support | iv |
| User Notice | iv |
| Product Information | v |
| Package Contents | vi |
| Contents | vii |
| About this Manual | ix |
| Conventions | x |
| | |
| 1. Introduction | |
| Overview | 1 |
| Features | 2 |
| Requirements | 4 |
| Console | 4 |
| Computers | 4 |
| USB-C Device | 4 |
| Cables | 4 |
| Operating Systems | 5 |
| Components | 5 |
| CS1953 Front View | 5 |
| CS1953 Rear View | 6 |
| CS1953 Top View | 7 |
| Buzzer Behavior | 8 |
| | |
| 2. Hardware Setup | |
| Cable Connections | 9 |
| Installation Diagram | 12 |
| | |
| 3. Basic Operation | |
| Port Switching | 13 |
| Manual Switching | 13 |
| Mouse Switching | 14 |
| Hotkey Switching | 14 |
| Remote Port Selector Switching | 14 |
| Hot Plugging | 14 |
| Powering the Unit | 15 |
| Powering Off and Restarting | 16 |
| Port ID Numbering | 16 |
| Alternative Manual Port Selection Settings | 16 |
| | |
| 4. Hotkey Operation | |

| | |
|---|----|
| Port Switching | 17 |
| Cycling Through the Ports | 18 |
| Going Directly to a Port | 19 |
| Auto Scanning | 21 |
| Hotkey Setting Mode (HSM) | 22 |
| Invoking HSM | 22 |
| Alternate HSM Invocation Keys | 23 |
| Alternate Port Switching Keys | 23 |
| Keyboard Operating Platform | 24 |
| List Switch Settings | 24 |
| USB Reset | 24 |
| Keyboard Language | 25 |
| Buzzer Control | 25 |
| Hotkey Port Switching | 25 |
| Firmware Upgrade Mode | 25 |
| Restore Default Settings | 26 |
| Power on Detection | 26 |
| Alternative Manual Port Selection Settings | 26 |
| Keyboard Emulation Control | 26 |
| Mouse Emulation Control | 26 |
| Mouse Port Switching | 27 |
| Specific PC Port Monitor Re-detection | 27 |
| N-Key Rollover Keyboard Supporting Function | 27 |
| Switching Mode Selection | 28 |
| HSM Summary Table | 29 |

5. Keyboard Emulation

| | |
|------------------------|----|
| Mac Keyboard | 31 |
| Sun Keyboard | 32 |

6. The Firmware Upgrade Utility

| | |
|--------------------------------|----|
| Before You Begin | 33 |
| Starting the Upgrade | 35 |
| Upgrade Succeeded | 38 |
| Upgrade Failed | 38 |

7. Appendix

| | |
|---|----|
| Safety Instructions | 39 |
| Troubleshooting | 41 |
| Overview | 41 |
| Technical Support | 42 |
| International | 42 |
| North America | 42 |
| Specifications | 43 |
| Hotkey Default Settings | 44 |
| ATEN Standard Warranty Policy | 45 |

About this Manual

This User Manual is provided to help you get the most from your CS1953 unit. It covers all aspects of installation, configuration and operation. An overview of the information found in the manual is provided below.

Chapter 1, Introduction, introduces you to the CS1953. Its purpose, features and benefits are presented, and its front, side, and back panel components are described.

Chapter 2, Hardware Setup, describes how to set up your installation. The necessary steps are provided.

Chapter 3, Basic Operation, explains the fundamental concepts involved in operating the CS1953.

Chapter 4, Hotkey Operation, details all of the concepts and procedures involved in the Hotkey operation of your CS1953 installation.

Chapter 5, Keyboard Emulation, provides tables that list the PC to Mac and PC to Sun keyboard emulation mappings.

Chapter 6, The Firmware Upgrade Utility, explains how to use the CS1953's firmware with the latest available versions.

Appendix, which provides specifications and other technical information regarding the CS1953.

Note:

- ◆ Read this manual thoroughly and follow the installation and operation procedures carefully to prevent any damage to the unit or any connected devices.
 - ◆ The product may be updated with features and functions added, improved or removed since the release of this manual. For an up-to-date user manual, visit <http://www.aten.com/global/en/>
-

Conventions

This manual uses the following conventions:

- | | |
|---|--|
| Monospaced | Indicates text that you should key in. |
| [] | Indicates keys you should press. For example, [Enter] means to press the Enter key. If keys need to be chorded, they appear together in the same bracket with a plus sign between them: [Ctrl+Alt]. |
| 1. | Numbered lists represent procedures with sequential steps. |
| ◆ | Bullet lists provide information, but do not involve sequential steps. |
| > | Indicates selecting the option (on a menu or dialog box, for example), that comes next. For example, Start > Run means to open the <i>Start</i> menu, and then select <i>Run</i> . |
|  | Indicates critical information. |

Chapter 1

Introduction

Overview

The CS1953 3-Port USB-C DisplayPort Hybrid KVMPTM Switch combines KVM switch with DisplayPort video interface, one USB-C device and 2-port USB 3.1 Gen 1 hub. The DisplayPort interface provides 4K DCI @ 60 Hz resolution that displays the most vivid high-definition images available while producing premium sounds. In addition, the CS1953 provides USB-C device power delivery 3.0 standard for power supply to the USB-C device.

The CS1953 allows users to access two DisplayPort computers and one USB-C device from a single USB keyboard and USB mouse. In addition to the front panel pushbuttons, remote port selector, and mouse port-switching functionality, the CS1953 offers hotkeys to help switch ports and configure device settings. A Power On Detection feature also ensures that if one computer is powered off, the CS1953 will automatically switch ports to the next powered-on computer.

With a built-in USB 3.1 Gen 1 hub, the CS1953 provides SuperSpeed 5 Gbps transfer rates to all connected USB peripherals. The unit's independent (asynchronous) switching feature, allows the KVM focus to be on one computer while the USB peripheral focus is on another computer. This eliminates the need to purchase a separate USB hub or stand-alone peripheral sharer – such as a print server, modem splitter, etc.

Featuring an unbeatable combination of ultra high 4K resolutions, a next generation USB 3.1 Gen 1 hub and enhanced, user-friendly operations, the CS1953 delivers the latest innovations in desktop KVM switching technology.

Features

- ◆ One USB keyboard, mouse and one DisplayPort monitor control two DisplayPort computers, one USB-C device and share two USB peripherals
- ◆ Provides USB Power Delivery 3.0 for USB-C device charging up to 45W¹
- ◆ Supports superior video quality – up to 4K DCI (4096 x 2160 @ 60Hz)
- ◆ Computer selection via pushbuttons, hotkeys, mouse², and remote port selector
- ◆ Built-in 2-port USB 3.1 Gen 1 hub with SuperSpeed 5 Gbps data transfer rates
- ◆ Supports DisplayPort Alternate Mode (DP Alt Mode) which enables the USB connection to carry DisplayPort signals
- ◆ Supports Console keyboard emulation/bypass feature
- ◆ Supports Console mouse emulation/bypass feature
- ◆ Independent switching of KVM, USB peripheral, and audio focus³
- ◆ Multilingual keyboard mapping - supports English, Japanese, French, and German keyboards
- ◆ Supports HD Audio³
- ◆ DisplayPort 1.2⁴ compliant; HDCP 1.4 compliant
- ◆ Power on detection – if a computer is powered off, the CS1953 automatically switches to the next powered-on computer
- ◆ DisplayPort Dual-Mode technology (DP++) supports HDMI and DVI signals via a DisplayPort-to-HDMI/DVI DP++ adapter⁵
- ◆ Hot pluggable – add or remove computers without powering down the switch
- ◆ Sun and Mac keyboard support and emulation⁶
- ◆ Auto Scan Mode for monitoring all computers
- ◆ Firmware upgradeable
- ◆ Supports N-key Rollover⁷ (NKRO) – permits collision-free keying
- ◆ Bus-powered⁸

Note: 1. An additional power adapter is needed on the CS1953 for USB-C device charging to work.

2. Mouse port switching is only supported under mouse emulation mode with a USB 3-button mouse wheel.
 3. HD audio through DisplayPort channel cannot be switched independently.
 4. For DisplayPort compliant display device, make sure to configure the device setting to be compatible with DisplayPort 1.2 to avoid compatibility issue.
 5. DisplayPort Dual-Mode technology (DP++) does not require an active adapter for most single display setups. Active DisplayPort adapters are recommended if you are unsure of the video source's DP++ compatibility.
 6. PC keyboard combinations emulate Mac keyboards. Mac keyboards only work with their own operating system.
 7. N-key Rollover supports up to 15 simultaneous keystrokes.
 8. The unit can be bus-powered by the connected KVM sources via USB ports. See *Powering the Unit*, page 15.
-

Requirements

Console

- ◆ One DisplayPort monitor capable of the highest possible resolution
- ◆ A USB mouse
- ◆ A USB keyboard
- ◆ Speakers

Computers

The following equipment must be available on each computer:

- ◆ One DisplayPort port
- ◆ A USB Type-A port
- ◆ An audio port

USB-C Device

The following equipment must be available on the USB-C device:

- ◆ A USB-C port
- ◆ An audio port

Note: For video output to work through a USB-C port, the device must support DP Alt Mode.

Cables

To guarantee video quality, we recommend using only ATEN DisplayPort KVM cables which are certified by the VESA Compliance Program.

Note:

- ◆ The quality of the display is affected by the quality of the cables. We recommend the total length from the source to the monitor to not exceed 3 meters (1.5 meters between the PC and the KVM switch. 1.5 meters between the KVM switch and the monitor). If you need additional cables, please contact your dealer to purchase ATEN approved cables.
 - ◆ If you are using DisplayPort cables that are only DP 1.1 compliant, make sure the DisplayPort setting of the monitor is set to auto or DP 1.1.
-

Operating Systems

- ◆ Windows
- ◆ Mac
- ◆ Linux

Components

CS1953 Front View



| No. | Component | Description |
|-----|-------------------------------|--|
| 1 | remote port selector jack | The remote port selector plugs in here. |
| 2 | audio jack | Your main console speakers plug in here Note: The speakers plugged into this jack have priority over those plugged into the rear panel. |
| 3 | USB 3.1 Gen 1 peripheral port | USB peripherals (printers, scanners, drives etc.) plug into this port. This USB 3.1 Gen 1 port features 5 Gbps data transfer rates for compatible USB peripherals. |

CS1953 Rear View

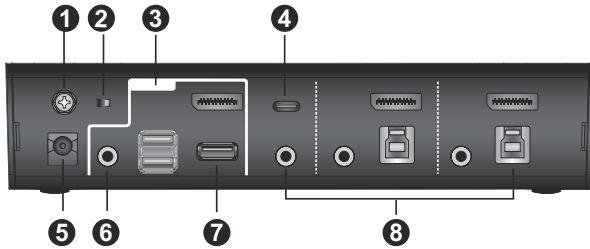

| No. | Component | Description |
|-----|-------------------------------|--|
| 1 | grounding terminal | The grounding wire used to ground the switch attaches here. |
| 2 | 4K resolution switch | Switches between 4K60 and 4K30 resolution for USB-C device connected to CPU 3. <ul style="list-style-type: none"> ◆ 4K60: The CPU 3 provides 4K @ 60Hz resolution and USB 2.0 data transfer rate. ◆ 4K30: The CPU 3 provides 4K @ 30Hz resolution and USB 3.1 Gen1 data transfer rate. |
| 3 | console ports section | The cables from your keyboard, mouse, monitors, and speakers plug in here. Each connector is marked with an appropriate icon to indicate itself. |
| 4 | USB-C port | The cables that link the switch to your USB-C device plug in here. This KVM port section is comprised of a speaker jack, and USB-C connector. |
| 5 | power jack | The power adapter cable plugs into this jack. |
| 6 | audio jack | Your console speakers plug in here. Note: The speakers plugged into the front panel have priority over those plugged into this jack. |
| 7 | USB 3.1 Gen 1 peripheral port | USB peripherals (printers, scanners, drives etc.) plug into this port. This USB 3.1 Gen 1 port features 5 Gbps data transfer rates for compatible USB peripherals. |
| 8 | KVM ports sections | The cables that link the switch to your computers plug in here. Each KVM port section is comprised of a speaker jack, USB Type-B port and one DisplayPort connector. |

CS1953 Top View

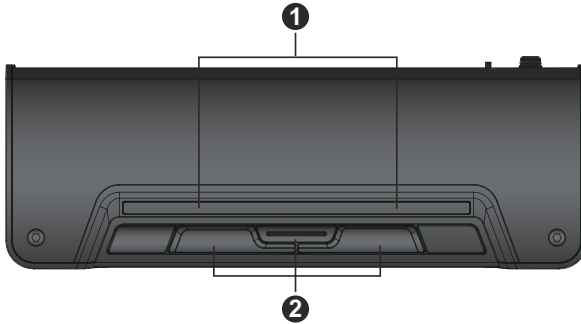

| No. | Component | Description |
|-----|----------------------------|---|
| 1 | LED status panel | <p>The LEDs will light to indicate its mode and status:</p> <div data-bbox="585 627 806 699" style="text-align: center;"> <p>Audio KVM USB</p> </div> <p>KVM</p> <ul style="list-style-type: none"> ◆ Lights DIM ORANGE to indicate that the computer attached to the corresponding port is connected (online). ◆ Changes to BRIGHT ORANGE to indicate that the computer attached to its corresponding port is the one that has the KVM focus (Selected). ◆ Flashes to indicate that the computer attached to its corresponding port is being accessed under Auto Scan mode. ◆ All LEDs flash together to indicate Firmware Upgrade Mode is in effect. <p>USB</p> <ul style="list-style-type: none"> ◆ Lights GREEN to indicate that the computer attached to its corresponding port is the one that has access to the USB peripherals. <p>Audio</p> <ul style="list-style-type: none"> ◆ Lights GREEN to indicate that the audio is being outputted from the corresponding port(s). |
| 2 | port selection pushbuttons | <p>For manual port selection (see <i>Manual Switching</i>, page 13):</p> <ul style="list-style-type: none"> ◆ Press a switch for less than two seconds to bring the KVM, USB hub, and audio focus to the computer attached to its corresponding port. ◆ Press a port selection pushbutton for longer than two seconds to only bring the KVM focus to the computer attached to its corresponding port. ◆ Press a port selection pushbutton twice to bring the audio focus to the computer attached to its corresponding port. ◆ Press port selection pushbuttons 1 and 3 simultaneously for 2 seconds to start Auto Scan Mode (see <i>Auto Scanning</i>, page 21). ◆ Press port selection pushbuttons 2 and 3 simultaneously for 2 seconds to perform a Keyboard/Mouse reset. (see <i>USB Reset</i>, page 24). |

Buzzer Behavior

| Sound | Description |
|-------------|---|
| 1 beep | <ul style="list-style-type: none">◆ Changing port◆ Activating auto-scan mode◆ Pausing/resuming auto-scan |
| 1 long beep | <ul style="list-style-type: none">◆ Powering on the unit◆ Resetting the unit |
| 2 beeps | <ul style="list-style-type: none">◆ Interrupting auto-scan◆ Entering keyboard emulation off mode◆ Finishing USB synchronization |

Refer to *Buzzer Control* on page 25 if you wish to turn the buzzer on or off.

Chapter 2

Hardware Setup



1. Important safety information regarding the placement of this device is provided on page 39. Please review it before proceeding.
2. To prevent damage to your installation from power surges or static electricity. It is important that all connected devices are properly grounded.
3. Make sure that power to all the devices you will be installing has been turned off. You must unplug the power cords of any computers that have the Keyboard Power On function.
4. Please operate the device with caution when under high environmental temperatures, as the surface of the device may become overheated under such conditions. For instance, the surface temperature of the device may reach 70 °C (158 °F) or higher when the environmental temperature reaches close 50 °C (122 °F).

Cable Connections

To set up your installation, refer to the installation diagram on the following page (the numbers in the diagram on page 11 correspond to the steps below), and do the following:

1. Ground the CS1953 by connecting one end of a grounding wire to the grounding terminal and the other end to a suitable grounded object.

Note: Do not omit this step. Proper grounding helps to prevent damage to the unit from power surges or static electricity.

2. Plug your USB keyboard and USB mouse into the USB console ports from the console ports section located on the unit's rear panel.
3. Plug your monitor into the DisplayPort console port from the console ports section located on the unit's rear panel and power on the monitor.

4. Plug your speakers into the audio jacks located on the unit's front and rear panel. The speakers plugged into the front panel have priority over those plugged into the rear panel.
5. Using the DisplayPort cable, plug the DisplayPort connector into any available DisplayPort port on the KVM ports section of the switch (CPU 1 and CPU 2), then plug the USB 3.0 cable and audio cable into their corresponding ports.

Note:

- ◆ Verify that all the connectors are in the same KVM ports section (all in CPU 1, all in CPU 2).
 - ◆ The unit can be bus-powered by the connected KVM sources via USB ports. See *Powering the Unit*, page 15.
-

6. At the other end of the cables from step 5, plug the DisplayPort cable, USB 3.0 cable, and audio cable into their respective ports on the computer. Repeat steps 5, and 6 for other PC systems you are installing.
7. Using the USB-C cable, plug the USB-C connector into the USB-C port on the KVM ports section of the switch (CPU 3), then plug the audio cable into its corresponding port.
8. At the other end of the cables from step 7, plug the USB-C cable and audio cable into their respective ports on the USB-C device.

Note: For video output to work through a USB-C port, the device must support DP Alt Mode.

9. Switch the 4K Resolution Switch to set a 4K resolution between 4K60 and 4K30 for USB-C device connected to CPU 3.
 - a) When the switch is set to 4K60, the CPU 3 provides 4K @ 60Hz resolution and USB 2.0 data transfer rates.
 - b) When the switch is set to 4K30, the CPU 3 provides 4K @ 30Hz resolution and USB 3.1 Gen1 data transfer rates.
10. (Optional) Plug your USB peripherals into the front or rear USB 3.1 Gen 1 peripheral ports.
11. (Optional) If you choose to use the remote port selector, plug its cable into the remote port selector jack, located on the unit's front panel.

12. (Optional) Plug a power adapter into an AC power source, then plug the power adapter cable into the switch's power jack.

Note:

- ◆ The unit can be bus-powered by the connected KVM sources via USB ports. See *Powering the Unit*, page 15.
 - ◆ To purchase a power adapter for the CS1953, contact your ATEN dealer for more information.
-

13. Power on the computers and USB-C device.

Note:

- ◆ By default, the switch links to the first computer that is powered on.
 - ◆ The total cable length from the PC to monitor (including KVM) cannot exceed 3 meters.
 - ◆ Choosing high quality cables helps to ensure that 4K UHD (3840 x 2160 @ 60 Hz) or 4K DCI (4096 x 2160 @ 60 Hz) resolutions can be reached.
 - ◆ It is highly recommended that the CS1953 is kept powered on at all times.
 - ◆ Make sure the computers and devices that the CS1953 connects to are also properly grounded.
-

Installation Diagram

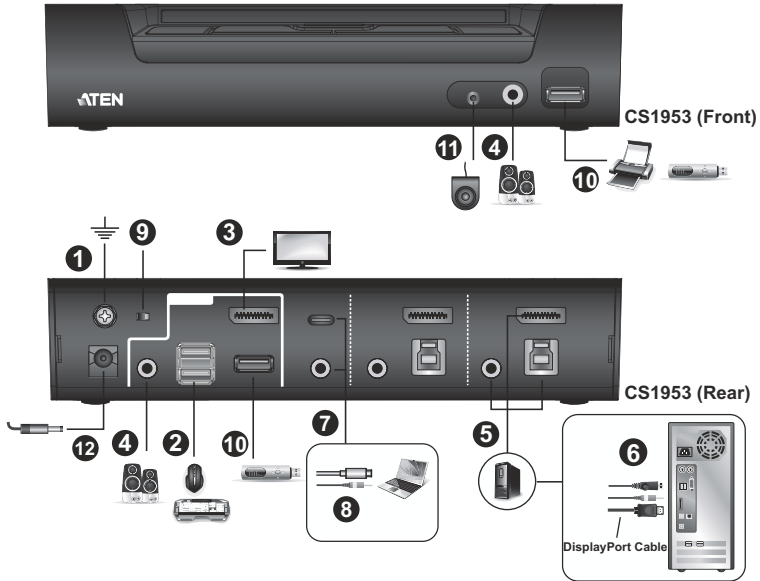

Chapter 3

Basic Operation

Port Switching

There are four convenient methods to switch between the computers: Manual – by pressing the port selection pushbuttons on the front panel, Mouse – by clicking the scroll wheel of the mouse, Hotkey – by entering combinations on the keyboard, and Remote Port Selector – by pressing the remote port selector button.

Manual Switching

For manual port selection:

- ◆ Press and release a port selection pushbutton to bring the KVM focus, plus the USB and Audio focus, to the computer attached to its corresponding port.
- ◆ Press and hold a port selection pushbutton for more than 2 seconds to bring the KVM focus to the computer attached to its corresponding port. The USB and Audio focus does not change – they stay with the port that they are already on.
- ◆ Press a port selection pushbutton twice to bring the audio focus to the computer attached to its corresponding port.
- ◆ Press and hold port selection pushbuttons 1 and 3 for more than 2 seconds to start Auto Scan Mode (see page 21 for details).
- ◆ Press and release either port selection pushbutton to stop Auto Scan Mode. The KVM focus goes to the computer attached to the corresponding port of the switch you pressed.
- ◆ Press and hold port selection pushbuttons 2 and 3 for more than 2 seconds to perform a Keyboard/Mouse reset (see page 24 for details).

Mouse Switching

For mouse port selection: Double-click the scroll wheel of your USB mouse to cycle through the ports.

Note:

- ◆ Mouse switching is only supported by USB 3-key scroll wheel mice.
 - ◆ Mouse switching is disabled by default. See *Hotkey Setting Mode (HSM)*, page 22, to enable mouse switching.
 - ◆ Mouse switching is only supported when Mouse Emulation is enabled.
-

Hotkey Switching

For Hotkey port selection: All port switches from the keyboard begin by pressing the Scroll Lock key twice. Regarding details of the Hotkey parameters, see *Hotkey Operation*, page 17.

Remote Port Selector Switching

For Remote Port Selection: Press the remote port selector button to cycle through the ports. Make sure the remote port selector is plugged into the Remote Port Selector Jack.

Hot Plugging

The CS1953 supports USB hot plugging – components can be removed and added back into the installation by unplugging their cables from the USB hub ports without the need to shut the unit down.

Powering the Unit

It is strongly recommended that you fully power the CS1953. To do so, connect all three KVM USB ports to powered sources or connect the optional power adapter. A fully powered unit allows you to have the keyboard, mouse and USB peripherals fully operational.

If you want to power your USB-C compliant device through the CS1953 (power delivery function), connect the optional power adapter. A summary table is shown below:

| Power Source(s) | Powered Device and Function |
|---|---|
| 2 x PC ¹ | Keyboard, Video, and Mouse |
| 1 x USB-C Device ² | Keyboard, Video, Mouse, and USB Peripherals. |
| 2 x PC 1 x USB-C Device ² | |
| Power Adapter ³ | Keyboard, Video, Mouse, USB Peripherals, and USB-C device charging. |

- Note:**
1. Connecting at least two USB-B ports to KVM sources (e.g. PC) may allow normal operation of the keyboard, mouse, and monitor.
 2. The USB-C device must itself be powered (e.g. laptop connected by its own power adapter).
 3. To purchase a power adapter for the CS1953, contact your ATEN dealer for more information. Alternatively, supply a power adapter with the following specifications: 12V/7.5A, less than 112W, and with a DC jack 5.5mm outer diameter and 2.5mm inner diameter.

Powering Off and Restarting

If it becomes necessary to power off the CS1953 unit, before starting it back up, you must do the following:

1. Shut down all the computers that are attached to the switch.
2. Unplug the switch's power adapter cable.
3. Wait 10 seconds, then plug the switch's power adapter cable back in.
4. Once the switch is powered up, power on the computers.

Port ID Numbering

Each KVM port section on the CS1953 switch is assigned a port number (1 to 4). The port numbers are marked (CPU 1, CPU 2, and CPU 3) on the rear panel of the switch (see page 6 for details).

The Port ID of a computer is derived from the KVM port number it is connected to. For example, a computer connected to KVM port 2 has a Port ID of 2.

The Port ID is used to specify which computer gets the KVM, USB peripheral, and audio focus with the Hotkey port selection method (see page 19 for details).

Alternative Manual Port Selection Settings

When Hotkey Setting Mode has been activated, pressing [S] will invoke the alternative front panel pushbutton manual port selection functions, as explained below:

- ◆ Press a port selection pushbutton once to bring only the KVM focus to the computer attached to its corresponding port.
- ◆ Press and hold a port selection pushbutton for more than 2 seconds to bring the KVM, audio and USB focus to the computer attached to its corresponding port.
- ◆ Press a port selection pushbutton twice to bring the audio focus to the computer attached to its corresponding port.
- ◆ Press and hold port selection pushbuttons 1 and 3 for more than 2 seconds to start Auto Scan Mode, see page 21 for details.

Chapter 4

Hotkey Operation

The CS1953 provides an extensive, easy-to-use, Hotkey function that makes it convenient to control and configure your KVM installation from the keyboard. Hotkeys provide asynchronous (independent) switching of the KVM, USB hub and audio focus. If you wish, you can give one computer the KVM console focus, another the USB hub focus and the other two the audio focus.

Port Switching

All port switches begin with tapping the **[Scroll Lock]** key twice. The tables below describe the actions that each combination performs.

Note: If using the Scroll Lock key conflicts with other programs running on the computer, the **[Ctrl]** key can be used, instead. See *Alternate Port Switching Keys*, page 23, for details.

Cycling Through the Ports

| Hotkey | Action |
|--|--|
| [Scroll Lock] [Scroll Lock] [Enter] | <p>Brings the KVM, USB hub, and audio focus from the port that currently has the KVM focus to the next port on the installation (1 to 2; 2 to 3; 3 to 4; 4 to 1).</p> <p>Example:</p> <ol style="list-style-type: none"> 1. Press [Scroll Lock] twice. 2. Press [Enter]. |
| [Scroll Lock] [Scroll Lock] [K] [Enter] | <p>Brings only the KVM focus from the port that currently has it to the next port on the installation. The USB and audio focus remain where they are.</p> <p>Example:</p> <ol style="list-style-type: none"> 1. Press [Scroll Lock] twice. 2. Press [K]. 3. Press [Enter]. |
| [Scroll Lock] [Scroll Lock] [U] [Enter] | <p>Brings only the USB hub focus from the port that currently has it to the next port on the installation. The KVM and audio focus remain where they are.</p> <p>Example:</p> <ol style="list-style-type: none"> 1. Press [Scroll Lock] twice. 2. Press [U]. 3. Press [Enter]. |
| [Scroll Lock] [Scroll Lock] [S] [Enter] | <p>Brings only the audio focus from the port that currently has it to the next port on the installation. The KVM and USB hub focus remain where they are.</p> <p>Example:</p> <ol style="list-style-type: none"> 1. Press [Scroll Lock] twice. 2. Press [S]. 3. Press [Enter]. |

Going Directly to a Port

| Hotkey | Action |
|--|---|
| [Scroll Lock] [Scroll Lock] [n] [Enter] | Brings the KVM , USB hub , and audio focus to the computer attached to the port corresponding to the specified Port ID. Example: <ol style="list-style-type: none"> 1. Press [Scroll Lock] twice. 2. Press [2]. 3. Press [Enter]. |
| [Scroll Lock] [Scroll Lock] [n] [K] [Enter] | Brings only the KVM focus to the computer attached to the specified port. The USB hub and audio focus remain where they are. Example: <ol style="list-style-type: none"> 1. Press [Scroll Lock] twice. 2. Press [2]. 3. Press [K]. 4. Press [Enter]. |
| [Scroll Lock] [Scroll Lock] [n] [U] [Enter] | Brings only the USB hub focus to the computer attached to the specified port. The KVM and audio focus remain where they are. Example: <ol style="list-style-type: none"> 1. Press [Scroll Lock] twice. 2. Press [2]. 3. Press [U]. 4. Press [Enter]. |
| [Scroll Lock] [Scroll Lock] [n] [S] [Enter] | Brings only the audio focus to the computer attached to the specified port. The KVM and USB hub focus remain where they are. Example: <ol style="list-style-type: none"> 1. Press [Scroll Lock] twice. 2. Press [2]. 3. Press [S]. 4. Press [Enter]. |

| Hotkey | Action |
|--|--|
| [Scroll Lock] [Scroll Lock] [n] [K] [U] [Enter] | <p>Brings the KVM and USB hub focus to the computer attached to the specified port. The audio focus remains where it is.</p> <p>Example:</p> <ol style="list-style-type: none"> 1. Press [Scroll Lock] twice. 2. Press [2]. 3. Press [K], and then press [U]. 4. Press [Enter]. |
| [Scroll Lock] [Scroll Lock] [n] [K] [S] [Enter] | <p>Brings the KVM and audio focus to the computer attached to the specified port. The USB hub focus remains where it is.</p> <p>Example:</p> <ol style="list-style-type: none"> 1. Press [Scroll Lock] twice. 2. Press [2]. 3. Press [K], and then press [S]. 4. Press [Enter]. |
| [Scroll Lock] [Scroll Lock] [n] [U] [S] [Enter] | <p>Brings the USB hub and audio focus to the computer attached to the specified port. The KVM focus remains where it is.</p> <p>Example:</p> <ol style="list-style-type: none"> 1. Press [Scroll Lock] twice. 2. Press [2]. 3. Press [U], and then press [S]. 4. Press [Enter]. |
| [Scroll Lock] [Scroll Lock] [n] [K] [S] [U] [Enter] | <p>Brings the KVM, USB hub and audio focus to the computer attached to the specified port.</p> <p>Example:</p> <ol style="list-style-type: none"> 1. Press [Scroll Lock] twice. 2. Press [2]. 3. Press [K], [S], and then press [U]. 4. Press [Enter]. <p>Note: This is the same action as [Scroll Lock] [Scroll Lock] [n] [Enter].</p> |

Note: The **n** stands for the computer's Port ID number (1, 2, or 3). See *Port ID Numbering*, page 16 for details. Replace the **n** with the appropriate Port ID when entering Hotkey combinations.

Auto Scanning

The CS1953's Auto Scan feature automatically cycles the KVM focus through the computer ports at regular intervals. This allows you to monitor the computer activity without having to take the trouble of switching from port to port manually. See the table below for details.

| Hotkey | Action |
|---|--|
| [Scroll Lock] [Scroll Lock] [A] [Enter] | Invokes Auto Scan. The KVM focus cycles from port to port at 5 second intervals . Five second intervals is the Default setting. |
| [Scroll Lock] [Scroll Lock] [A] [n] [Enter] | The KVM focus cycles from port to port at n second intervals. |

Note:

- ◆ The **n** stands for the number of seconds that the CS1953 should dwell on a port before moving on to the next. Replace the **n** with a number between 1 and 99 when entering this Hotkey combination.
- ◆ While Auto Scan Mode is in effect, ordinary keyboard and mouse functions are suspended – only Auto Scan Mode compliant keystrokes and mouse clicks can be input. You must exit Auto Scan Mode in order to regain normal control of the console.
- ◆ Although the video focus switches from port to port, the audio and USB focus do not switch. They stay at the port they were on when Auto Scanning started
- ◆ To exit Auto Scan Mode, press the **[Esc]** key, or the **[Spacebar]**.

Hotkey Setting Mode (HSM)

Hotkey Setting Mode (HSM) is used to set up your CS1953 switch configuration. All operations begin with invoking Hotkey Setting Mode.

Invoking HSM

To invoke HSM do the following:

1. Press and hold down [**Num Lock**].
2. Press and release [-].
3. Release [**Num Lock**].

Note: There is an alternate key combination to invoke HSM. See below for details.

When HSM is active, the Caps Lock, and Scroll Lock LEDs flash in succession to indicate that HSM is in effect. They stop flashing and revert to normal status when you exit HSM.

Ordinary keyboard and mouse functions are suspended – only Hotkey compliant keystrokes and mouse clicks (described in the sections that follow), can be input.

At the conclusion of some Hotkey operations, you automatically exit Hotkey mode. With some operations, you must exit manually. To exit HSM manually, press the [**Esc**] key, or the [**Spacebar**].

Alternate HSM Invocation Keys

An alternate set of HSM invocation keys is provided in case the default set conflicts with programs running on the computers.

To switch to the alternate HSM invocation set, do the following:

1. Invoke HSM (see page 22).
2. Press and release [**H**].

The HSM invocation keys become the [**Ctrl**] key (instead of [**Num Lock**]) and the [**F12**] key (instead of [-]).

Note: This procedure is a toggle between the two methods. To revert back to the original HSM invocation keys, invoke HSM, then press and release the [**H**] key again.

Alternate Port Switching Keys

An alternate way of activating port switching is by pressing the [**Ctrl**] key twice. To use the alternate port switching hotkeys, do the following:

1. Invoke HSM (see page 22).
2. Press and release [**T**].

Note: This procedure is a toggle between the two methods. To revert back to the original [**Scroll Lock**] [**Scroll Lock**] method, go through the steps above.

Keyboard Operating Platform

The CS1953's default port configuration is for a PC compatible keyboard operating platform. If your console uses a PC compatible keyboard and you have a Mac or Sun attached to a port, for example, you can change the port's keyboard operating platform configuration so that the PC compatible keyboard emulates the Mac or Sun keyboard. The procedure is as follows:

1. Bring the KVM focus to the port you want to set.
2. Invoke HSM (see page 22).
3. Press and release the appropriate Function key (see table below). After completing this procedure, you automatically exit HSM.

| Function Key | Operation |
|---------------------|---|
| [F1] | Sets the SPC mode so that it can work under special operating systems as a standard (104 key) keyboard. |
| [F2] | Enables Mac keyboard emulation, see page 31, for details. |
| [F3] | Enables Sun keyboard emulation, see page 32, for details. |
| [F10] | Enables Windows keyboard emulation. |

List Switch Settings

To see a listing of the current switch settings, do the following:

1. Open a text editor or word processor and place the cursor in the page window.
2. Invoke HSM (see page 22).
3. Press and release **[F4]** to display the settings.

USB Reset

If the USB loses focus and needs to be reset, do the following:

1. Invoke HSM (see page 22).
2. Press and release **[F5]**.

Keyboard Language

To change the keyboard language, do the following:

1. Invoke HSM (see page 22).
2. Press and release **[F6] [nn] [Enter]**.

Note: **nn** is a two-digit number that represents the keyboard language code (US English: 33; French: 08; Japanese: 15; German: 09).

Buzzer Control

The buzzer can be turned on or off. To turn the buzzer on/off, do the following:

1. Invoke HSM (see page 22).
2. Press and release **[B]**.

Hotkey Port Switching

To enable/disable hotkey port switching, do the following:

1. Invoke HSM (see page 22).
2. Press **[X] [Enter]**.

When disabled, port switching hotkeys **[Scroll Lock] [Scroll Lock]** (and the alternative **[Ctrl] [Ctrl]**) will not work.

Firmware Upgrade Mode

To enter Firmware Upgrade Mode, do the following:

1. Invoke HSM (see page 22).
2. Key in: upgrade
3. Press **[Enter]**.

The front panel LEDs flash to indicate Firmware Upgrade Mode is in effect.

Note: To exit Firmware Upgrade Mode, you must power off the switch.

Restore Default Settings

To reset the CS1953 to its default Hotkey settings, do the following:

1. Invoke HSM (see page 22).
2. Press **[R]** **[Enter]**.

All Hotkey settings return to the factory default settings.

Power on Detection

With Power on Detection, if the focus computer is powered off, the switch will automatically switch to the next powered-on computer. Power on Detection can be enabled or disabled. The default setting is enabled. To enable/disable Power on Detection, do the following:

1. Invoke HSM (see page 22).
2. Press **[E]**.

Alternative Manual Port Selection Settings

To toggle between the default and the alternative front panel pushbutton manual port selection settings, do the following:

1. Invoke HSM (see page 22).
2. Press **[S]**.

See *Alternative Manual Port Selection Settings*, page 16, for full details of the alternative front panel pushbutton manual port selection settings.

Keyboard Emulation Control

To enable/disable keyboard emulation, do the following:

1. Invoke HSM (see page 22).
2. Press **[N]**.

Mouse Emulation Control

To enable/disable mouse emulation, do the following:

1. Invoke HSM (see page 22).
2. Press **[M]**.

Mouse Port Switching

Mouse Port Switching allows you to switch ports using mouse wheel button (clicked twice). For Mouse Port Switching to work, Mouse Emulation must be enabled. To enable/disable mouse port switching, do the following:

1. Invoke HSM (see page 22).
2. Press **[W]**.

Specific PC Port Monitor Re-detection

If the monitor's display is blank, use this hotkey to re-detect the monitor's EDID. Specific PC port monitor re-detection can be enabled or disabled. The default setting is disabled. To enable specific PC port monitor re-detection, do the following:

1. Invoke HSM (see page 22).
2. Press **[Q] [n] [Enter]**.

Note: The **n** stands for the computer's Port ID number (1, 2, or 3). See *Port ID Numbering*, page 16 for details. Replace the **n** with the appropriate Port ID when entering Hotkey combinations.

N-Key Rollover Keyboard Supporting Function

To enable/disable N-key rollover keyboard supporting function, do the following:

1. Invoke HSM (see page 22).
2. Press **[K] [Enter]**.

Note: If you encounter any problem when using the BIOS when your computer is starting up, please turn off the N-Key rollover keyboard supporting function and then try again.

Switching Mode Selection

This hotkey allows you to select an appropriate switching mode between Normal Switching Mode or Fast Switching Mode.

Note: This hotkey will only be available with CS1953's firmware version v1.0.068 or higher.

To change the switching mode, do the following:

1. Invoke HSM (see page 22).
2. Press and release **[P] [n] [Enter]**. The n represents the appropriate Function key (see table below).

| Function Key | Operation |
|---------------------|--|
| [1] | Sets the KVM to Normal Switching Mode (Default). |
| [2] | Sets the KVM to Fast Switching Mode. |

Note: The configuration of Fast Switching Mode might not work with some monitors. If your video output does not display successfully or work properly, please use the default Normal Switching Mode instead.

HSM Summary Table

After invoking HSM (see page 22), key in one of the following keys to perform the corresponding function:

| Key | Function |
|--|--|
| [F1] | Sets the keyboard and mouse to SPC mode so that it can work under special operating systems as a standard (104 key) keyboard and mouse. |
| [F2] | Enables Mac keyboard emulation. |
| [F3] | Enables Sun keyboard emulation. |
| [F4] | Print the switch's current settings via a text editor or word processor. |
| [F5] | Performs a USB keyboard and mouse reset. |
| [F6] [n][n] [Enter] | Sets the keyboard language layout. Where nn is a two digit number that represents the keyboard language code (US English: 33, French: 08, German: 09, Japanese: 15). |
| [F10] | Enables Windows keyboard emulation. |
| [B] | Enables/disables the buzzer. |
| [E] | Turns the Power-on-Detection function on/off. |
| [H] | Toggles between the default and alternate HSM invocation keys. |
| [K] [Enter] | Enables/disables N-key rollover keyboard supporting function. |
| [M] | Enables/disables mouse emulation. |
| [N] | Enables/disables keyboard emulation. |
| [Q] [n] [Enter] | Enables/disables specific PC port monitor re-detection function. The n stands for the computer's Port ID number (1, 2, or 3) |
| [R] [Enter] | Resets the Hotkey settings to their default status. |
| [S] | Toggles between the default and alternate manual port selection pushbutton settings. |
| [T] | Toggles between the default and alternate Port Switching keys. |
| [u] [p] [g] [r] [a] [d] [e] [Enter] | Invokes Firmware Upgrade Mode. |









| Key | Function |
|---------------------|---|
| [W] | Enables/disables Mouse Port Switching. When enabled, click the mouse wheel twice to switch ports. Mouse emulation must be enabled. |
| [X] [Enter] | Enables/disables Hotkey Port Switching. |
| [P] [n] [Enter] | Sets the KVM switching mode. <ul style="list-style-type: none">◆ n = 1, sets the KVM to Normal Switching Mode.◆ n = 2, sets the KVM to Fast Switching Mode. Note: This hotkey will only be available with CS1953's firmware version v1.0.068 or higher. |
| [Esc] or [Spacebar] | Quits setting mode. |

Chapter 5

Keyboard Emulation

Mac Keyboard







The PC compatible (101/104 key) keyboard can emulate the functions of the Mac keyboard. The emulation mappings are listed in the table below.

| PC Keyboard | Mac Keyboard |
|--|---|
| [Shift] | Shift |
| [Ctrl] | Ctrl |
|  |  |
| [Ctrl] [1] |  |
| [Ctrl] [2] |  |
| [Ctrl] [3] |  |
| [Ctrl] [4] |  |
| [Alt] | Alt |
| [Print Screen] | F13 |
| [Scroll Lock] | F14 |
|  | = |
| [Enter] | Return |
| [Backspace] | Delete |
| [Insert] | Help |
| [Ctrl]  | F15 |

Note: When using key combinations, press and release the first key (Ctrl), then press and release the activation key.

Sun Keyboard

The PC compatible (101/104 key) keyboard can emulate the functions of the Sun keyboard when the control key [Ctrl] is used in conjunction with other keys. The corresponding functions are shown in the table below.

| PC Keyboard | Sun Keyboard |
|---|---|
| [Ctrl] [T] | Stop |
| [Ctrl] [F2] | Again |
| [Ctrl] [F3] | Props |
| [Ctrl] [F4] | Undo |
| [Ctrl] [F5] | Front |
| [Ctrl] [F6] | Copy |
| [Ctrl] [F7] | Open |
| [Ctrl] [F8] | Paste |
| [Ctrl] [F9] | Find |
| [Ctrl] [F10] | Cut |
| [Ctrl] [1] |  |
| [Ctrl] [2] |  |
| [Ctrl] [3] |  |
| [Ctrl] [4] |  |
| [Ctrl] [H] | Help |
|  | Compose |
|  |  |

Note: When using key combinations, press and release the first key (Ctrl), then press and release the activation key.

Chapter 6

The Firmware Upgrade Utility

The Windows-based Firmware Upgrade Utility (FWUpgrade.exe) provides a smooth, automated process for upgrading the CS1953's firmware.

The Utility comes as part of a Firmware Upgrade Package that is specific for each device. New firmware upgrade packages are posted on our website as new firmware revisions become available. Check the website regularly to find the latest packages and information relating to them:

<http://www.aten.com/global/en/support-and-downloads/downloads/>

Before You Begin

To prepare for the firmware upgrade, do the following:

1. From a computer that is not part of your KVM installation, go to our [Aten Support & Download → Downloads](#) site and choose the model name that relates to your device (CS1953) to get a list of available Firmware Upgrade Packages.
2. Choose the Firmware Upgrade Package you want to install (usually the most recent), and download it to your computer.
3. Disconnect the CS1953 from your KVM installation and remove all cable connections, including the power adapter.

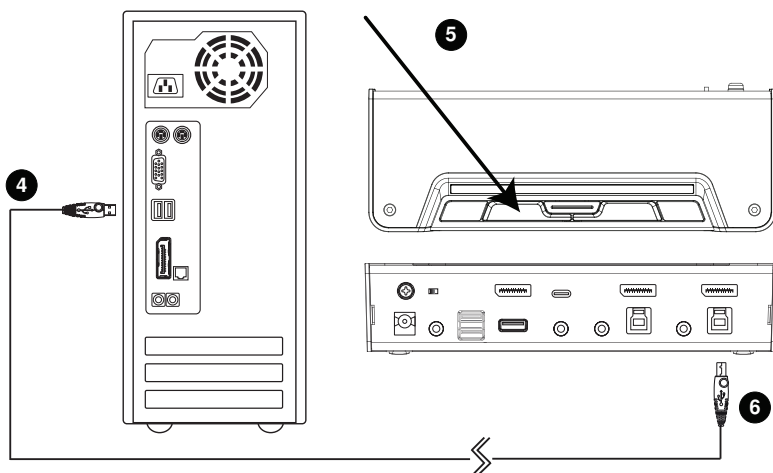

4. Connect the USB Type-A connector to a USB Type-A port on the computer.
5. Press and hold port selection pushbutton 1.
6. While holding port selection pushbutton 1, connect the USB Type-B connector into the CPU 1 from the KVM ports section. The front panel LEDs flash orange together to indicate Firmware Upgrade Mode is in effect.

You can also connect a keyboard to the console port and invoke the Firmware Upgrade Mode via hotkey. See *Firmware Upgrade Mode*, page 25.

Note:

- ◆ The USB cable's USB Type-B connector can be connected to any KVM port section, but the port selection pushbutton must be port 1.
 - ◆ While the CS1953 is in Firmware Upgrade Mode, normal keyboard and mouse functions are suspended. You must complete the firmware upgrade or exit Firmware Upgrade Mode to regain normal control of the console.
-

Starting the Upgrade

To upgrade your firmware:

1. Run the downloaded Firmware Upgrade Package file – either by double clicking the file icon, or by opening a command line and entering the full path to it.

The *Firmware Upgrade Utility* Welcome screen appears:

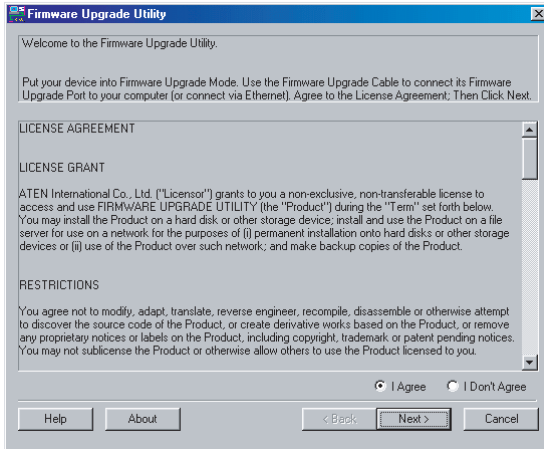

Note: The screens shown in this section are for reference only. The wording and layout of the actual screens put up by the Firmware Upgrade Utility may vary slightly from these examples.

2. Read the License Agreement (enable the *I Agree* radio button).

3. Click **Next** to continue. The Firmware Upgrade Utility main screen appears:

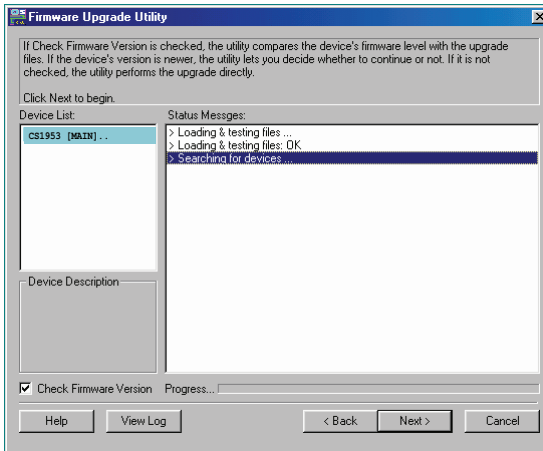

The Utility inspects your installation. All the devices capable of being upgraded by the package are listed in the *Device List* panel.

4. As you select a device in the list, its description appears in the Device Description panel.

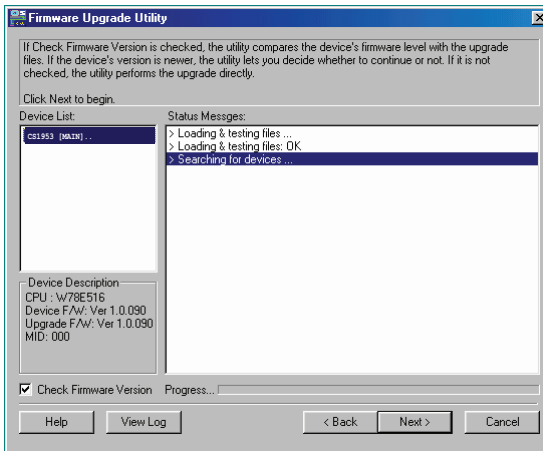

5. After you have made your device selection(s), Click **Next** to perform the upgrade.

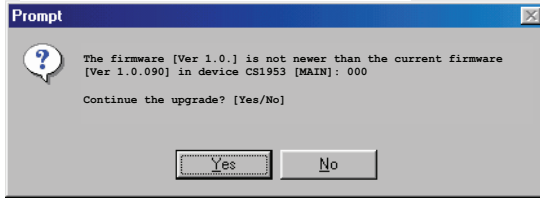

If you enabled *Check Firmware Version*, the Utility compares the device's firmware level with that of the upgrade files. If it finds that the device's version is higher than the upgrade version, it brings up a dialog box informing you of the situation and gives you the option to Continue or Cancel.

If you didn't enable *Check Firmware Version*, the Utility installs the upgrade files without checking whether they are a higher level, or not.

As the Upgrade proceeds, status messages appear in the Status Messages panel, and the progress toward completion is shown on the *Progress* bar.

Upgrade Succeeded

After the upgrade has completed, a screen appears to inform you that the procedure was successful:

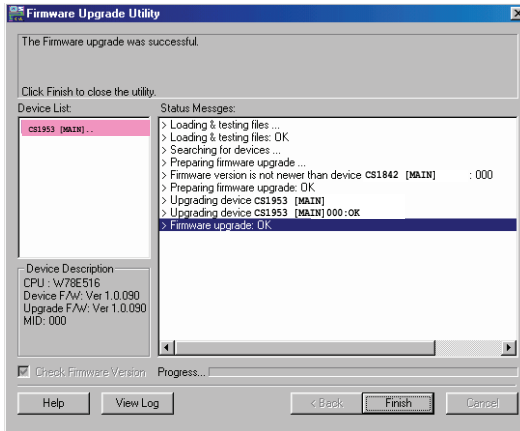

Click **Finish** to close the Firmware Upgrade Utility.

After a successful completion, the switches exit Firmware Upgrade Mode, and reset themselves.

Upgrade Failed

If the *Upgrade Succeeded* screen doesn't appear, it means that the upgrade failed to complete successfully, and you should repeat the upgrade procedure from the beginning.

Safety Instructions

- ◆ Read all of these instructions. Save them for future reference.
- ◆ This device is for indoor use only.
- ◆ Follow all warnings and instructions marked on the device.
- ◆ Do not place the device on any unstable surface (cart, stand, table, etc.). If the device falls, serious damage will result.
- ◆ Do not use the device near water.
- ◆ Do not place the device near, or over, radiators or heat registers.
- ◆ The device cabinet is provided with slots and openings to allow for adequate ventilation. To ensure reliable operation, and to protect against overheating, these openings must never be blocked or covered.
- ◆ The device should never be placed on a soft surface (bed, sofa, rug, etc.) as this will block its ventilation openings. Likewise, the device should not be placed in a built in enclosure unless adequate ventilation has been provided.
- ◆ Never spill liquid of any kind on the device.
- ◆ Unplug the device from the wall outlet before cleaning. Do not use liquid or aerosol cleaners. Use a damp cloth for cleaning.
- ◆ The device should be operated from the type of power source indicated on the marking label. If you are not sure of the type of power available, consult your dealer or local power company.
- ◆ Avoid circuit overloads. Before connecting equipment to a circuit, know the power supply's limit and never exceed it. Always review the electrical specifications of a circuit to ensure that you are not creating a dangerous condition or that one doesn't already exist. Circuit overloads can cause a fire and destroy equipment.
- ◆ To prevent damage to your installation, it is important that all devices are properly grounded.
- ◆ Do not allow anything to rest on the power cord or cables. Route the power cord and cables so that they cannot be stepped on or tripped over.
- ◆ Position system cables and power cables carefully; Be sure that nothing rests on any cables.

- ◆ Never push objects of any kind into or through cabinet slots. They may touch dangerous voltage points or short out parts resulting in a risk of fire or electrical shock.
- ◆ Do not attempt to service the device yourself. Refer all servicing to qualified service personnel.
- ◆ If the following conditions occur, unplug the device from the wall outlet and bring it to qualified service personnel for repair.
 - ◆ The power cord or plug has become damaged or frayed.
 - ◆ Liquid has been spilled into the device.
 - ◆ The device has been exposed to rain or water.
 - ◆ The device has been dropped, or the cabinet has been damaged.
 - ◆ The device exhibits a distinct change in performance, indicating a need for service.
 - ◆ The device does not operate normally when the operating instructions are followed.
- ◆ Only adjust those controls that are covered in the operating instructions. Improper adjustment of other controls may result in damage that will require extensive work by a qualified technician to repair.
- ◆ Do not connect the RJ-11 connector marked “UPGRADE” to a public telecommunication network.

Troubleshooting

Overview

Operation problems can be due to a variety of causes. The first step in solving them is to make sure that all cables are securely attached and seated completely in their ports.

In addition, updating the product's firmware may solve problems that have been discovered and resolved since the prior version was released. If your product is not running the latest firmware version, we strongly recommend that you upgrade. See Chapter 6, *The Firmware Upgrade Utility*, for upgrade details.

| Symptom | Possible Cause | Action |
|--|--|--|
| Mouse and/or Keyboard not responding. | Improper mouse and/or keyboard reset. | Unplug the cable(s) from the console port(s), then plug it/them back in. |
| | CS1953 needs to be reset. | Power off all devices on the installation (see safety note, top of page 9); power off the CS1953; wait five seconds; then power up |
| USB devices not responding. | USB ports need to reset. | Unplug the device's USB cable from the USB port on the CS1953's rear panel, then plug it back in. |
| | PC or OS does not support USB 2.0/3.0. | The CS1953 has a built-in USB 3.0 hub, so will not support PCs or OS that do not support USB 2.0/3.0. For an OS that does not support USB 2.0, keyboard and mouse functions can be reset using the [F1] Hotkey function. See page 29. |
| Device not recognized (Windows). | Windows timing problem. | <ol style="list-style-type: none"> 1. Unplug the KVM cable from the computer's USB port. 2. Go into Windows' <i>System Settings</i> and remove the <i>Unknown Device</i> entry. 3. Plug the KVM cable back in. Windows will now recognize the device. |
| The Front Panel Pushbutton Combo key doesn't work after its set. | Some Hotkeys are not supported as front panel pushbutton combo keys. | The [X] [Enter] , [R] [Enter] , and [upgrade] [Enter] Hotkeys can not be set as a front panel pushbutton combo key. Select a different Hotkey to use. |

Technical Support

Technical support is available both by email and online (with a browser over the web):

International

- ◆ For online technical support – including troubleshooting, documentation, and software updates: <http://support.aten.com>
- ◆ For telephone support, see *Telephone Support*, page iv:

North America

| | | |
|--------------------------|--|---|
| Email Support | | support@aten-usa.com |
| Online Technical Support | Troubleshooting Documentation Software Updates | http://www.aten-usa.com/support |
| Telephone Support | | 1-888-999-ATEN ext 4988 1-949-428-1111 |

When you contact us, please have the following information ready beforehand:

- ◆ Product model number, serial number, and date of purchase.
- ◆ Your computer configuration, including operating system, revision level, expansion cards, and software.
- ◆ Any error messages displayed at the time the error occurred.
- ◆ The sequence of operations that led up to the error.
- ◆ Any other information you feel may be of help.

Specifications

| Function | | CS1953 | |
|----------------------|------------------------|--|---|
| Computer Connections | Direct | 3 | |
| Port Selection | | Pushbutton, Hotkey, Remote Port Selector, Mouse* | |
| Connectors | Console Ports | Keyboard | 1 x USB Type-A Female |
| | | Mouse | 1 x USB Type-A Female |
| | | Video | 1 x DisplayPort Female (Black) |
| | | Speakers | 2 x 3.5mm Audio Jack Female (Green; 1 x front, 1 x rear) |
| | KVM Ports | KB / Mouse | 2 x USB 3.1 Gen 1 Type B Female (Blue) |
| | | Video | 2 x DisplayPort Female (Black) |
| | | USB-C Device | 1 x USB-C Female |
| | | Speakers | 3 x 3.5mm Audio Jack Female (Green) |
| | Remote Port Selector | | 1 x 2.5mm Audio Jack Female (Black) |
| | Power | | 1 x DC Jack |
| | USB Hub | | 2 x USB 3.1 Gen 1 Type-A Female (Blue; 1 x front, 1 x rear) |
| Switches | Selected | 3 x Pushbutton | |
| | Mode Switch | 1 x Slide switch | |
| LED | KVM | 3 (Orange) | |
| | Audio | 3 (Green) | |
| | USB Link | 3 (Green) | |
| Emulation | KB / Mouse | USB | |
| Video | | 4096 x 2160 @ 60 Hz | |
| Scan Interval | | 1 – 99 seconds (default: 5 sec) | |
| Power Consumption | | DC 12V:5.78W:269BTU | |
| Environment | Operating Temp. | 0–50°C | |
| | Storage Temp. | -20–60°C | |
| | Humidity | 0–80% RH, Non-condensing | |
| Physical Properties | Housing | Metal + Plastic | |
| | Weight | 0.50 kg (1.1 lb) | |
| | Dimensions (L x W x H) | 20.63 x 7.54 x 4.40 cm (8.12 x 2.97 x 1.73 in) | |

* Port switching only works with 3-key USB mouse wheel in emulation mode.

Hotkey Default Settings

The hotkey factory default settings are as follows:

| Setting | Default |
|---------------------------------------|-----------------------------|
| Port Switching | [Scroll Lock] [Scroll Lock] |
| Invoking HSM | [Number Lock] [-] |
| Keyboard Emulation | Enabled |
| Mouse Emulation | Enabled |
| Auto Scan Interval | 5 Seconds |
| Mouse Wheel Switching | Disabled |
| Power On Detection | Enabled |
| Keyboard Operating Platform | Windows |
| Keyboard Language Layout | English |
| Beeper | Enabled |
| Specific PC Port Monitor Re-detection | Disabled |
| Port Switching Keys | Enabled |
| N-Key Rollover Keyboard | Enabled |

ATEN Standard Warranty Policy

Limited Hardware Warranty

ATEN warrants its hardware in the country of purchase against flaws in materials and workmanship for a Warranty Period of two [2] years (warranty period may vary in certain regions/countries) commencing on the date of original purchase. This warranty period includes the [LCD panel of ATEN LCD KVM switches](#). For UPS products, the device warranty is two [2] years but battery is one [1] year. Select products are warranted for an additional year (see [A+ Warranty](#) for further details). Cables and accessories are not covered by the Standard Warranty.

What is covered by the Limited Hardware Warranty

ATEN will provide a repair service, without charge, during the Warranty Period. If a product is defective, ATEN will, at its discretion, have the option to (1) repair said product with new or repaired components, or (2) replace the entire product with an identical product or with a similar product which fulfills the same function as the defective product. Replaced products assume the warranty of the original product for the remaining period or a period of 90 days, whichever is longer. When the products or components are replaced, the replacing articles shall become customer property and the replaced articles shall become the property of ATEN.

To learn more about our warranty policies, please visit our website:
<http://www.aten.com/global/en/legal/policies/warranty-policy/>

Released: 2023-06-28

© Copyright 2023 ATEN® International Co., Ltd.

ATEN and the ATEN logo are registered trademarks of ATEN International Co., Ltd. All rights reserved.
All other brand names and trademarks are the registered property of their respective owners.

ATEN International Co., Ltd., 3F, No. 125, Sec. 2, Datung Rd., Sijhih District, New Taipei City 221, Taiwan
Phone: 886-2-8692-6789 Fax: 886-2-8692-6767 TECHNICAL SUPPORT CENTER: 886-2-8692-6959