



Datenblatt - Fiche technique - Data sheet

**11.04.5892**



ROLINE GOLD Monitorkabel DVI-HDMI, ST-ST, (24+1) dual link, 3,0 m

ROLINE GOLD Câble pour écran DVI-HDMI, M-M, (24+1) dual link, 3,0 m

ROLINE GOLD Monitor Cable, DVI (24+1) - HDMI, Dual Link, M/M, 3.0 m

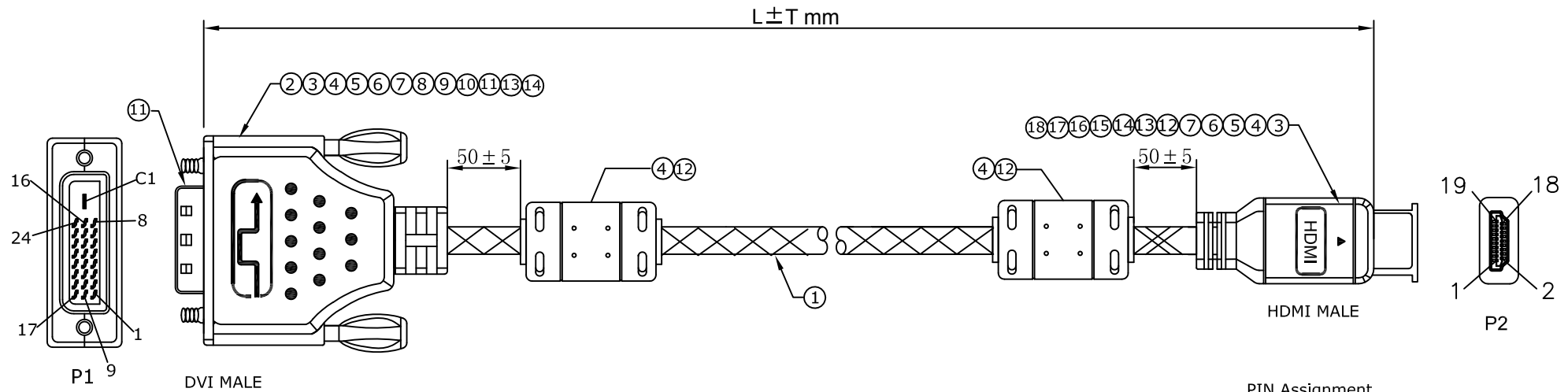

**ELECTRICAL TEST:**

- 1.100% OPEN SHORT & MIS WIRE TEST
- 2.CONTACT RESISTANCE:2 OHM(MAX)
- 3.INSULATION RESISTANCE:10M OHM(MIN)
- 4.HI-POT TEST:DC 300V/10ms

Part No.	Length
11.04.5890	1000±30MM
11.04.5891	2000±30MM
11.04.5892	3000±50MM

**PIN Assignment**

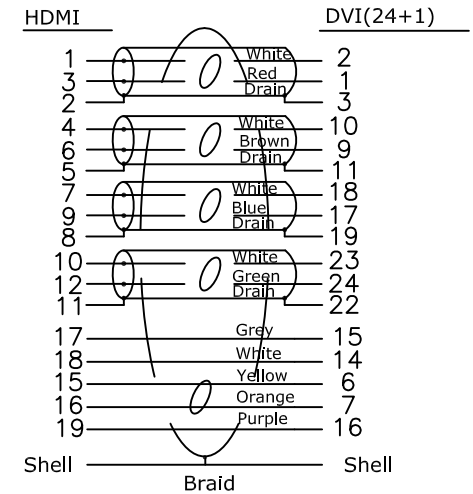

18	HDMI 20# BLACK ABS HOOD	1	pcs
17	HDMI M TRANSPARENT DUST COVER	1	pcs
16	HDMI # 20 die golden shiny aluminum alloy shell Single radium vulture HDMI LOGO	1	pcs
15	HDMI M 19P BLACK INSULATION SHELL PLATED:GOLD CONTACT:G/F	1	pcs
14	W: 22 mm double guide copper foil	0.24	M
13	Nickel plating line buckle OD:7.3 (YB07080702)	2	pcs
12	CORE 28.5*17.5*9.5MM	2	pcs
11	DVI M TRANSPARENT DUST COVER	1	pcs
10	DVI 24 # mold golden shiny aluminum alloy shell radium vulture DVI LOGO	1	pcs
9	DVI 24 # mold golden shiny aluminum alloy shell radium vulture DVI LOGO	1	pcs
8	#4-40UNC 4*38.5 Gold-plated screws	4	pcs
7	TUBE BLACK : ϕ 1.5*22mm THICK	0.044	m
6	TUBE BLACK : ϕ 1.0*12mm THIN	0.168	m
5	TUBE BLACK ϕ2.0*10mmTHIN	0.14	m
4	45P BLACK PVC ROHS	40	g
3	TRANSPARENT PE	6	g
2	DVI(24+1) M SOLDER TYPE,GOLD PLATED,BLACK INSULATION	1	pcs
1	(1P*30#+D+AL+ML)*4+1P*30#+3C*30#+AL+D+B(50% AL) OD 5.5mm, PVC Jacket BLACK nylon sleeve	L	M
NO	<b>DESCRIPTION</b>	Q'TY	UNIT

REV.	ECN	DESCRIPTION	DATE	NAME	
⊕ ⊖	TOLERANCE INCHES M/M	<b>SECOMP</b> ROLINE Gold DVI/HDMI Cable, M/M			
.X	.015 .30				
.XX	.010 .10				
.XXX	.005 .05				
DRAWN BY	ZhouWenLong	P/N: 11.04.5890 /11.04.5891/11.04.5892			
CHECK BY		SCALE	NONE	DRAWING NO:	REV A01
APPD BY		UNIT	MM		
		DATE	2017.03.15		1/1