

NETGEAR®

ProSAFE Dual-Band Wireless AC Access Points WAC720 and WAC730

Reference Manual



October 2015
202-11607-01

350 East Plumeria Drive
San Jose, CA 95134
USA

Support

Thank you for purchasing this NETGEAR product. You can visit www.netgear.com/support to register your product, get help, access the latest downloads and user manuals, and join our community. We recommend that you use only official NETGEAR support resources.

Conformity

For the current EU Declaration of Conformity, visit http://kb.netgear.com/app/answers/detail/a_id/11621.

Compliance

For regulatory compliance information, visit <http://www.netgear.com/about/regulatory>.

See the regulatory compliance document before connecting the power supply.

Trademarks

© NETGEAR, Inc., NETGEAR and the NETGEAR Logo are trademarks of NETGEAR, Inc. Any non-NETGEAR trademarks are used for reference purposes only.

Contents

Chapter 1 Hardware Setup

Unpack Your Access Point	7
Hardware Description	7
Top Panel	7
Rear Panel	9
Bottom Panel With Product Label	10

Chapter 2 Initial Setup

What You Need Before You Begin	11
System Requirements	11
Wireless Equipment Placement and Range Guidelines	11
Ethernet Cabling Requirements	12
LAN Configuration Requirements	12
Hardware Requirements for Computers on Your LAN	13
Operating Frequency Guidelines	13
Requirements for Entering IP Addresses	13
Install and Configure the Wireless Access Point	14
Connect the Wireless Access Point to a Computer	14
Log In to the Wireless Access Point	15
Configure Basic General System Settings and Time Settings	16
Configure the IPv4 Settings	18
Configure the Basic Wireless Settings	19
Test Basic Wireless Connectivity	25
Mount the Wireless Access Point	25
Ceiling Installation	26
Wall Installation	28

Chapter 3 Wireless Configuration and Security

Wireless Data Security Options	31
Security Profiles	33
Configure and Enable Security Profiles	35
Configure RADIUS Server Settings	41
Restrict Wireless Access by MAC Address	44
Enable Rogue AP Detection	45
Schedule the Wireless Radios to Be Turned Off	46
Configure Basic Wireless Quality of Service	47

Chapter 4 Management and Monitoring

Enable Remote Management	50
SNMP Management	50
Secure Shell and Telnet Management	51
Upgrade the Wireless Access Point Software	52
Web Browser Upgrade Procedure	53
TFTP Server Upgrade Procedure	54
Manage the Configuration File or Reset to Factory Defaults	54
Save the Configuration	55
Restore the Configuration	55
Restore the Wireless Access Point to the Factory Default Settings	56
Reboot the Wireless Access Point Without Restoring the Default Configuration	57
Change the Administrator Password	58
Manage User Accounts	58
Enable the Syslog Server	60
Monitor the Wireless Access Point	61
View System Information	61
Monitor Wireless Stations	64
View the Activity Log	65
Traffic Statistics	66
Enable and Configure Ensemble Mode	67
Configure Ensemble Mode	68
Manage an Ensemble	68
Monitor an Ensemble	70

Chapter 5 Advanced Configuration

Configure IPv6 Settings	72
Configure the IPv6 Settings	72
Configure Spanning Tree Protocol, 802.1Q VLAN, and Link Layer Discovery Protoco	73
Configure STP and VLANs	73
Configure Ethernet LLDP	75
Configure Bonjour	76
Configure Advanced Wireless Settings	76
Configure Advanced Quality of Service Settings	79
Configure Quality of Service Policies	81
Configure Captive Portal	87
Configure Wireless Bridging	89
Configure a Point-to-Point Wireless Network	89
Configure a Point-to-Multipoint Wireless Network	92
Configure the Wireless Access Point to Repeat the Wireless Signal Using Point-to-Multipoint Bridge Mode	94

Chapter 6 Troubleshooting

Basic Functioning	99
-----------------------------	----

Verify the Correct Sequence of Events at Start Up.	99
No LEDs Are Lit on the Wireless Access Point.	99
The Active LED or the LAN LED Is Not Lit.	100
The WLAN LED Does Not Light Up.	100
You Cannot Access the Internet or the LAN from a Wireless-Capable Computer	101
You Cannot Configure the Wireless Access Point from a Browser.	101
When You Enter a URL or IP Address a Time-Out Error Occurs.	102
Troubleshoot a TCP/IP Network Using the Ping Utility	102
Test the LAN Path to Your Wireless Access Point.	103
Test the Path from Your Computer to a Remote Device.	104
Problems with Date and Time	104
Use the Packet Capture Tool	105

Appendix A Supplemental Information

Technical Specifications	107
Factory Default Settings	110

Hardware Setup

1

This chapter covers the following topics:

- *Unpack Your Access Point*
- *Hardware Description*

For more information about the topics covered in this manual, visit the support website at <http://support.netgear.com>.

Firmware updates with new features and bug fixes are made available from time to time at downloadcenter.netgear.com. Some products can regularly check the site and download new firmware, or you can check for and download new firmware manually. If the features or behavior of your product does not match what is described in this guide, you might need to update your firmware.

Unpack Your Access Point

Your package contains the following items:

- ProSAFE Dual-Band Wireless AC Access Point
- Straight-through Category 5 Ethernet cable
- Installation guide
- Ceiling-mount kit

Contact your reseller or customer support in your area if any parts are missing or damaged.

Visit the NETGEAR website at support.netgear.com/general/contact/default.aspx for the telephone number of customer support in your area.

Hardware Description

The following sections describe the top and rear hardware functions of the wireless access point.

- *Top Panel*
- *Rear Panel*
- *Bottom Panel With Product Label*

Top Panel

The LEDs of the wireless access point are described in the following figure and table:

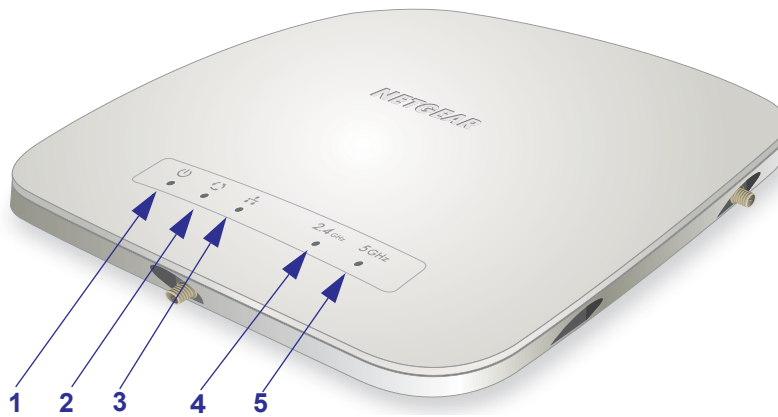





Figure 1. Top panel

Table 1. Top panel LEDs

Item	LED	Description		
1		Power/Test	Off	Power is off.
			On (green)	Power is on.
			Amber, then blinking green	A self-test is running or software is being loaded. During startup, the LED is first steady amber, then goes off, and then blinks green before turning steady green after about 45 seconds. If after one minute the LED remains amber or continues to blink green, it indicates a system fault.
2		Active	Off	No Ethernet traffic is detected, or no link is detected.
			On or blinking (green)	Ethernet traffic is detected.
3		LAN	Off	A 10 Mbps or no link is detected on LAN port.
			Amber	A 100 Mbps link is detected on LAN port.
			Green	A 1000 Mbps link is detected on LAN port.
4	2.4 Ghz	WLAN	Off	The Wireless 802.11b/g/n (2.4 GHz) LAN is not ready, or no wireless activity is detected.
			On or blinking (green)	The Wireless 802.11b/g/n (2.4 GHz) LAN is ready, or wireless activity is detected.
5	5 Ghz	WLAN	Off	The Wireless 802.11n/a (5 GHz) LAN is not ready, or no wireless activity is detected.
			On or blinking (green)	The Wireless 802.11n/a (5 GHz) LAN is ready, or wireless activity is detected.

Rear Panel

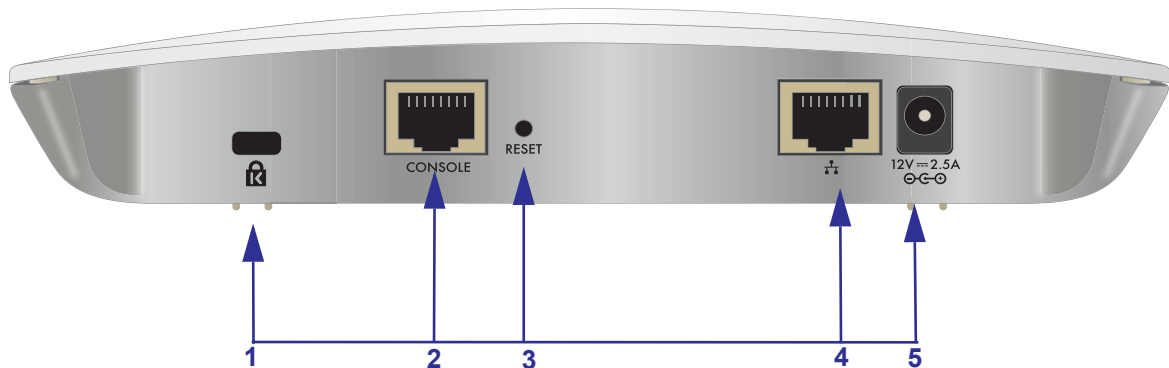

Figure 2. Rear panel

The rear panel components of the wireless access point, from left to right, are described in the following list:

1. Cable security lock receptacle for an optional lock.
2. Console port for connecting to an optional console terminal. The port provides an RJ-45 connector and supports the following settings: 115200 K default baud rate, 8 data bits, no (N) parity bit, and one (1) stop bit.
3. Factory default **Reset** button. Using a sharp object, press and hold this button for about five seconds to reset the wireless access point to factory defaults settings. All configuration settings are lost, and the default password is restored. For more information, see [Restore the Wireless Access Point to the Factory Default Settings](#) on page 56.
4. 10/100/1000BASE-T Gigabit Ethernet (RJ-45) port with Auto Uplink (Auto MDI-X) with IEEE 802.3af Power over Ethernet (PoE) support for connection to a switch or router.
5. Power socket for an optional 12 VDC, 2.5A power adapter.

Note: The WAC720 access point can support up to two optional 2.4GHz/5GHz dual band antennas. The WAC730 access point can support up to three optional 2.4GHz/5GHz dual band antennas.

Bottom Panel With Product Label

The product label on the bottom of the wireless access point's enclosure displays factory default settings, regulatory compliance, and other information:

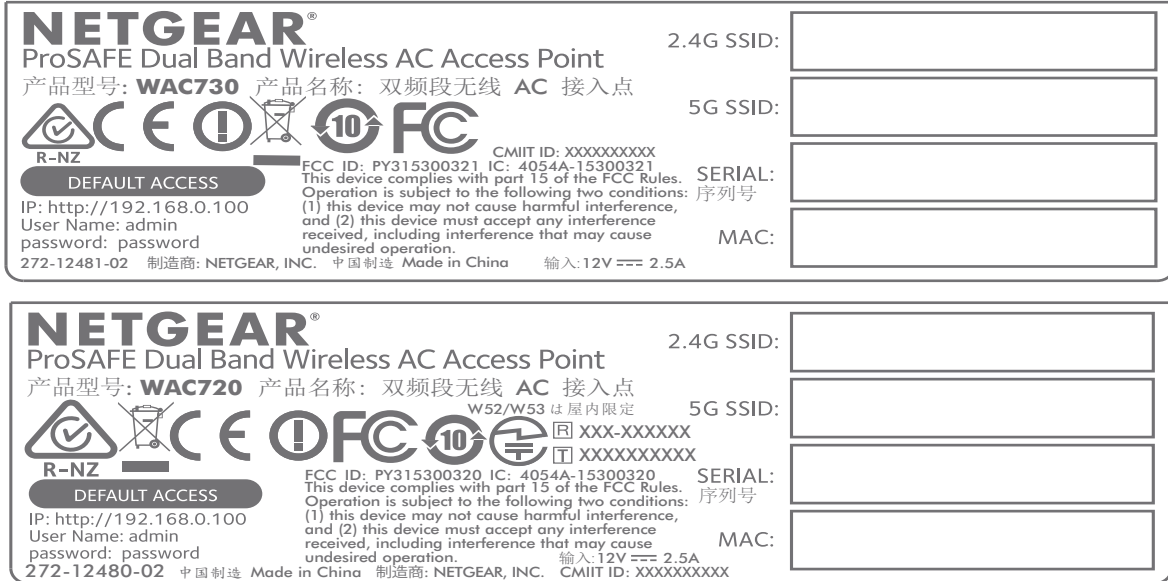

Figure 3. Product label

2 Initial Setup

This chapter covers the following topics:

- *What You Need Before You Begin*
- *Install and Configure the Wireless Access Point*
- *Test Basic Wireless Connectivity*
- *Mount the Wireless Access Point*

What You Need Before You Begin

You must consider the following guidelines and requirements before you can set up your wireless access point.

System Requirements

Before installing the access point, make sure that your system includes the following:

- A 10/100/1000 Mbps local area network device such as a hub or switch
- The Category 5 UTP straight-through Ethernet cable with RJ-45 connector included in the package, or one like it
- A PoE switch or a 12V, 2.5A DC power source
- A web browser for configuration
- At least one computer with the TCP/IP protocol installed
- 802.11bg/ng/bgn-compliant or 802.11a/a-na-ac-compliant devices

Wireless Equipment Placement and Range Guidelines

The range of your wireless connection can vary significantly based on the location of the wireless access point. The latency, data throughput performance, and power consumption of wireless adapters also vary depending on your configuration choices.

Note: Failure to follow these guidelines can result in significant performance degradation or inability to connect wirelessly to the wireless access point. For complete performance specifications, see [Appendix A, Supplemental Information](#).

Note: Before you position and mount the wireless access point at its permanent position, first configure the wireless access point and test the computers on your LAN for wireless connectivity as explained in this chapter.

For best results, place your wireless access point according to the following general guidelines:

- Near the center of the area in which the wireless devices will operate.
- In an elevated location such as a high shelf where the wirelessly connected devices have line-of-sight access (even if through walls).
- Away from sources of interference, such as computers, microwaves ovens, and 2.4 GHz cordless phones.
- Away from large metal surfaces or water.
- Placing an external antenna in a vertical position provides best side-to-side coverage. Placing an external antenna in a horizontal position provides best up-and-down coverage. (An external antenna does not come standard with the wireless access point.)
- If you are using multiple wireless access points, it is better if adjacent wireless access points use different radio frequency channels to reduce interference. The recommended channel spacing between adjacent wireless access points is five channels (for example, use Channels 1 and 6, or 6 and 11, or 1 and 11).

The time it takes to establish a wireless connection can vary depending on both your security settings and placement.

Ethernet Cabling Requirements

The wireless access point connects to your LAN using twisted-pair Category 5 Ethernet cable with RJ-45 connectors.

LAN Configuration Requirements

For the initial configuration of your wireless access point, you must connect a computer to the wireless access point.

Hardware Requirements for Computers on Your LAN

To connect to the wireless access point on your network, an 802.11bg/ng/bgn or 802.11a/a-na-ac wireless adapter must be installed on each computer. We recommend using the wireless access point with computers with the NETGEAR A6210 WiFi USB Adapter installed.

Operating Frequency Guidelines

You do not need to change the operating frequency (channel) unless you notice interference problems or you place the wireless access point near another wireless access point. If you do change the operating frequency, observe the following guidelines:

- Wireless access points use a fixed channel. You can select a channel that provides the least interference and best performance. In the United States and Canada, 11 channels are available.
- If you use multiple wireless access points, it is better if adjacent wireless access points use different channels to reduce interference. The recommended channel spacing between adjacent wireless access points is five channels (for example, use Channels 1 and 6, or 6 and 11).
- In infrastructure mode (which is the default mode for the wireless access point), wireless stations normally scan all channels, looking for a wireless access point. If more than one wireless access point can be used, the one with the strongest signal is used. This is possible only if the wireless access points use the same SSID.

Requirements for Entering IP Addresses

IP addresses assigned to the access points must follow the following requirements for IPv4 and IPv6 addresses.

IPv4

The fourth octet of an IP address must be between 0 and 255 (both inclusive). This requirement applies to any IP address that you enter on the wireless access point's web management interface.

IPv6

IPv6 addresses are denoted by eight groups of hexadecimal quartets that are separated by colons. Any four-digit group of zeroes within an IPv6 address can be reduced to a single zero or altogether omitted.

The following errors invalidate an IPv6 address:

- More than eight groups of hexadecimal quartets
- More than four hexadecimal characters in a quartet
- More than two colons in a row

Install and Configure the Wireless Access Point

Install and configure your wireless access point in the order of the following sections:

1. *Connect the Wireless Access Point to a Computer*
2. *Log In to the Wireless Access Point*
3. *Configure Basic General System Settings and Time Settings*
4. *Configure the IPv4 Settings*
5. *Configure the Basic Wireless Settings*

Before installing the wireless access point, make sure that your Ethernet network functions. After you connect the wireless access point to the Ethernet network, computers with 802.11b/g/a/n/ac wireless adapters are able to communicate with the Ethernet network.

For this to work correctly, verify that you meet all the system requirements, shown in *Hardware Description* on page 7.

Connect the Wireless Access Point to a Computer

Tip: Before you place the wireless access point in an elevated position that is difficult to reach, first set up and test the wireless access point to verify wireless network connectivity.

➤ **To set up the wireless access point:**

1. Unpack the box and verify the contents.
2. Prepare a computer with an Ethernet adapter.

If this computer is already part of your network, record its TCP/IP configuration settings. Configure the computer with a static IP address of 192.168.0.210 and 255.255.255.0 as the subnet mask.

3. Connect an Ethernet cable from the wireless access point to the computer.
4. Securely insert the other end of the cable into the wireless access point's Ethernet port.
5. Turn on your computer.
6. Connect the wireless access point to a PoE switch or power adapter.

Tip: The wireless access point supports Power over Ethernet (PoE) with power redundancy. If you are using a switch that provides PoE, you do not need to use a power adapter to power the wireless access point. Using PoE can be especially convenient when the wireless access point is installed in a high location far away from a power outlet.

7. Verify the following:



Power/Test LED. The Power/Test LED blinks when the wireless access point is first turned on. (To be exact, during startup, the LED is first steady amber, then goes off, and then blinks green.) After about 45 seconds, the LED stays lit (steady green). If after oneminute the Power/Test LED is not lit or is still blinking, check the connections and see if the power outlet is controlled by a wall switch that is turned off.



Active LED. The Active LED is lit or blinks green when Ethernet traffic is detected.



LAN LED. The LAN LED indicates the LAN speed for LAN port 1: green for 1000 Mbps, amber for 100 Mbps, and no light for 10 Mbps. If the LAN LED is not lit, make sure that the Ethernet cable is securely attached at both ends.



WLAN LED. The 2.4 GHz WLAN LED is lit or blinks green when the wireless LAN (WLAN) is ready.



WLAN LED. The 5 GHz WLAN LED is lit or blinks green when the wireless LAN (WLAN) is ready.

Log In to the Wireless Access Point

The default IP address of your wireless access point is 192.168.0.100. By default, the DHCP client on the wireless access point is enabled. If you have a DHCP server on the network but want to access the access point using the default IP address, you must remove the DHCP server from the network.

➤ **To log in to the wireless access point:**

1. Open a web browser such as Microsoft Internet Explorer 11 or later.
2. Connect to the wireless access point by entering its default address of **192.168.0.100** into your browser (use http and not https).

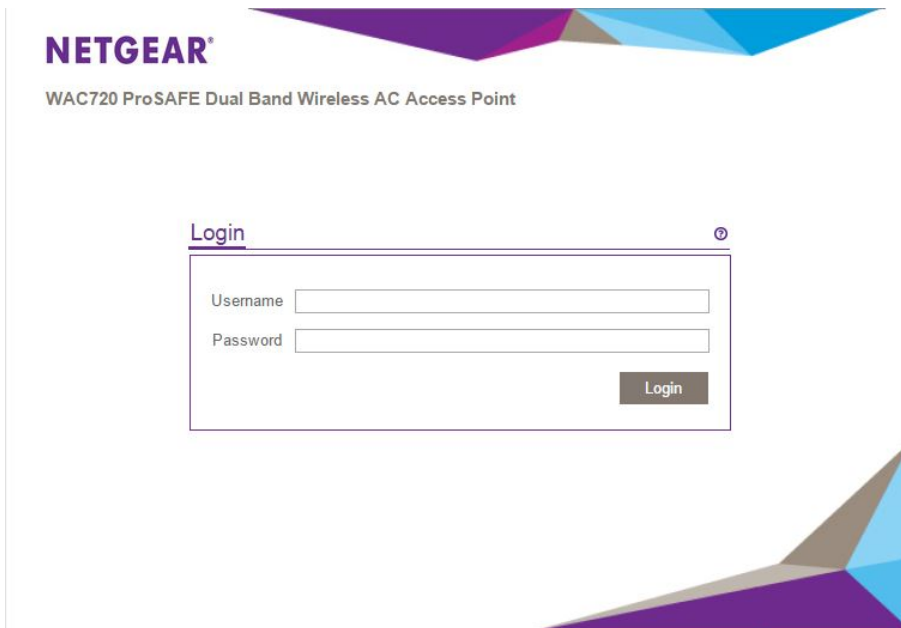

3. Enter the default user name of **admin** and the default password of **password**.
4. Click the **Login** button.

The web browser displays the basic General system settings page under the Configuration tab of the main menu.

Web Management Interface

The navigation tabs across the top of the web management interface provide access to all the configuration functions of the wireless access point and remain constant. The menu items in the blue bar change according to the navigation tab that is selected.

The top right corner of all pages that allow you to make configuration changes show the **Apply** and **Cancel** buttons, and on several pages the **Edit** button.

These buttons provide the following functions:

- **Edit.** Allows you to edit the existing configuration.
- **Cancel.** Cancels all configuration changes that you made on the page.
- **Apply.** Saves and applies all configuration changes that you made on the page.

Configure Basic General System Settings and Time Settings

Note: After you successfully log in to the wireless access point, the basic General system settings page displays.

➤ To configure basic system settings:

1. Select **Configuration > System > Basic > General**.

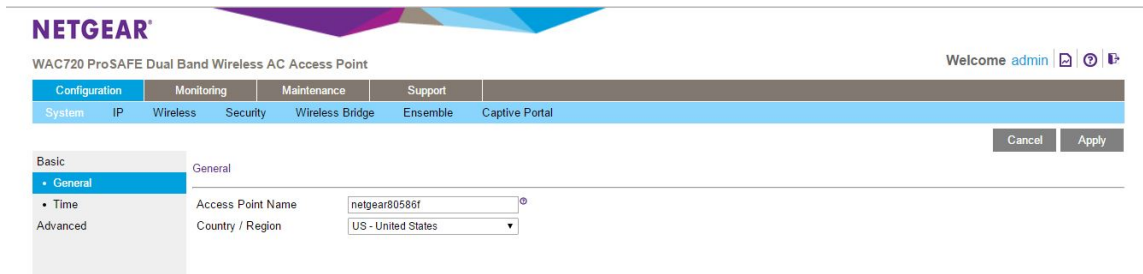

2. Configure the settings as explained in the following table:

Setting	Description
Access Point Name	This unique name is the wireless access point NetBIOS name. The name is printed on the rear label of the wireless access point. The default is netgearxxxxxx, in which xxxxxx represents the last 6 digits of the wireless access point MAC address. You can replace the default name with a unique name up to 15 characters long. The access point name can be retrieved through SNMP.
Country / Region	From the Country / Region menu, select the country where the wireless access point is installed. Note: It might not be legal to operate this wireless access point in a region other than one of those identified in this field.

3. Click the **Apply** button.
Your settings are saved.

➤ To configure time settings:

1. Select **Configuration > System > Basic > Time**.

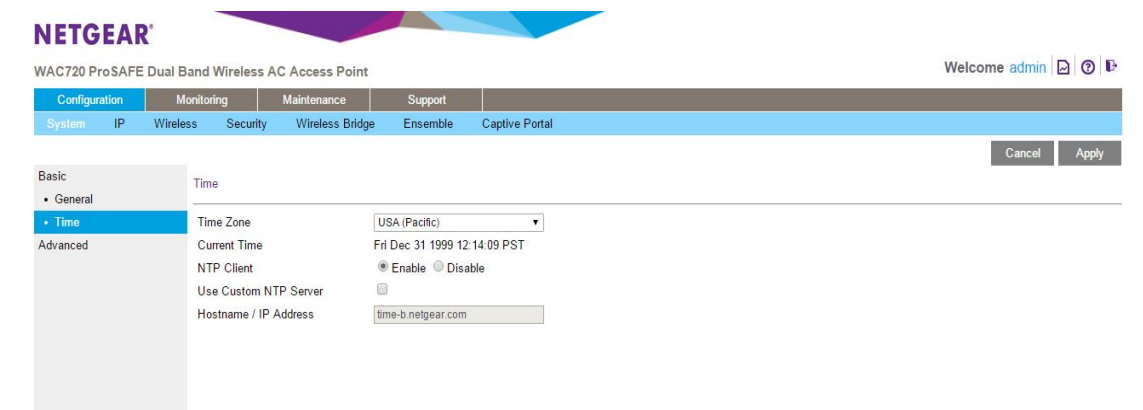

2. Configure the settings as explained in the following table:

Setting	Description	
Time Zone	Select the time zone to match your location.	
Current Time	This is a nonconfigurable field that displays the current date and time.	
NTP Client	Enable the Network Time Protocol (NTP) client to synchronize the time of the wireless access point with an NTP server. By default the Enable radio button is selected.	
Use Custom NTP Server	Select this check box if you want to use a custom NTP server. Note: You need an Internet connection to use an NTP server that is not on your local network.	
	<table border="1"> <tr> <td>Hostname / IP Address</td> <td>Enter the host name or IP address of the custom NTP server. The default is time-b.netgear.com. Note: If you use a host name, make sure that you have configured a DNS server.</td> </tr> </table>	Hostname / IP Address
Hostname / IP Address	Enter the host name or IP address of the custom NTP server. The default is time-b.netgear.com. Note: If you use a host name, make sure that you have configured a DNS server.	

3. Click **Apply** button.

Your settings are saved.

Configure the IPv4 Settings

Note: For information about how to configure the IPv6 settings, see [Configure the IPv6 Settings](#) on page 72.



WARNING:

If you enable the DHCP client, the IP address of the wireless access point changes when you click the **Apply** button, causing you to lose your connection to the wireless access point. You must use the new IP address to reconnect to the wireless access point.

Tip: If you enable the DHCP client on the wireless access point, you can discover the new IP address of the wireless access point by accessing the DHCP server on your LAN, or by using a network IP address scanner application.

➤ **To configure the IPv4 settings:**

1. Select **Configuration > IP > IP Settings**.

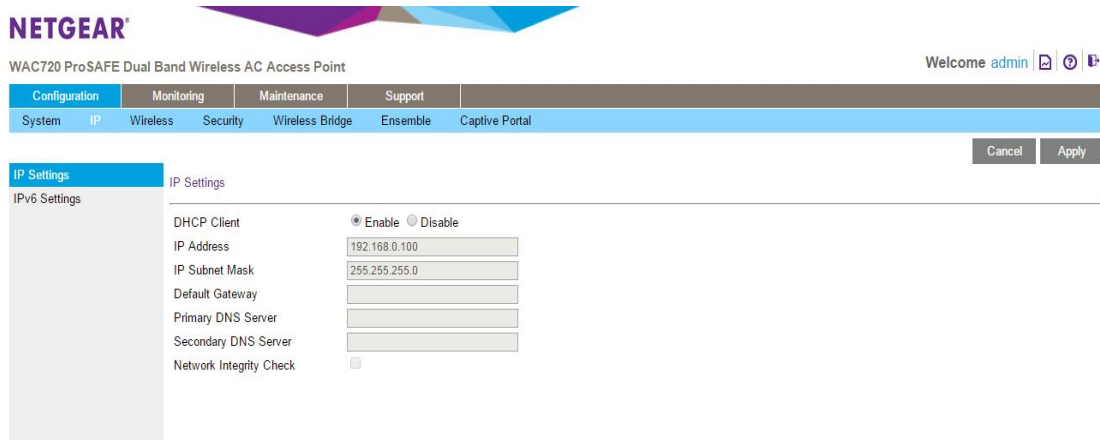

2. Configure the IPv4 settings as explained in the following table:

Setting	Description
DHCP Client	By default, the Dynamic Host Configuration Protocol (DHCP) client is enabled. The wireless access point receives its IP address, subnet mask, and default gateway settings automatically from the DHCP server on your network when you connect the wireless access point to your LAN.
IP Address	Enter the IP address of your wireless access point. The default IP address is 192.168.0.100 . To change the address, enter an unused IP address from the address range used on your LAN, or enable DHCP the server.
IP Subnet Mask	Enter the network number portion of an IP address. Unless you are implementing subnetting, enter 255.255.0.0 as the subnet mask.
Default Gateway	Enter the IP address of the ISP gateway to which the wireless access point connects.
Primary DNS Server	Enter the IP address of the primary and secondary DNS servers. A DNS server is a host on the Internet that translates Internet names (such as www.netgear.com) to numeric IP addresses. Typically your ISP transfers the IP address of one or two DNS servers to your wireless access point during login. If the ISP does not transfer an address, you must obtain it from the ISP and enter it manually in this field.
Secondary DNS Server	
Network Integrity Check	Select this check box to validate that the upstream link is active before allowing wireless associations. Ensure that the default gateway is configured.

3. Click **Apply** button.

Your settings are saved.

Configure the Basic Wireless Settings

For proper compliance and compatibility between similar products in your coverage area, you must configure the 802.11bg/ng/bgn and 802.11a/a-na-ac wireless adapter settings correctly, including the operating channel and country. You also must configure the basic wireless

network settings for wireless devices to connect to your network. For other wireless features, including wireless security, see [Chapter 3, Wireless Configuration and Security](#).



WARNING:

If you configure the wireless access point from a wireless computer and you change the wireless access point's SSID, channel, or wireless security settings, you lose your wireless connection when you click Apply. You then must change the wireless settings of your computer to match the wireless access point's new settings.

Configure 802.11bg/ng/bgn Wireless Settings

➤ To configure the 802.11bg/ng/bgn wireless settings:

1. Select **Configuration > Wireless > Basic > Wireless Settings**.

2. Select the wireless mode in the 2.4 GHz:

- **11bg**. 802.11b-compliant devices and 802.11g-compliant devices can connect to the access point.
- **11ng**. 802.11n-compliant devices and 802.11g-compliant devices can connect to the access point
- **11bgn**. This is the default setting. 802.11b-compliant devices, 802.11n-compliant devices and 802.11g-compliant devices can connect to the access point. If you keep the default setting, go to [Step 5](#).

When you change the wireless mode, the Turn Radio On check box is automatically cleared, and all fields, buttons, and menus onpage are masked out.

3. Turn on the radio by selecting the **Turn Radio On** check box. A pop-up page displays.

Note: Under normal conditions, you want the radio to be turned on. Turning off the radio disables access through the wireless access point, which can be helpful for configuration, network tuning, or troubleshooting activities.

4. Click **OK** to confirm the change of wireless mode. The change does not take effect until you click the Apply button after you have completed the wireless configuration.
5. Specify the remaining wireless settings as explained the following table:

Setting	Descriptions	
Wireless Network Name (SSID)	Enter a 32-character (maximum) service set identifier (SSID); the characters are case-sensitive. The default is NETGEAR_11ng. The SSID assigned to a wireless device must match the wireless access point's SSID for the wireless device to communicate with the wireless access point. If the SSIDs do not match, you do not get a wireless connection to the wireless access point.	
Broadcast Wireless Network Name (SSID)	Select the Yes radio button to enable the wireless access point to broadcast its SSID, allowing wireless stations with a null (blank) SSID to adopt the wireless access point's SSID. Yes is the default setting. To prevent the SSID from being broadcast, select the No radio button.	
Channel / Frequency	<p>From the menu, select the channel you want to use for your wireless LAN. The wireless channels and frequencies depend on the country and wireless mode. The default setting is Auto.</p> <p>Note: It is not be necessary to change the wireless channel unless you experience interference (indicated by lost connections or slow data transfers). If this happens, you might want to experiment with different channels to see which is the best. For more information, see Operating Frequency Guidelines on page 13.</p> <p>Note: For more information about available channels and frequencies, see Technical Specifications on page 107.</p>	
11ng and 11bgn modes only Note: For most networks, the default settings work fine.	MCS Index / Data Rate	From the menu, select a Modulation and Coding Scheme (MCS) index and transmit data rate for the wireless network. The default setting is Best . For a list of all options that you can select from in 11ng and 11bgn modes, see Factory Default Settings on page 110.
	Channel Width	From the menu, select a channel width. The options are 20 MHz and 40 MHz . The default is 40 MHz .
	Guard Interval	From the menu, select the guard interval to protect transmissions from interference. The default is Auto , or you can select Long - 800 ns . Some legacy devices can operate only with a long guard interval.

Setting	Descriptions	
11bg modes only	Data Rate	From the menu, select the transmit data rate of the wireless network. The default setting is Best . For a list of all options that you can select from in 11bg mode, see <i>Factory Default Settings</i> on page 110.
Output Power	<p>From the menu, select the transmission power of the wireless access point: Full, Half, Quarter, Eighth, Minimum. The default is Full.</p> <p>Note: Increasing the power improves performance, but if two or more wireless access points are operating in the same area and on the same channel, interference can occur.</p> <p>Note: Make sure that you comply with the regulatory requirements for total radio frequency (RF) output power in your country.</p>	

- Click **Apply** button.

Your settings are saved.

Note: For information about how to configure advanced wireless settings, see *Configure Advanced Wireless Settings* on page 76.

Configure 802.11a/a-na-ac Wireless Settings

- To configure the 802.11a/a-na-ac wireless settings:

- Select **Configuration > Wireless > Basic > Wireless Settings**.

NETGEAR

WAC720 ProSAFE Dual Band Wireless AC Access Point

Welcome admin

Configuration Monitoring Maintenance Support

System IP Wireless Security Wireless Bridge Ensemble Captive Portal

Cancel Apply

Basic

Wireless Settings - 802.11 bg/ng/bgn

- Wireless Settings
- Wireless Scheduling
- QoS Settings

Advanced

Wireless Mode: 2.4 GHz Band 11bg 11ng 11bgn

Turn Radio On:

Wireless Network Name (SSID): NETGEAR_11ng

Broadcast Wireless Network Name (SSID): Yes No

Channel / Frequency: Auto

MCS Index / Data Rate: Best

Channel Width: 20 MHz

Guard Interval: Auto

Output Power: Full

Wireless Settings - 802.11 a/a-na-ac

Wireless Mode: 5 GHz Band 11a 11a-na-ac

Turn Radio On:

Wireless Network Name (SSID): NETGEAR_11ac

Broadcast Wireless Network Name (SSID): Yes No

Channel / Frequency: Auto

MCS Index / Data Rate: Best

Channel Width: 80 MHz

Guard Interval: Auto

Output Power: Full

Wireless Settings - AP

Wireless Scheduling Status: Disabled

- Select the wireless mode in the 5 GHz band:
 - 11a.** 802.11n-compliant devices can connect to the access point because they are backward compatible.
 - 11a-na-ac.** This is the default setting. If you keep the default setting, go to [Step 5](#).

When you change the wireless mode, the **Turn Radio On** check box is automatically cleared, and all fields, buttons, and menus on the page are masked out.

- Turn on the radio by selecting the **Turn Radio On** check box.
A pop-up page displays.

Note: Under normal conditions, you want the radio to be turned on. Turning off the radio disables access through the wireless access point, which can be helpful for configuration, network tuning, or troubleshooting activities.

- Click **OK** to confirm the change of wireless mode.

The change does not take effect until you click the **Apply** button after you have completed the wireless configuration.

5. Specify the remaining wireless settings as explained the following table:

Setting	Descriptions	
Wireless Network Name (SSID)	Enter a 32-character (maximum) service set identifier (SSID); the characters are case-sensitive. The default is NETGEAR_11ac. The SSID assigned to a wireless device needs to match the wireless access point's SSID for the wireless device to communicate with the wireless access point. If the SSIDs do not match, you do not get a wireless connection to the wireless access point.	
Broadcast Wireless Network Name (SSID)	Select the Yes radio button to enable the wireless access point to broadcast its SSID, allowing wireless stations with a null (blank) SSID to adopt the wireless access point's SSID. Yes is the default setting. To prevent the SSID from being broadcast, select the No radio button.	
Channel / Frequency	<p>From the menu, select the channel you wish to use on your wireless LAN. The wireless channels and frequencies depend on the country and wireless mode. The default setting is Auto.</p> <p>Note: It should not be necessary to change the wireless channel unless you experience interference (indicated by lost connections or slow data transfers). If this happens, you might want to experiment with different channels to see which is the best. For more information, see the guidelines following this table.</p> <p>Note: For more information about available channels and frequencies, see <i>Technical Specifications</i> on page 107.</p>	
11a-na-ac mode only Note: For most networks, the default settings work fine.	MCS Index / Data Rate	From the menu, select a Modulation and Coding Scheme (MCS) index and transmit data rate for the wireless network. The default setting is Best . For a list of all options that you can select from in 11a-na-ac mode, see <i>Factory Default Settings</i> on page 110.
	Channel Width	From the menu, select a channel width. The options are 20 MHz, 40 MHz, and 80 MHz . The default is 80 MHz .
	Guard Interval	From the menu, select the guard interval to protect transmissions from interference. The default is Auto , or you can select Long - 800 ns . Some legacy devices can operate only with a long guard interval.
11a mode only	Data Rate	From the menu, select the transmit data rate of the wireless network. The default setting is Best. For a list of all options that you can select from in 11a mode, see <i>Factory Default Settings</i> on page 110.
Output Power	<p>From the menu, select the transmission power of the wireless access point: Full, Half, Quarter, Eighth, Minimum. The default is Full.</p> <p>Note: Increasing the power improves performance, but if two or more wireless access points are operating in the same area and on the same channel, interference can occur.</p> <p>Note: Make sure that you comply with the regulatory requirements for total radio frequency (RF) output power in your country.</p>	

6. Click **Apply** button.

Your settings are saved.

Note: For information about how to configure advanced wireless settings, see [Configure Advanced Wireless Settings](#) on page 76.

Test Basic Wireless Connectivity

After you have configured the wireless access point, test the computers on your LAN for wireless connectivity before you position and mount the wireless access point at its permanent position.

➤ **To test for wireless connectivity:**

1. Configure the wireless adapters of your computers so that they all use the same SSID and channel that you configured on the wireless access point.
2. Verify that your computers acquired a wireless link to the wireless access point.
3. Verify network connectivity by using a browser such as Internet Explorer 6.0 or later or Mozilla Firefox 1.5 or later to browse the Internet, or check for file and printer access on your network.

Note: If you experience trouble connecting to the wireless access point, see [Chapter 6, Troubleshooting](#).

We recommend that you complete the following tasks before you deploy the wireless access point in your network:

- Configure wireless security and other wireless features as described in [Chapter 3, Wireless Configuration and Security](#).
- Configure any additional features that you might need as described in [Chapter 4, Management and Monitoring](#), and [Chapter 5, Advanced Configuration](#).

After you complete the configuration of the wireless access point, you can reconfigure the computer that you used for this process back to its original TCP/IP settings.

Mount the Wireless Access Point

The following sections explain how to mount your wireless access point. We recommend that you review the information in [Wireless Equipment Placement and Range Guidelines](#) on page 11 before you mount the wireless access point at its permanent position.

- [Ceiling Installation](#)
- [Wall Installation](#)

Ceiling Installation

The best location for ceiling installation is at the center of your wireless coverage area, and within line of sight of all mobile devices. Make sure that the top (the dome side) of the wireless access point is directed toward the users and not the ceiling.

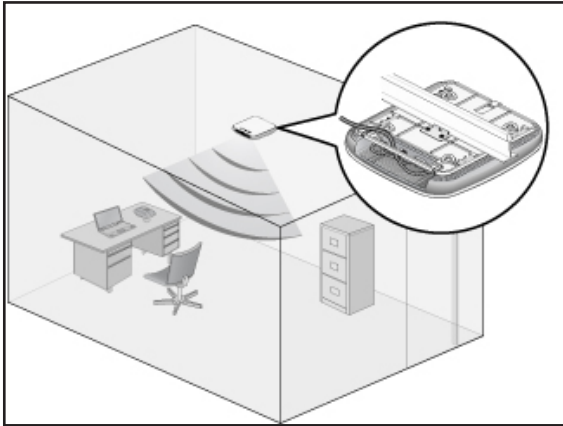

Note: Do not place the wireless access point in a false ceiling space facing up.

➤ **To install the wireless access point using the ceiling installation kit:**

1. Verify the package contents of the ceiling installation kit.

Mounting plate with screws

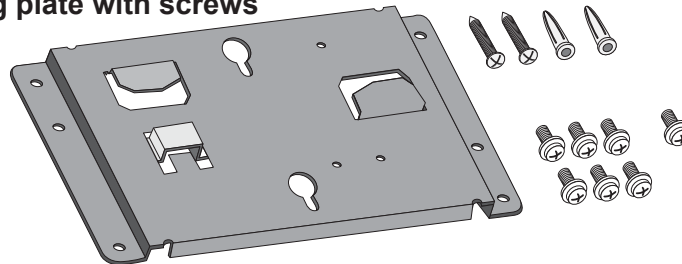

2. Attach the mounting bracket to the access point using the six mounting screws.

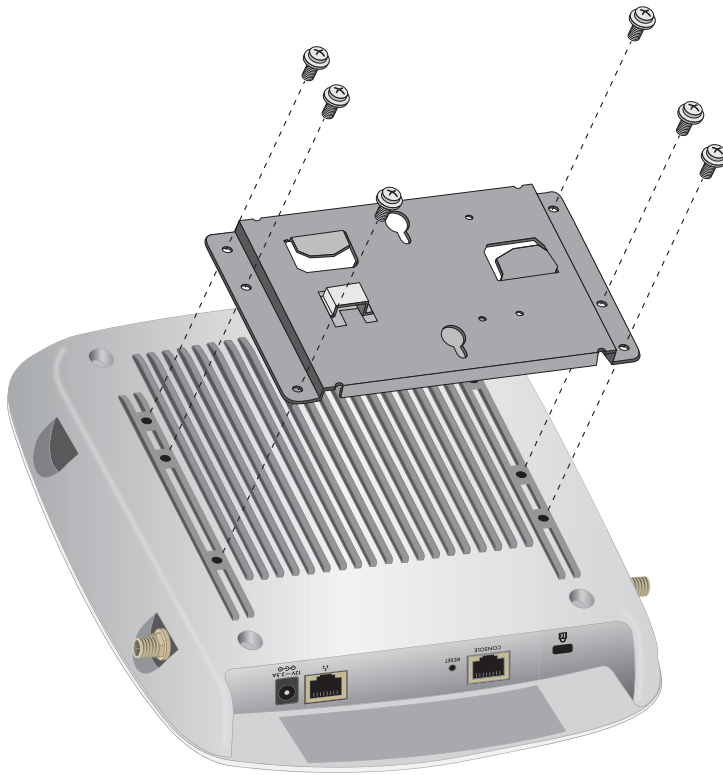

3. Attach the mounting plate to the ceiling rail.

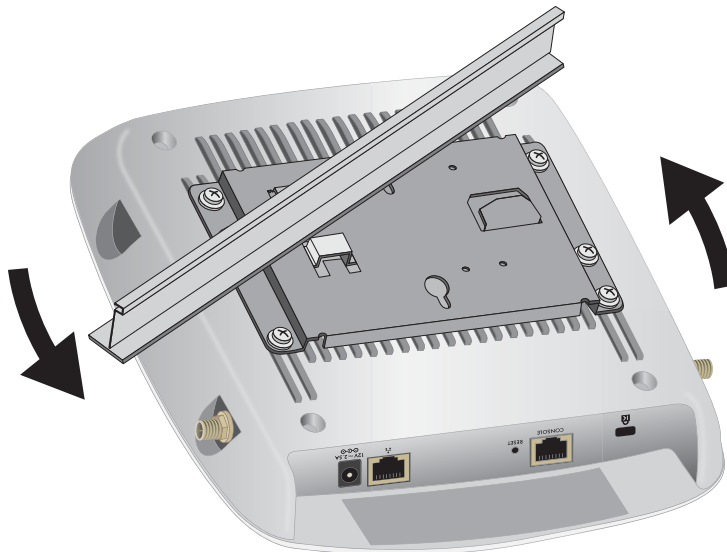

4. Secure the mounting plate with the included screws.

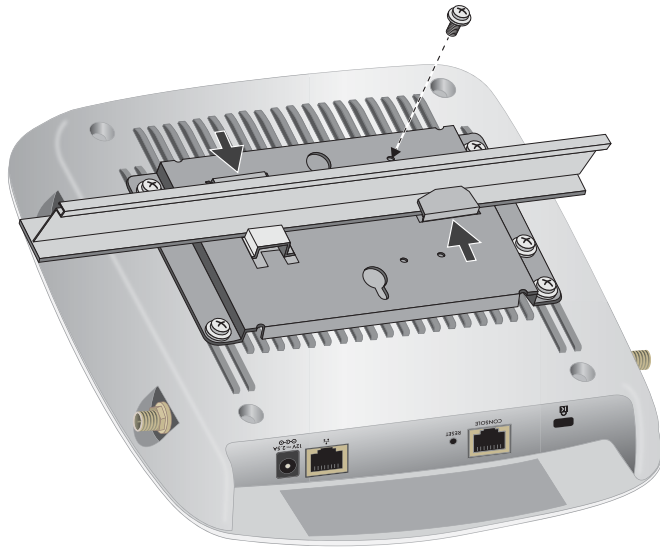

Wall Installation

The best location for wall installation is at the center of your wireless coverage area, and within line of sight of all mobile devices. Make sure that the top (the dome side) of the wireless access point is directed toward the users and not the wall.

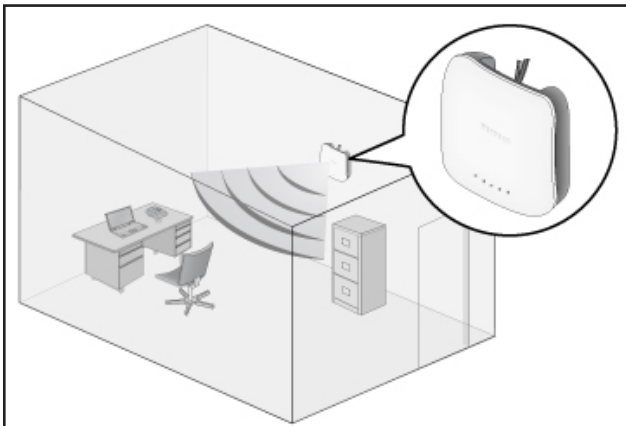

➤ **To install the wireless access point using the wall installation kit:**

1. Place the mounting bracket on the wall where you want to mount the access point.
2. Mark the wall where the two mounting holes are.
3. Attach the mounting bracket to the access point using the six mounting screws as shown.

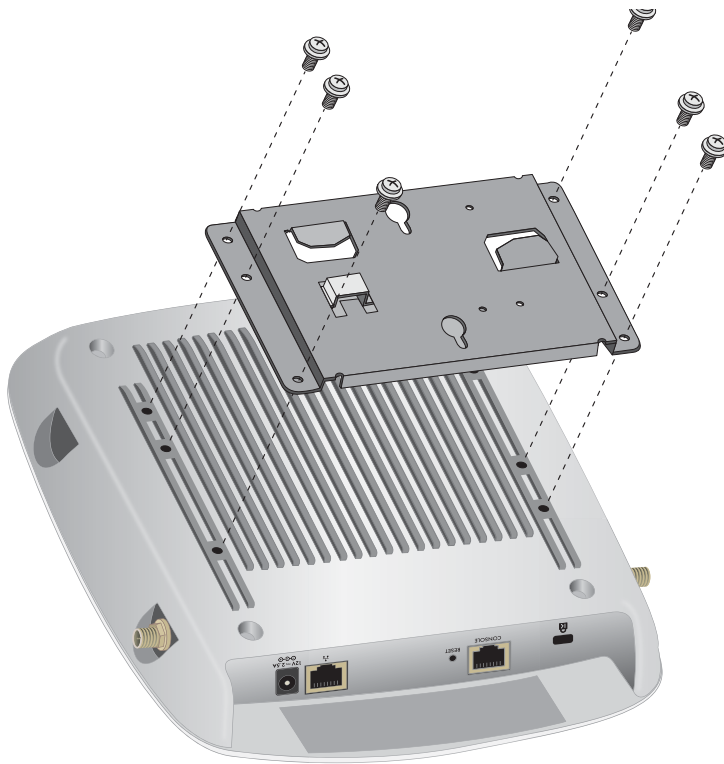

4. Attach the wall anchors and screws to the wall where you previously marked. Leave a space 1/8 of an inch (3.5 mm) wide between the heads of the screws and the wall.

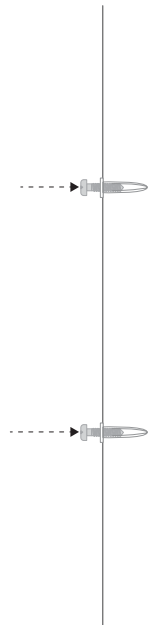

5. Hang the access point on the screws by inserting the screws into the larger portion of the slot and sliding the unit down.

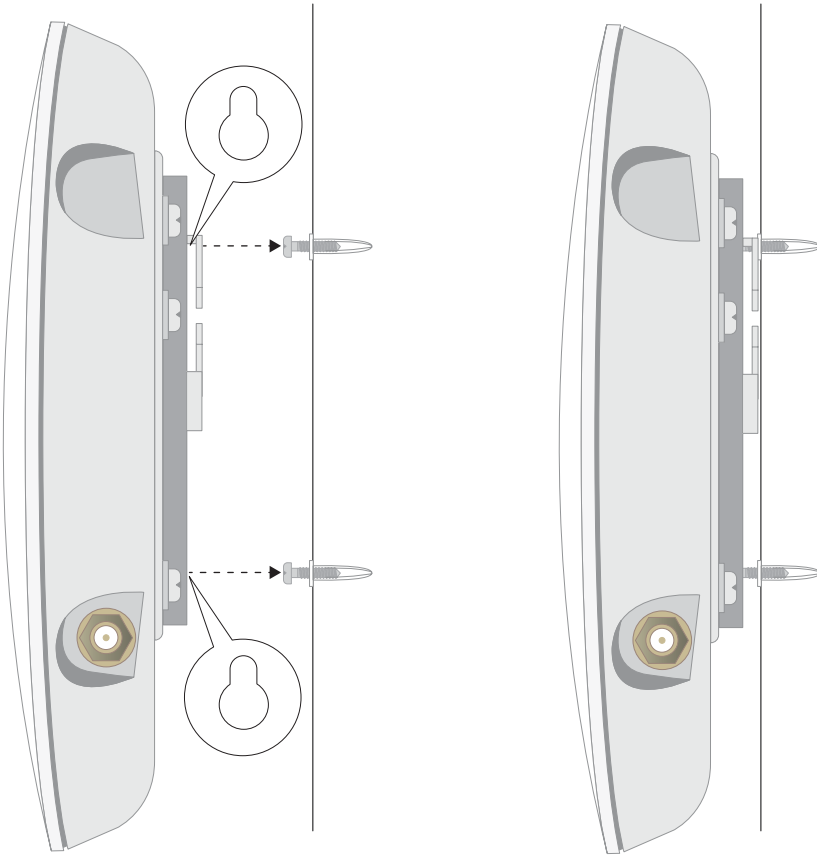

Wireless Configuration and Security

3

This chapter describes how to configure the wireless features of the wireless access point. The chapter includes the following sections:

- *Wireless Data Security Options*
- *Security Profiles*
- *Configure RADIUS Server Settings*
- *Restrict Wireless Access by MAC Address*
- *Enable Rogue AP Detection*
- *Schedule the Wireless Radios to Be Turned Off*
- *Configure Basic Wireless Quality of Service*

Before you set up wireless security and additional wireless features that are described in this chapter, connect the wireless access point, get the Internet connection working, and configure the 802.11bg/ng/bgn and 802.11a/a-na-ac wireless settings as described in [Chapter 2, Initial Setup](#). The wireless access point functions with an Ethernet LAN connection. Make sure that you verify wireless connectivity before you set up wireless security and additional wireless features.



WARNING:

If you are configuring the wireless access point from a wireless computer and you change the wireless access point's SSID, channel, or wireless security settings, you lose your wireless connection when you click the Apply button. You must then change the wireless settings of your computer to match the wireless access point's new settings.

Wireless Data Security Options

Indoors, computers can connect over 802.11ac wireless networks at a maximum range of 300 feet. Typically, a wireless access point inside a building works best with devices within a

100-foot radius. Such distances can allow for others outside your immediate area to access your network.

Unlike wired network data, your wireless data transmissions can extend beyond your walls and can be received by anyone with a compatible adapter. For this reason, use the security features of your wireless equipment. The wireless access point provides highly effective security features that are covered in detail in this chapter. Deploy the security features appropriate to your needs.

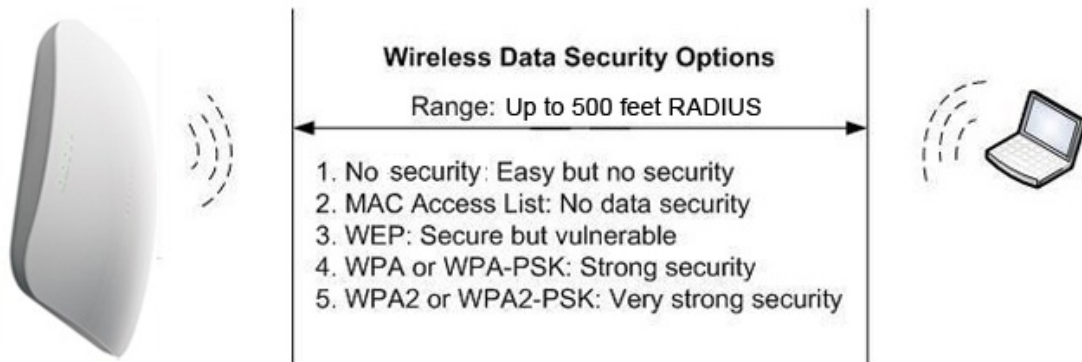

Figure 4.

You can enhance the security of your wireless network in several ways:

- **Use multiple BSSIDs combined with VLANs.** You can configure combinations of VLANs and BSSIDs (security profiles) with stronger or less restrictive access security according to your requirements. For example, visitors could be given wireless Internet access but be excluded from any access to your internal network. For information about how to configure BSSIDs, see [Configure and Enable Security Profiles](#) on page 35.
- **Restrict access based on MAC address.** You can allow only trusted devices to connect so that unknown devices cannot wirelessly connect to the wireless access point. Restricting access by MAC address adds an obstacle against unwanted access to your network, but the data broadcast over the wireless link is fully exposed. For information about how to restrict access by MAC address, see [Restrict Wireless Access by MAC Address](#) on page 44.
- **Turn off the broadcast of the wireless network name (SSID).** If you disable broadcast of the SSID, only devices with the correct SSID can connect. This nullifies the wireless network discovery feature of some products, such as Windows XP, but the data is still exposed. For information about how to turn off broadcast of the SSID, see [Configure and Enable Security Profiles](#) on page 35.
- **Legacy 802.1X.** Legacy 802.1X uses RADIUS-based 802.1x authentication but no data encryption. For information about how to configure Legacy 802.1X, see [Configure and Enable Security Profiles](#) on page 35 and [Configure Legacy 802.1X](#) on page 39.
- **WPA and WPA-PSK (TKIP).** Wi-Fi Protected Access (WPA) data encryption provides strong data security with Temporal Key Integrity Protocol (TKIP) encryption. The very strong authentication along with dynamic per-frame rekeying of WPA makes it virtually impossible to compromise.

WPA uses RADIUS-based 802.1x authentication. For more information, see [Configure and Enable Security Profiles](#) on page 35 and [Configure WPA With RADIUS and WPA & WPA2 With RADIUS](#) on page 40.

WPA-PSK uses a pre-shared key (PSK) for authentication. For more information, see [Configure and Enable Security Profiles](#) on page 35 and [Configure WPA-PSK, WPA2-PSK, and WPA-PSK & WPA2-PSK](#) on page 40.

- **WPA2 and WPA2-PSK (AES).** Wi-Fi Protected Access version 2 (WPA2) data encryption provides strong data security with Advanced Encryption Standard (AES) encryption. The very strong authentication along with dynamic per-frame rekeying of WPA2 makes it virtually impossible to compromise.

WPA2 uses RADIUS-based 802.1x authentication. For more information, see [Configure and Enable Security Profiles](#) on page 35 and [Configure WPA With RADIUS and WPA & WPA2 With RADIUS](#) on page 40.

WPA2-PSK uses a pre-shared key (PSK) for authentication. For more information, see [Configure and Enable Security Profiles](#) on page 35 and [Configure WPA-PSK, WPA2-PSK, and WPA-PSK & WPA2-PSK](#) on page 40.

- **WPA & WPA2 and WPA-PSK & WPA2-PSK mixed modes.** These modes support data encryption either with both WPA and WPA2 clients or with both WPA-PSK and WPA2-PSK clients and provide the most reliable security.

WPA & WPA2 uses RADIUS-based 802.1x authentication. For more information, see [Configure and Enable Security Profiles](#) on page 35 and [Configure WPA With RADIUS and WPA & WPA2 With RADIUS](#) on page 40.

WPA-PSK & WPA2-PSK uses a pre-shared key (PSK) for authentication; for more information, see [Configure and Enable Security Profiles](#) on page 35 and [Configure WPA-PSK, WPA2-PSK, and WPA-PSK & WPA2-PSK](#) on page 40.

Security Profiles

Security profiles let you configure unique security settings for each SSID on each radio of the wireless access point. For each radio, the wireless access point supports up to eight security profiles (BSSIDs) that you can configure on the individual Edit Wireless Network pages that are accessible from the Edit Security Profile page (see [Configure and Enable Security Profiles](#) on page 35).

To set up a security profile, select its network authentication type, data encryption, wireless client security separation, and VLAN ID:

- **Network authentication**
The wireless access point is set by default as an open system with no authentication. When you configure network authentication, bear in mind that not all wireless adapters support WPA or WPA2. Windows XP, Windows 2000 with Service Pack 3, and Windows Vista do include the client software that supports WPA. However, client software is required on the client. Consult the product documentation for your wireless adapter and WPA or WPA2 client software for instructions about how to configure WPA2 settings.

For information about the types of network authentication that the wireless access point supports, see *Configure and Enable Security Profiles* on page 35.

- **Data encryption**
Select the data encryption that you want to use. The available options depend on the network authentication setting (otherwise, the default is None). The data encryption settings are explained in *Configure and Enable Security Profiles* on page 35.
- **Wireless client security separation**
If this feature is enabled, the associated wireless clients (using the same SSID) are not able to communicate with each other. This feature is useful for hotspots and other public access situations. By default, wireless client separation is disabled. For more information, see *Configure and Enable Security Profiles* on page 35.
- **VLAN ID**
If this feature is enabled and if the network devices (hubs and switches) on your LAN support the VLAN (802.1Q) standard, the default VLAN ID for the wireless access point is associated with each profile. The default VLAN ID needs to match the IDs that are used by the other network devices. For more information, see *Configure and Enable Security Profiles* on page 35.

Some concepts and guidelines regarding the SSID are explained in the following list:

- A basic service set (BSS) is a group of wireless stations and a single wireless access point, all using the same security profile or service set identifier (BSSID). The actual identifier in the BSSID is the MAC address of the wireless radio. (A wireless radio can be assigned multiple MAC addresses, one for each security profile.)
- An extended service set (ESS) is a group of wireless stations and multiple wireless access points, all using the same identifier (ESSID).
- Different wireless access points within an ESS can use different channels. To reduce interference, specify that adjacent wireless access points use different channels.
- Roaming is the ability of wireless stations to connect wirelessly when they physically move from one BSS to another one within the same ESS. The wireless station automatically changes to the wireless access point with the least interference or best performance.

Configure and Enable Security Profiles

To configure and enable a security profile, you must enable the associated radio:

- For 802.11bg/ng/bgn modes, the 2.4 GHz radio needs to be enabled (see [Configure 802.11bg/ng/bgn Wireless Settings](#) on page 20).
- For 802.11a/a-na-ac modes, the 5 GHz radio needs to be enabled. (see [Configure 802.11a/a-na-ac Wireless Settings](#) on page 22).

Both radios can function concurrently.

➤ **To configure and enable a security profile:**

1. Select **Configuration > Security > Profile Settings**.

The Profile Settings page for the 802.11bg/ng/bgn and 802.11a/a-na-ac modes shows eight wireless security profiles for each mode. (If the 2.4 GHz radio is disabled, the Enable column is masked out.)

The screenshot shows the NETGEAR web interface for a WAC720 ProSAFE Dual Band Wireless AC Access Point. The user is logged in as 'admin'. The navigation menu includes Configuration, Monitoring, Maintenance, and Support. The 'Configuration' menu is expanded to show System, IP, Wireless, Security, Wireless Bridge, Ensemble, and Captive Portal. The 'Security' menu is selected, and the 'Profile Settings' page is displayed. The page shows two tables of profile settings: one for 802.11bg/ng/bgn and one for 802.11a/a-na-ac. Each table has columns for Profile Name, SSID, Security, VLAN, Enable, and WMF-Enable. The 'Enable' column is checked for profile 0 in both tables.

#	Profile Name	SSID	Security	VLAN	Enable	WMF-Enable
0	NETGEAR	NETGEAR_11ng	Open System	1	<input checked="" type="checkbox"/>	<input type="checkbox"/>
1	NETGEAR-1	NETGEAR_11ng-1	Open System	1	<input type="checkbox"/>	<input type="checkbox"/>
2	NETGEAR-2	NETGEAR_11ng-2	Open System	1	<input type="checkbox"/>	<input type="checkbox"/>
3	NETGEAR-3	NETGEAR_11ng-3	Open System	1	<input type="checkbox"/>	<input type="checkbox"/>
4	NETGEAR-4	NETGEAR_11ng-4	Open System	1	<input type="checkbox"/>	<input type="checkbox"/>
5	NETGEAR-5	NETGEAR_11ng-5	Open System	1	<input type="checkbox"/>	<input type="checkbox"/>
6	NETGEAR-6	NETGEAR_11ng-6	Open System	1	<input type="checkbox"/>	<input type="checkbox"/>
7	NETGEAR-7	NETGEAR_11ng-7	Open System	1	<input type="checkbox"/>	<input type="checkbox"/>

#	Profile Name	SSID	Security	VLAN	Enable	WMF-Enable
0	NETGEAR	NETGEAR_11ac	Open System	1	<input checked="" type="checkbox"/>	<input type="checkbox"/>
1	NETGEAR-1	NETGEAR_11ac-1	Open System	1	<input type="checkbox"/>	<input type="checkbox"/>
2	NETGEAR-2	NETGEAR_11ac-2	Open System	1	<input type="checkbox"/>	<input type="checkbox"/>
3	NETGEAR-3	NETGEAR_11ac-3	Open System	1	<input type="checkbox"/>	<input type="checkbox"/>
4	NETGEAR-4	NETGEAR_11ac-4	Open System	1	<input type="checkbox"/>	<input type="checkbox"/>
5	NETGEAR-5	NETGEAR_11ac-5	Open System	1	<input type="checkbox"/>	<input type="checkbox"/>
6	NETGEAR-6	NETGEAR_11ac-6	Open System	1	<input type="checkbox"/>	<input type="checkbox"/>
7	NETGEAR-7	NETGEAR_11ac-7	Open System	1	<input type="checkbox"/>	<input type="checkbox"/>

The following table explains the fields of the Profile Settings page:

Setting	Description
Profile Name	The unique name of the wireless security profile that makes it easy to recognize the profile.
SSID	The wireless network name (SSID) for the wireless security profile.
Security	The configured wireless authentication method for the wireless security profile.

Setting	Description
VLAN	The default VLAN ID that is associated with the wireless security profile.
WMF Enable	The check box that lets you select the wireless security profile so that you can enable it by clicking the Apply button.

- To configure a wireless security profile, select the corresponding radio button to the left of the wireless security profile.

The Edit Security Profile page contains three sections:

- Profile Definition (see [Step 3](#))
- Authentication Settings (see [Step 4](#))
- QoS Policies (see [Step 5](#))

NETGEAR
WAC720 ProSAFE Dual Band Wireless AC Access Point

Welcome admin

Configuration | Monitoring | Maintenance | Support

System | IP | Wireless | Security | Wireless Bridge | Ensemble | Captive Portal

Back | Cancel | Apply

Profile Settings | Edit Security Profile

Advanced

Profile Definition

Profile Name: NETGEAR

Wireless Network Name (SSID): NETGEAR_11ng

Broadcast Wireless Network Name (SSID): Yes No

Band Steering to 5GHz: Enable Disable

Rssi Threshold 5GHz(-100 to -10): -70

Authentication Settings

Network Authentication: Open System

Data Encryption: None

VLAN ID: 1

QoS Policies

Mode:

Apply Policy: Incoming: Outgoing:

Policy Details: Incoming: None Outgoing: None

Bandwidth Limit (bits per second): Incoming: 0 Outgoing: 0

Captive Portal

Profile Name: None

3. Specify the settings of the Profile Definition section as explained in the following table:

Setting	Description
Profile Name	Enter a unique name of the wireless security profile that makes it easy to recognize the profile. The default names are NETGEAR, NETGEAR-1, NETGEAR-2, and so on, through NETGEAR-7. You can enter a value of up to 32 alphanumeric characters.
Wireless Network Name (SSID)	The wireless network name (SSID) for the wireless security profile. The default names depend on the selected radio band: <ul style="list-style-type: none"> • 802.11bg/ng/bgn. The default names are NETGEAR_11ng, NETGEAR_11ng-1, NETGEAR_11ng-2, and so on, through NETGEAR_11ng-7 for the eighth profile. • 802.11a/na. The default names are NETGEAR_11ac, NETGEAR_11ac-1, NETGEAR_11ac-2, and so on, through NETGEAR_11ac-7 for the eighth profile.
Broadcast Wireless Network Name (SSID)	Select the Yes radio button to enable the wireless access point to broadcast its SSID, allowing wireless stations with a null (blank) SSID to adopt the wireless access point's SSID. Yes is the default setting. To prevent the SSID from being broadcast, select the No radio button.

4. Specify the settings of the Authentication Settings section as explained in the following table.

The wireless access point is set by default as an open system with no authentication. When you configure network authentication, bear in mind the following:

- If you are using access point mode (which is the default mode if you did not enable wireless bridging), then all options are available. In other modes such as bridge mode, some options might be unavailable.
- Not all wireless adapters support WPA or WPA2. Windows XP, Windows 2000 with Service Pack 3, and Windows Vista do include the client software that supports WPA. However, client software is required on the client. Consult the product documentation

for your wireless adapter and WPA or WPA2 client software for instructions about how to configure WPA2 settings.

Setting	Description	
Network Authentication and Data Encryption Note: The data encryption fields that display onpage depend on your selection from the Network Authentication menu.	Open System	This is the default setting. Use an open system without any encryption. See Configure Legacy 802.1X on page 39.
	Legacy 802.1X	Configure the RADIUS server settings. Encryption is not supported. See Configure Legacy 802.1X on page 39.
	WPA with RADIUS	Configure the RADIUS server settings and select TKIP or TKIP + AES encryption. See Configure WPA With RADIUS and WPA & WPA2 With RADIUS on page 40.
	WPA2 with RADIUS	Configure the RADIUS server settings and select AES or TKIP + AES encryption. See Configure WPA With RADIUS and WPA & WPA2 With RADIUS on page 40. Note: Select this setting only if all clients support WPA2.
	WPA & WPA2 with RADIUS	Configure the RADIUS server setting. TKIP + AES encryption is the default encryption. See Configure WPA With RADIUS and WPA & WPA2 With RADIUS on page 40. Note: This setting allows clients to connect through either WPA with TKIP or WPA2 with AES.
	WPA-PSK	Enter a WPA passphrase and select TKIP or TKIP + AES encryption. See Configure WPA-PSK, WPA2-PSK, and WPA-PSK & WPA2-PSK on page 40.
	WPA2-PSK	Enter a WPA passphrase and select AES or TKIP + AES encryption. See Configure WPA-PSK, WPA2-PSK, and WPA-PSK & WPA2-PSK on page 40. Note: Select this setting only if all clients support WPA2.
	WPA-PSK & WPA2-PSK	Enter a WPA passphrase. TKIP + AES encryption is the default encryption. See Configure WPA-PSK, WPA2-PSK, and WPA-PSK & WPA2-PSK on page 40. Note: This setting allows clients to connect through either WPA with TKIP or WPA2 with AES.

Setting	Description
Wireless Client Security Separation	If you enable wireless client security separation by selecting Enable from the menu, the associated wireless clients cannot communicate with each other. By default, Disable is selected from the menu. This feature is intended for hotspots and other public access situations.
VLAN ID	Enter the VLAN ID to be associated with this wireless security profile. The default VLAN ID is 1. The VLAN ID needs to match the VLAN ID that is used by the other devices in your network.

- (Optional) In the QoS Policies section, select a QoS policy from the **Incoming** menu, **Outgoing** menu, or both. Depending on your selection, the policy is applied to incoming packets, outgoing packets, or both incoming and outgoing packets, and is displayed in the Policy Details fields.

Note: To be able to select a QoS policy, you must first configure one or more policies (see *Configure Quality of Service Policies* on page 81).

- Click the **Apply** button.
Your settings are saved.



WARNING:

If you use a wireless computer to configure wireless security settings, you are disconnected when you click the **Apply** button. Reconfigure your wireless computer to match the new settings, or access the wireless access point from a wired computer to make further changes.

- **To change the QoS policy selection on the Edit Security Profile page:**
 - From the menu from which you want select another QoS policy, select **None**.
 - Click the **Apply** button.
The old policy is removed from the security profile.
 - Select the new QoS policy from the same menu.
 - Click the **Apply** button.
Your settings are saved.

Configure Legacy 802.1X

To use legacy 802.1X security, you must define RADIUS server settings. For information about RADIUS servers, see *Configure RADIUS Server Settings* on page 41.

When you select **Legacy 802.1X** from the **Network Authentication** menu, the **Data Encryption** menu is automatically set to **None**. To use legacy 802.1X security, you must define the RADIUS servers only.

Configure WPA With RADIUS and WPA & WPA2 With RADIUS

WPA and WPA & WPA2 security requires RADIUS-based 802.1x authentication, so you also must define RADIUS server settings. For information about RADIUS servers, see [Configure RADIUS Server Settings](#) on page 41.

The selections that are available from the **Data Encryption** menu depend on the type of WPA authentication that you select from the **Network Authentication** menu and are shown in the following table.

Setting	Descriptions
AES	Advanced Encryption Standard (AES) is the standard encryption method used with WPA2. Note: Although some wireless clients might support AES with WPA, the WAC720 and WAC730 wireless access points do not support WPA with AES.
TKIP + AES	The TKIP + AES encryption method is supported both for WPA and WPA2. Broadcast packets use TKIP. For unicast (point-to-point) transmissions, WPA clients use TKIP, and WPA2 clients use AES. For the WPA & WPA2 mixed mode, TKIP + AES is the only supported data encryption method.

Configure WPA-PSK, WPA2-PSK, and WPA-PSK & WPA2-PSK

WPA-PSK, WPA2-PSK, and WPA-PSK & WPA2-PSK authentication use a pre-shared key (PSK, also called a passphrase or a network key) and do not require authentication from a RADIUS server.

The selections that are available from the **Data Encryption** menu depend on the type of WPA-PSK authentication that you select from the **Network Authentication** menu and are shown in the following table.

Setting	Descriptions	
Data Encryption	AES	Advanced Encryption Standard (AES) is the standard encryption method used with WPA2. Note: Although some wireless clients might support AES with WPA, the WAC720 and WAC730 wireless access points do not support WPA with AES.
	TKIP + AES	TKIP + AES supports both WPA and WPA2. Broadcast packets use TKIP. For unicast (point-to-point) transmissions, WPA clients use TKIP, and WPA2 clients use AES. For the WPA & WPA2 mixed mode, TKIP + AES is the only supported data encryption method.

Setting	Descriptions
Passphrase	Enter a passphrase. The passphrase length needs to be between 8 and 63 characters (inclusive). The default passphrase is sharedsecret. You can display the actual passphrase by selecting the Show Passphrase in Clear Text Yes radio button.
Show Passphrase in Clear Text	Select the Yes radio button to display the actual passphrase in the Passphrase field. The default setting is No .

Configure RADIUS Server Settings

For authentication, accounting, or both authentication and accounting using RADIUS, you must configure primary servers and optional secondary servers. These RADIUS server settings can apply to all devices that are connected to the wireless access point.

You can configure both IPv4 and IPv6 servers. In the IPv4 RADIUS Server Settings section, enter IPv4 addresses only. In the IPv6 RADIUS Server Settings section, enter IPv6 addresses only.

➤ **To configure the RADIUS server settings:**

1. Select **Configuration > Security > Advanced > RADIUS Server Settings**.

The screenshot shows the NETGEAR configuration interface for a WAC720 ProSAFE Dual Band Wireless AC Access Point. The user is logged in as 'admin'. The navigation menu includes Configuration, Monitoring, Maintenance, Support, System, IP, Wireless, Security, Wireless Bridge, Ensemble, and Captive Portal. The 'Security' section is expanded to show 'RADIUS Server Settings'.

RADIUS Server Settings

IPv4 RADIUS Server Settings

	IPv4 Address	Port	Shared Secret
Primary Authentication Server	192.168.1.1	1812	*****
Secondary Authentication Server		1812	
Primary Accounting Server	192.168.1.1	1813	*****
Secondary Accounting Server		1813	

IPv6 RADIUS Server Settings

	IPv6 Address	Port	Shared Secret
Primary Authentication Server	::	1812	*****
Secondary Authentication Server		1812	
Primary Accounting Server	::	1813	*****
Secondary Accounting Server		1813	

Authentication Settings

Reauthentication Time (secs)

Update Global Key Every (secs)

2. Specify the settings as explained in the following table:

Setting	Descriptions	
RADIUS Server Settings		
Primary Authentication Server	IPv4 Address or IPv6 Address	Enter the IP address of the primary RADIUS server for authentication.
	Port	Enter the number of the UDP port on the wireless access point that is used to access the primary RADIUS server for authentication. The default port number is 1812.
	Shared Secret	Enter the shared key that is used between the wireless access point and the primary RADIUS server during authentication.
Secondary Authentication Server	IPv4 Address or IPv6 Address	Enter the IP address of the secondary RADIUS server for authentication. The secondary RADIUS server is used when the primary RADIUS server is not available.
	Port	Enter the number of the UDP port on the wireless access point that is used to access the secondary RADIUS server for authentication. The default port number is 1812.
	Shared Secret	Enter the shared key that is used between the wireless access point and the secondary RADIUS server during authentication.
Primary Accounting Server	IPv4 Address or IPv6 Address	Enter the IP address of the primary RADIUS server for accounting.
	Port	Enter the number of the UDP port on the wireless access point that is used to access the primary RADIUS server for accounting. The default port number is 1813.
	Shared Secret	Enter the shared key that is used between the wireless access point and the primary RADIUS server during the accounting process.
Secondary Accounting Server	IPv4 Address or IPv6 Address	Enter the IP address of the secondary RADIUS server for accounting. The secondary RADIUS server is used when the primary RADIUS server is not available.
	Port	Enter the number of the UDP port on the wireless access point that is used to access the secondary RADIUS server for accounting. The default port number is 1813.
	Shared Secret	Enter the shared key that is used between the wireless access point and the secondary RADIUS server during the accounting process.
Authentication Settings		
Reauthentication Time (Seconds)	The interval in seconds after which the supplicant is reauthenticated with the RADIUS server. The default interval is 3600 seconds (1 hour). Enter 0 to disable reauthentication.	
Update Global Key Every (Seconds)	Select the check box to allow the global key update, and enter the interval in seconds. The check box is selected by default, and the default interval is 1800 seconds (30 minutes). Clear the check box to prevent the global key update.	

3. Click the **Apply** button.
Your settings are saved.

Restrict Wireless Access by MAC Address

For increased security, you can restrict access to an SSID by allowing access to only specific computers or wireless stations based on their MAC addresses. You can restrict access to only trusted computers so that unknown computers cannot connect wirelessly to the wireless access point. MAC address filtering adds an obstacle against unwanted access to your network, but the data broadcast over the wireless link is fully exposed.

Note: For wireless adapters, you can usually find the MAC address printed on the wireless adapter.

➤ **To restrict access based on MAC addresses:**

1. Select **Configuration > Security > Advanced > MAC Authentication**.

The screenshot shows the NETGEAR configuration interface for a WAC720 ProSAFE Dual Band Wireless AC Access Point. The user is logged in as 'admin'. The navigation menu includes Configuration, Monitoring, Maintenance, Support, System, IP, Wireless, Security, Wireless Bridge, Ensemble, and Captive Portal. The 'Security' section is expanded to show 'MAC Authentication'. The 'Trusted MAC List' section has options to 'Import MAC Address List from a file' (with 'Replace' and 'Merge' radio buttons and a 'Choose File' button) and buttons for 'Add', 'Delete', and 'Download Sample'. Below this is a table for 'Trusted Wireless Stations' with a 'MAC Address' column. The 'MAC Authentication - 802.11 bg/ng/bgn' section has a 'Turn Access Control On' checkbox (checked) and a 'Select Access Control Database' dropdown menu set to 'Local MAC Address Database', with a 'Move' button. Below that is a table for 'Available Wireless Stations' with 'Station ID' and 'MAC Address' columns. The 'MAC Authentication - 802.11 a/a-na-ac' section also has a 'Turn Access Control On' checkbox (checked) and a 'Select Access Control Database' dropdown menu set to 'Local MAC Address Database', with a 'Move' button. Below that is another table for 'Available Wireless Stations' with 'Station ID' and 'MAC Address' columns.

2. Select the **Turn Access Control On** check box to enable the access control feature.
3. From the **Select Access Control Database** menu, select a database option:
 - **Local MAC Address Database.** The wireless access point uses the local MAC address database for access control. This is the default setting.
 - **Remote MAC Address Database.** The wireless access point uses the MAC address database on an external RADIUS server on the LAN for access control. If you select this database, you first must configure the RADIUS server settings (see [Configure RADIUS Server Settings](#) on page 41).
4. Click the **Refresh** button to refresh the Available Wireless Stations table.

The wireless access point places the MAC addresses of the attached wireless stations in this table.

5. Populate the Trusted Wireless Stations table by one of the following methods:
 - Select MAC addresses from the Available Wireless Stations table:
 - a. Select individual check boxes for MAC addresses, or select all MAC addresses by selecting the check box in the heading.
 - b. Click the **Move** button to transfer the MAC addresses from the Available Wireless Stations table to the Trusted Wireless Stations table.
 - Enter MAC addresses manually:
 - a. Enter a MAC address directly in the Trusted Wireless Stations table.
 - b. Click the **Add** button.

To delete a MAC address from the Trusted Wireless Stations table, select individual check boxes for MAC addresses, or select all MAC addresses by selecting the check box in the heading, and then click the **Delete** button.

6. Click the **Apply** button.

Your settings are saved.

Now, only devices in the Trusted Wireless Stations table are allowed to connect to the wireless access point over a wireless connection.



WARNING:

When configuring the wireless access point from a wireless computer whose MAC address is not on the access control list, you lose your wireless connection when you click the Apply button. You then must access the wireless access point from a wired computer or from a wireless computer that is on the access control list to make any further changes.

Enable Rogue AP Detection

Unidentified access points that use the SSID of a legitimate network can present a serious security threat. Detecting rogue access points involves scanning the wireless environment on all available channels, looking for unidentified access points.

When Rouge AP Detection is enabled, the access point will only interact with devices in the Known AP list.

- **To enable Rouge AP detection:**
 1. Select **Configuration > Security > Advanced > Rogue AP**.

2. Select the **Turn Rogue AP Detection On** check box.
3. Select a detection policy from the **Rogue AP Detection Policy** menu:
 - **Mild.** The AP scans for unknown APs every 180 seconds.
 - **Moderate.** The AP scans for unknown APs every 60 seconds.
 - **Aggressive.** The AP scans for unknown APs every 10 seconds.
4. To import a list of known APs, click the **Choose File** button.

The file you import must be a plain-text file with a `.txt` or `.cfg` extension. Entries in the file are MAC addresses in hexadecimal format with each octet separated by colons, for example `00:11:22:33:44:55`. Separate entries with a single space. For the AP to accept the file, it must contain only MAC addresses.

5. Click the **Apply** button.

Your settings are saved.

Schedule the Wireless Radios to Be Turned Off

Scheduling the wireless radios to be turned off is a green feature that allows you to turn off the wireless radios during scheduled vacations, office shutdowns, on evenings, or on weekends.

- **To schedule the radios to be turned on and off:**

1. Select **Configuration > Wireless > Basic > Wireless Scheduling**.

NETGEAR

WAC720 ProSAFE Dual Band Wireless AC Access Point

Welcome admin

Configuration Monitoring Maintenance Support

System IP Wireless Security Wireless Bridge Ensemble Captive Portal

Cancel Apply

Basic

- Wireless Settings
- Wireless Scheduling**
- QoS Settings
- Advanced

Wireless Scheduling

Wireless Scheduling Enable Disable

Radio Off Schedule M T W T F S S

Radio On Time (24-hour) 7 : 00

Radio Off Time (24-hour) 18 : 30

2. Specify the settings as explained in the following table:

Setting	Description
Wireless Scheduling	Select the Enable radio button to enable the timer. By default, the Disable radio button is selected.
Radio Off Schedule	Select check boxes to specify the days when you want to schedule the radios to be turned off. By default, Saturday and Sunday are selected.
Radio On Time	Enter the time that you want the radios to be turned back on. Use 24-hour time format.
Radio Off Time	Enter the time that you want the radios to be turned off. Use 24-hour time format.

3. Click the **Apply** button.

Your settings are saved.

Configure Basic Wireless Quality of Service

Wi-Fi Multimedia (WMM) is a subset of the 802.11e standard. WMM allows you to specify a range of priorities, depending on the type of data. Time-dependent information, such as video or audio, has a higher priority than normal traffic. For WMM to function correctly, wireless clients must also support WMM.

By enabling WMM, you allow Quality of Service (QoS) control for upstream traffic flowing from a wireless station to the wireless access point and for downstream traffic flowing from the wireless access point to a wireless station.

WMM defines the following four queues in decreasing order of priority:

- **Voice.** The highest priority queue with minimum delay, which makes it ideal for applications like VoIP and streaming media.
- **Video.** The second highest priority queue with low delay is given to this queue. Video applications are routed to this queue.
- **Best Effort.** The medium priority queue with medium delay is given to this queue. Most standard IP applications use this queue.

- **Background.** Low priority queue with high throughput. Applications, such as FTP, that are not time-sensitive but require high throughput can use this queue.

The WMM Powersave feature saves power for battery-powered equipment by increasing the efficiency and flexibility of data transmission.

Note: For information about how to configure advanced wireless QoS, that is, to configure specific Enhanced Distributed Channel Access (EDCA) settings, see *Configure Advanced Quality of Service Settings* on page 79.

➤ **To configure basic wireless QoS:**

1. Select **Configuration > Wireless > Basic > QoS Settings**.

The screenshot shows the NETGEAR configuration interface for a WAC720 ProSAFE Dual Band Wireless AC Access Point. The user is logged in as 'admin'. The navigation menu includes Configuration, Monitoring, Maintenance, and Support. The main menu has tabs for System, IP, Wireless, Security, Wireless Bridge, Ensemble, and Captive Portal. The 'QoS Settings' page is displayed, showing a sidebar with 'Basic' and 'Advanced' sections. Under 'Basic', 'QoS Settings' is selected. The main content area shows 'QoS Settings' for two radio bands: 802.11 bg/ng/bgn and 802.11 a/a-na-ac. For each band, there are radio buttons for 'Mode' (Enable/Disable), 'Enable Wi-Fi Multimedia (WMM)', and 'WMM Powersave'.

2. Enable or disable the WMM features:
 - **Enable Wi-Fi Multimedia (WMM).** To enable this feature, select the **Enable** radio button, which is the default setting. Select the **Disable** radio button to disable the feature.
 - **WMM Powersave.** To enable this feature, select the **Enable** radio button, which is the default setting. Select the **Disable** radio button to disable the feature.
3. Click the **Apply** button.

Your settings are saved.

4 Management and Monitoring

4

This chapter describes how to use the management and monitoring features of the wireless access point. The chapter includes the following sections:

- *Enable Remote Management*
- *Upgrade the Wireless Access Point Software*
- *Manage the Configuration File or Reset to Factory Defaults*
- *Change the Administrator Password*
- *Manage User Accounts*
- *Enable the Syslog Server*
- *Monitor the Wireless Access Point*
- *View the Activity Log*
- *Enable and Configure Ensemble Mode*

Enable Remote Management

Both Simple Network Management Protocol (SNMP) and the remote console Secure Shell (SSH) are enabled by default, which allows for remote management of the wireless access point from a client running SNMP management software, as well as from an SSH client. The Telnet console is disabled by default.

- *SNMP Management*
- *Secure Shell and Telnet Management*

SNMP Management

➤ To set up an SNMP management interface:

1. Select **Maintenance > Remote Management > SNMP**.

The screenshot shows the NETGEAR web interface for a WAC720 ProSAFE Dual Band Wireless AC Access Point. The user is logged in as 'admin'. The navigation menu includes Configuration, Monitoring, Maintenance (selected), and Support. Under Maintenance, there are links for Password, Reset, Remote Management (selected), Upgrade, and Ensemble Upgrade. The 'SNMP' configuration page is displayed, showing the following settings:

- SNMP: Enable Disable
- Read-Only Community Name: public
- Read-Write Community Name: private
- Trap Community Name: NETGEAR
- IP Address to Receive Traps: (empty)
- Trap Port: 162

2. Specify the settings as explained in the following table:

Setting	Description
SNMP	Select the Enable radio button to allow the SNMP network management software, such as HP OpenView, to manage the wireless access point through SNMPv1/v2 protocol. By default, the Disable radio button is selected.
Read-Only Community Name	Enter the community string to allow the SNMP manager to read the wireless access point's Management Information Base (MIB) objects. The default is public .
Read-Write Community Name	Enter the community string to allow the SNMP manager to read and write the wireless access point's MIB objects. The default is private .
Trap Community Name	Enter the community string to allow the SNMP manager to send traps. The default is trap .
IP Address to Receive Traps	Enter the IP address of the SNMP manager to receive traps sent from the wireless access point.
Trap Port	Enter the number of the SNMP manager port to receive traps sent from the wireless access point. The default is 162 .

3. Click the **Apply** button.

Your settings are saved.

Secure Shell and Telnet Management

➤ To configure remote console features:

1. Select **Maintenance > Remote Management > Remote Console**.

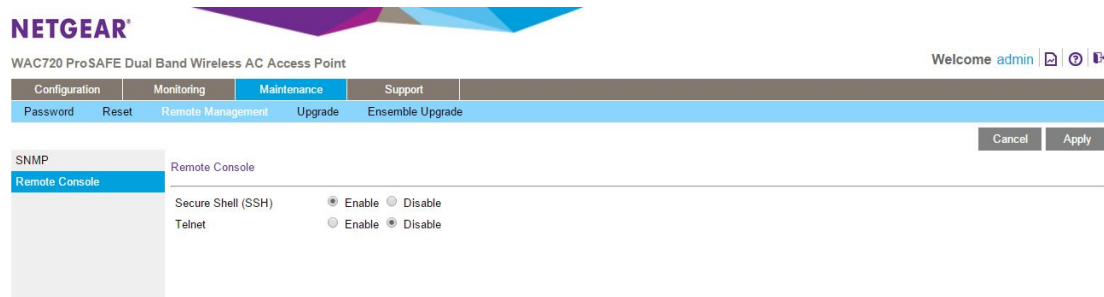

2. Enable or disable the remote console features:
 - **Secure Shell (SSH)**. To enable this feature, select the **Enable** radio button, which is the default setting. Select the **Disable** button to disable the feature.
 - **Telnet**. To enable this feature, select the **Enable** radio button. Select the **Disable** button to disable the feature, which is the default setting.
3. Click the **Apply** button.

Your settings are saved.

➤ To manage the wireless access point over a Telnet connection:

1. Connect an Ethernet cable to the console port of the wireless access point.
2. Connect the other end of the cable to a VT100/ANSI terminal or a workstation.

If you attach a PC, Apple Macintosh, or UNIX workstation, start a secure terminal emulation program, and configure the terminal emulation program to use the following settings:

- **Baud rate.** 9600 bps
 - **Data bits.** 8
 - **Parity.** none
 - **Stop bit.** 1
 - **Flow control.** none
3. Start a secure Telnet session from the terminal or workstation to the wireless access point. A page similar to the following displays:

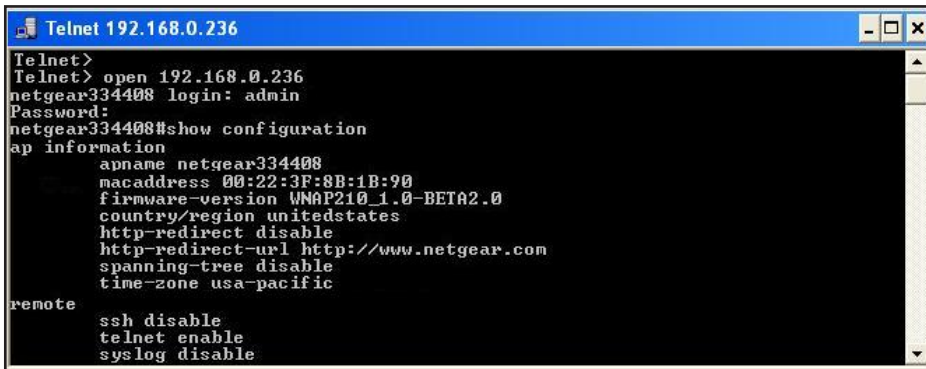

```

Telnet 192.168.0.236
Telnet>
Telnet> open 192.168.0.236
netgear334408 login: admin
Password:
netgear334408#show configuration
ap information
  apname netgear334408
  macaddress 00:22:3F:8B:1B:90
  firmware-version WNAP210_1.0-BETA2.0
  country/region unitedstates
  http-redirect disable
  http-redirect-url http://www.netgear.com
  spanning-tree disable
  time-zone usa-pacific

remote
  ssh disable
  telnet enable
  syslog disable

```

4. Enter the login name and password.

The default login name is **admin** and the default password is **password**.

After successful login, the > prompt appears, preceded by the name of the wireless access point. In this example, the prompt is `netgear334408`.

5. Enter the CLI commands that you want to use.

You can enter **show configuration** to display the available CLI commands. The CLI commands are also listed in [Appendix B, Command-Line Reference](#).

Note: You can also access the wireless access point remotely over a Telnet or SSH session using an application such as PuTTY, if such an encryption application is allowed by law in your country. After you connect to the wireless access point, enter the login name and password to access the CLI.

Upgrade the Wireless Access Point Software

The software of the wireless access point is stored in flash memory and can be upgraded as NETGEAR releases new software. You can download upgrade files from the NETGEAR website. If the upgrade file is compressed (.zip file), you first must extract the image (.rmt) file before sending it to the wireless access point. You can send the upgrade file using your browser. Two methods are available to perform a software upgrade, which are described in the following sections:

- [Web Browser Upgrade Procedure](#)
- [TFTP Server Upgrade Procedure](#)

Note: The web browser that you use to upload new firmware into the wireless access point needs to support HTTP uploads. Use a browser such as Microsoft Internet Explorer 6.0 or later or Mozilla 1.5 or later.

Note: You cannot perform the software upgrade from a computer that is connected to the wireless access point over a wireless link. You must use a computer that is connected to the wireless access point over an Ethernet cable.



WARNING:

When uploading software to the wireless access point, do *not* interrupt the web browser by closing the window, clicking a link, or loading a new page. If the browser is interrupted, the upload might fail, corrupt the software, and render the wireless access point inoperable.

IMPORTANT:

In some cases, such as a major upgrade, you might need to erase the configuration and manually reconfigure your wireless access point after upgrading it. See the release notes included with the software to find out if you must reconfigure the wireless access point.

Web Browser Upgrade Procedure

- To use a web browser to upgrade the wireless access point firmware:
 1. Download the new software file from the NETGEAR website and save it to your hard disk.
 2. If necessary, unzip the new software file.
 3. If available, read the release notes before upgrading the software.
 4. Select **Maintenance > Upgrade > Firmware Upgrade**.



5. Click the **Browse** button and locate the image (.tar) upgrade file.
6. Click the **Apply** button to initiate the upgrade process.

During the upgrade process, the wireless access point automatically restarts. The upgrade process typically takes several minutes. When the Test LED turns off, wait a few more seconds before doing anything with the wireless access point.

7. Verify that the new software file was installed by selecting **Monitoring > System**.

The System page displays (see *Figure* on page 62). The firmware version is shown in the Access Point Information section of the page.

TFTP Server Upgrade Procedure

To use this method, you must have a TFTP server set up.

- **To use a TFTP server to upgrade the wireless access point firmware:**

1. Download the new software file from the NETGEAR website and save it to your hard disk.
2. Place the software file in your TFTP server location.
3. If available, read the release notes before upgrading the software.
4. Select **Maintenance > Upgrade > Firmware Upgrade TFTP**.

The screenshot shows the NETGEAR web interface for a WAC720 ProSAFE Dual Band Wireless AC Access Point. The user is logged in as 'admin'. The navigation menu includes Configuration, Monitoring, Maintenance, and Support. Under Maintenance, there are sub-menus for Password, Reset, Remote Management, Upgrade, and Ensemble Upgrade. The 'Upgrade' sub-menu is selected, and the 'Firmware Upgrade TFTP' option is highlighted in the left sidebar. The main content area displays the 'Firmware Upgrade TFTP' configuration page, which includes a sidebar with options like 'Firmware Upgrade', 'Firmware Upgrade TFTP', 'Backup Settings', and 'Restore Settings'. The main area has two input fields: 'Firmware File Name' and 'TFTP Server IP'. There are 'Cancel' and 'Apply' buttons at the bottom right.

5. Specify the following information:
 - **Firmware File Name.** The name of the software file.
 - **TFTP Server IP.** The IP address of your TFTP server.
6. Click the **Apply** button to initiate the upgrade process.

During the upgrade process, the wireless access point automatically restarts. The upgrade process typically takes several minutes. When the Test LED turns off, wait a few more seconds before doing anything with the wireless access point.

7. Verify that the new software file has been installed by selecting **Monitoring > System**.

The System page displays (see *Figure* on page 62). The firmware version is shown in the Access Point Information section of the page.

Manage the Configuration File or Reset to Factory Defaults

The wireless access point settings are stored in the configuration file. You can save this file (back it up) to a computer, restore it from a computer, or reset it to factory default settings.

- *Save the Configuration*
- *Restore the Configuration*
- *Restore the Wireless Access Point to the Factory Default Settings*
- *Reboot the Wireless Access Point Without Restoring the Default Configuration*

Save the Configuration

➤ To save your settings:

1. Select **Maintenance > Upgrade > Backup Settings**.

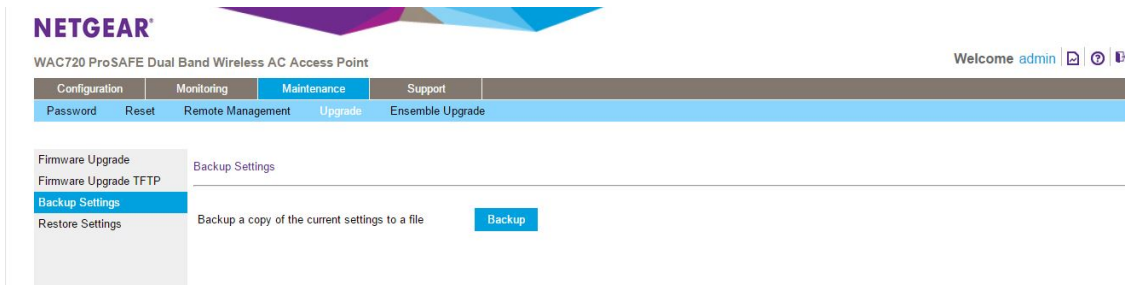

2. Click the **Backup** button.

Your browser extracts the configuration file (the file name is `config`) from the wireless access point and prompts you for a location on your computer to store the file.

3. Follow the instructions of your browser to save the file.

Restore the Configuration

IMPORTANT:

During the restoration process, do not try to go online, turn off the wireless access point, shut down the computer, or do anything else to the wireless access point until it finishes restarting!

➤ To restore your settings from a saved configuration file:

1. Select **Maintenance > Upgrade > Restore Settings**.

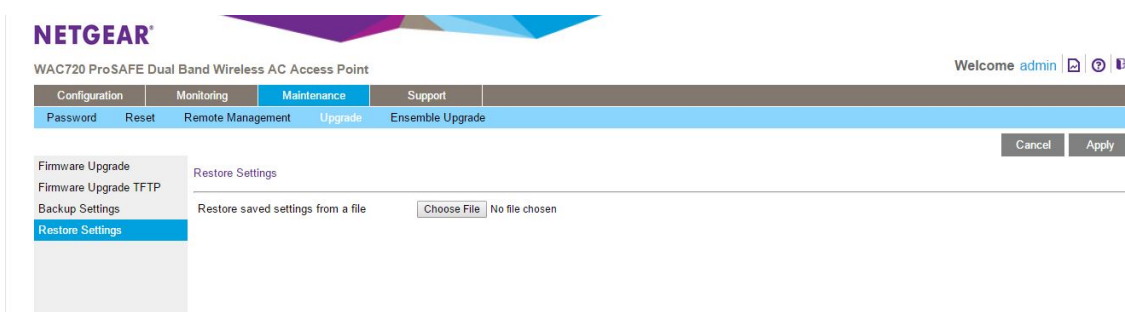

2. Click the **Browse** button and locate the backup configuration file (the file name is `config`).
3. Click the **Apply** button to initiate the restoration process.

During the restoration process, the wireless access point automatically restarts. The restoration process typically takes about one minute. When the Test LED turns off, wait a few more seconds before doing anything with the wireless access point.

Restore the Wireless Access Point to the Factory Default Settings

You can restore the wireless access point to the factory default settings by two methods that are described in the following sections:

- *Use the Web Management Interface to Restore Factory Default Settings*
- *Use the Reset Button to Restore Factory Default Settings*

Note: After you restore the factory default settings on the wireless access point, the following occurs:

- * All custom configurations are lost.
 - * The login password is **password**.
 - * The default LAN IP address is **192.168.0.100**.
 - * The DHCP client is disabled.
 - * The **Access Point Name** field is reset to the name printed on the label on the bottom of the unit.
-

Use the Web Management Interface to Restore Factory Default Settings

IMPORTANT:

During the restoration process, do not try to go online, turn off the wireless access point, shut down the computer, or do anything else to the wireless access point until it finishes restarting!

- To restore the factory default settings using the web management interface:

1. Select **Maintenance > Reset > Restore Defaults**.

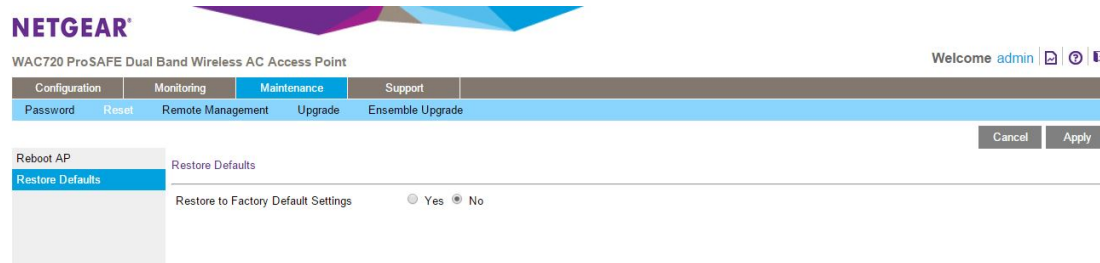

2. Select the **Yes** radio button. (By default, the **No** radio button is selected.)

3. Click the **Apply** button.

The wireless access point is reset to the factory default settings.

During the restoration process, the wireless access point automatically restarts. The restoration process typically takes about one minute. When the Test LED turns off, wait a few more seconds before doing anything with the wireless access point.

Use the Reset Button to Restore Factory Default Settings

To restore the factory default settings when you do not know the login user name, login password, or IP address, you must use the **Reset** button on the rear panel of the wireless access point (see *Figure 2* on page 9).

- **To restore the factory default settings using the Reset button:**

1. Using a sharp object, press and hold the **Reset** button for about five seconds (until the Test LED blinks rapidly) to reset the wireless access point to factory defaults settings.

Note: Pressing the **Reset** button for a shorter time simply causes the wireless access point to reboot.

2. Release the **Reset** button.

During the restoration process, the wireless access point automatically restarts. The restoration process typically takes about one minute. When the Test LED turns off, wait a few more seconds before doing anything with the wireless access point.

Reboot the Wireless Access Point Without Restoring the Default Configuration

If you do not have physical access to the wireless access point to switch it off and on again, you can use the software to reboot the wireless access point.

- **To reboot the wireless access point:**

1. Select **Maintenance > Reset > Reboot AP**.

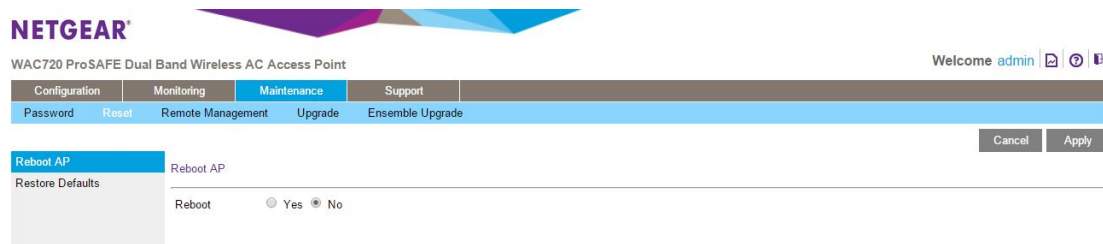

2. Select the **Yes** radio button. (By default, the **No** radio button is selected.)
3. Click the **Apply** button to reboot the wireless access point.

The reboot process typically takes about one minute. When the Test LED turns off, wait a few more seconds before doing anything with the wireless access point.

Change the Administrator Password

The default password is **password**. We recommend that you change this password to a more secure password. You cannot change the administrator login name (admin).

The ideal password contains no dictionary words from any language and is a mixture of letters (both uppercase and lowercase), numbers, and symbols. Your password can be up to 30 characters.

➤ To change the administrator password:

1. Select **Maintenance > Password > Change Password**.

2. Take one of the following actions:

- Enter a new password twice, once in the **New Password** field and again in the **Repeat New Password** field.
- Next to **Restore Default Password**, select the **Yes** radio button to restore the default password. By default, the **No** radio button is selected.

3. Click the **Apply** button to save your settings.

If you restored the default password, the login password is **password**. If you configured a new password, write it down in a secure place.

Manage User Accounts

The admin user account is the default user account, which you cannot delete. However, you can add other user accounts, modify them, and delete them. Users for whom you set up an account can access the web management interface with read-only or read/write privileges.

Note: Only the administrator can create, change, and delete user accounts.

➤ **To add a new user account:**

1. Select **Configuration > System > Advanced > User Accounts**.

2. Configure the settings in the upper part of the page as explained in the following table:

Setting	Description
User Name	Enter a new user name
Password	Enter a password between 4 and 12 characters in length.
Privilege	From the Privilege menu, select Read Write or Read Only .

3. Click the **Add** button.

The user account is added.

4. Click the **Apply** button.

Your settings are saved.

➤ **To change the name for a user account:**

1. On the **User Accounts** page, in the lower part of the page, select a user from the **Existing Users** menu.
2. In the **User Name** field, modify the name.
3. Click the **Modify** button.

The user name is changed.

4. Click the **Apply** button.

Your settings are saved.

➤ **To change the privilege for a user account:**

1. On the **User Accounts** page, in the lower part of the page, select a user from the **Existing Users** menu.
2. From the **Privilege** menu, select another privilege.

3. Click the **Reset Password** button. The password is reset to the default password, which is **password**.
4. Click the **Apply** button.
Your settings are saved.

➤ **To reset the password for a user account:**

1. On the **User Accounts** page, in the lower part of the page, select a user from the **Existing Users** menu.
2. Click **Reset Password**. The password is reset to the default password, which is password.
3. Click **Apply** to save your settings.

Note: If you want to modify a password, delete the user account, and then recreate the user account with the password of your choice.

➤ **To delete a user account:**

1. On the **User Accounts** page, in the lower part of the page, select a user from the **Existing Users** menu.
2. Click the **Delete** button.
3. Click the **Apply** button.
Your settings are saved.

Enable the Syslog Server

You can enable the syslog option if your LAN includes a syslog server. If syslog is enabled, the wireless access point sends its syslog files to the syslog server.

➤ **To enable a syslog server:**

1. Select **Configuration > System > Advanced > Syslog**.

The screenshot shows the NETGEAR management interface for a WAC720 ProSAFE Dual Band Wireless AC Access Point. The user is logged in as 'admin'. The navigation menu includes Configuration, Monitoring, Maintenance, and Support. Under Configuration, the 'System' tab is selected, and the 'Advanced' sub-tab is active. The 'Syslog' configuration page is displayed, featuring a sidebar with a tree view containing 'Basic', 'Advanced', 'General', 'Syslog', 'Ethernet LLDP', 'Bonjour', and 'User Accounts'. The 'Syslog' section has three fields: 'Enable Syslog' (a checkbox), 'Syslog Server IP Address' (an empty text input field), and 'Port Number' (a text input field containing the value '514'). 'Cancel' and 'Apply' buttons are located at the bottom right of the configuration area.

Specify the settings as explained in the following table:

Setting	Description
Enable Syslog	Select the check box to enable the syslog option. By default, the syslog option is disabled.
Syslog Server IP Address	Enter the IP address of the syslog server to which the wireless access point sends the syslog files.
Port Number	Enter the port number that is configured on the syslog server. The default port number is 514.

2. Click the **Apply** button.

Your settings are saved.

Monitor the Wireless Access Point

- [View System Information](#)
- [Monitor Wireless Stations](#)
- [View the Activity Log](#)
- [Traffic Statistics](#)

View System Information

You can view a summary of the current wireless access point configuration settings, including current IP settings and current wireless settings. This information is read only, so any changes must be made on other pages.

- **To view the System page:**

Select **Monitoring > System**.

ProSAFE Dual-Band Wireless AC Access Point WAC720 WAC730

The screenshot shows the Netgear management interface for a ProSAFE Dual-Band Wireless AC Access Point. The 'System' page is active, displaying the following information:

- Access Point Information:**
 - Access Point Name: netgear80586f
 - Ethernet MAC Address: 50:6A:03:80:58:6F
 - Wireless MAC Address for 2.4 GHz: 50:6A:03:80:58:60
 - Wireless MAC Address for 5 GHz: 50:6A:03:80:58:70
 - Ethernet LLDP: Enabled
 - Country / Region: United States
 - Firmware Version: 3.1.0.2
 - Serial Number: 4D8156E300021
 - Current Time: Fri Dec 31 1999 14:51:24 PST
 - AP Uptime: 0 days, 2 hours, 51 minutes
- Current IPv4 Settings:**
 - IPv4 Address: 192.168.0.100
 - Subnet Mask: 255.255.255.0
 - Default Gateway: (empty)
 - DHCP Client: Enabled
- Current IPv6 Settings:**
 - IPv6 Address: ::
 - Prefix Length: 0
 - Dynamic IPv6 Address: n/a
 - Default Gateway: ::
 - LAN IPv6 Link-Local Address: fe80::526a:3fff:fe80:586f/64
 - DHCP Client: Disabled

The following table explains the fields of the System page:

Setting	Description
Access Point Information	
Access Point Name	The NetBIOS name. For information about how to change the default name, see Configure Basic General System Settings and Time Settings on page 16.
Ethernet MAC Address	The MAC address of the wireless access point's Ethernet port.
Wireless MAC Address for 2.4 GHz	The MAC address of the wireless access point's wireless card when operating at 2.4 GHz.
Wireless MAC Address for 5 GHz	The MAC address of the wireless access point's wireless card when operating at 5 GHz.
Ethernet LLDP	Enabled indicates that LLDP is enabled. Disabled indicates that it is not.
Country/Region	The country or region for which the wireless access point is licensed for use. For information about how to change the country or region, see Configure Basic General System Settings and Time Settings on page 16. Note: It might not be legal to operate this wireless access point in a country or region other than one of those identified in this field.
Firmware Version	The version of the firmware that is currently installed.

Setting	Description
Serial Number	The serial number of the wireless access point.
Current Time	The current time. For information about how to change the time settings, see Configure Basic General System Settings and Time Settings on page 16.
AP Uptime	The length of time since the access point became active.
Current IPv4 Settings	
For information about how to change any of these IP settings, see Configure the IPv4 Settings on page 18.	
IP Address	The IPv4 address of the wireless access point.
Subnet Mask	The subnet mask for the address of the wireless access point.
Default Gateway	The default IPv4 gateway for the wireless access point communication.
DHCP Client	Enabled indicates that the current IP address was obtained from a DHCPv4 server on your LAN network. Disabled indicates a static IP configuration.
Current IPv6 Settings	
For information about how to change any of these IP settings, see Configure IPv6 Settings on page 72.	
IPv6 Address	The default IPv6 address of the wireless access point.
Prefix Length	The prefix length for the address of the wireless access point.
Dynamic IPv6 Address	The dynamically assigned IPv6 address if the DHCPv6 server has the stateful option enabled.
Default Gateway	The default IPv6 gateway for the wireless access point communication.
LAN IPv6 Link-Local Address	This is an automatically generated IPv6 address that uses the IPv4 address in the interface portion of its address.
DHCP Client	Enabled indicates that the current IP address was obtained from a DHCPv6 server on your LAN network. Disabled indicates a static IP configuration.
Current Wireless Settings for 802.11b, 802.11g, or 802.11ng and Current Wireless Settings for 802.11a or 802.11na	
Note: The section heading depends on the configured wireless mode.	
Access Point Mode	The operating mode of the wireless access point. One of the following modes is indicated: <ul style="list-style-type: none"> • Access Point • Point-to-Point Bridge • Point-to-Point Bridge with Access Point • Multi-Point Bridge with/without client association For information about how to change the mode, see Configure Wireless Bridging on page 89.

Setting	Description
Channel / Frequency	The channel that the wireless port is using. For information about how to change the channel and frequency, see Configure 802.11bg/ng/bgn Wireless Settings on page 20 and Configure 802.11a/a-na-ac Wireless Settings on page 22.
Rogue AP Detection	Enabled indicates that rogue AP detection is enabled. Disabled indicates that it is not.

Monitor Wireless Stations

The Wireless Stations page contains the Available Wireless Stations table. This table shows all IP devices that are associated with the wireless access point in the wireless network that is defined by the wireless network name (SSID). The table headings indicate the wireless modes (802.11bg, 802.11ng, or 802.11bgn for the 2.4 GHz band and 802.11a, 802.11na or 802.11ac for the 5 GHz band).

Note: A wireless network can include multiple wireless access points, all using the same network name (SSID). This uniformity extends the reach of the wireless network and allows users to roam from one wireless access point to another, providing seamless network connectivity. Under these circumstances, be aware that the Available Wireless Stations table includes only the stations associated with this wireless access point.

➤ To view the attached wireless stations, and to view details for a wireless station:

1. Select **Monitoring > Wireless Stations**.

The screenshot shows the NETGEAR web interface for a WAC720 ProSAFE Dual Band Wireless AC Access Point. The 'Monitoring' tab is selected, and the 'Wireless Stations' sub-tab is active. The page displays two tables of available wireless stations. The first table is for 802.11bg/ng/bgn and the second is for 802.11a/a-na-ac. Both tables have columns for MAC Address, BSSID, SSID, Channel, Rate, State, Type, Tx Bytes, Rx Bytes, Mode, and Status. There are 'Refresh' and 'Details' buttons at the top right of the tables.

The Available Wireless Stations table shows the MAC address, BSSID, SSID, channel, rate, state, type, AID, mode, and status for each device. For information about these and more fields, see the following table.

2. To update the list, click **Refresh**.

If the wireless access point is rebooted, the wireless station data is lost until the wireless access point rediscovers the devices. To force the wireless access point to look for associated devices, click **Refresh**.

- To view details of a wireless station, select the corresponding radio button, and then click **Details**.

The Wireless Stations Details page displays.

The following table explains the fields of the Wireless Stations Details page:

Setting	Description
MAC Address	The MAC address of the wireless station.
BSSID	The BSSID that the wireless station is using.
SSID	The SSID that the wireless station is using.
Channel	The channel that the wireless station is using.
Rate	The transmit data rate in Mbps of the wireless station.
State	The features that are enabled on the wireless station.
Type	The authentication and encryption type that the wireless station is using.
AID	The associated identifier (AID) of the wireless station.
Mode	The wireless mode in which the wireless station is operating.
Status	The wireless status of the wireless station (Associated).
RSSI	The received signal strength indicator (RSSI) of the wireless station.
Idle Time	The time since the last frame was received from the wireless station.
Tx Sequence	The sequence number of the last frame that was transmitted to the wireless station.
Rx Sequence	The sequence number of the last frame that was received from the wireless station.
Capability	The summary of the capability of the wireless station that was detected during association.
Cipher	The cipher that the wireless station is using and that defines the type of encryption.
SNR	The signal-to-noise ratio (SNR) that indicates how much the signal of the wireless station has been corrupted by noise.
Recv. Bytes	The number of bytes received on the wireless station since it last started.
Trans. bytes	The number of bytes transmitted by the wireless station since it last started.
Assoc. Time Stamp	The time when these details of the wireless station were retrieved.
IP Address	The IP address of the wireless station.
Channel Width	The channel width at which the wireless station operates.

View the Activity Log

You can view the wireless access point's activity logs and save the logs.

➤ To display the activity log and save it:

1. Select **Monitoring > Logs**.

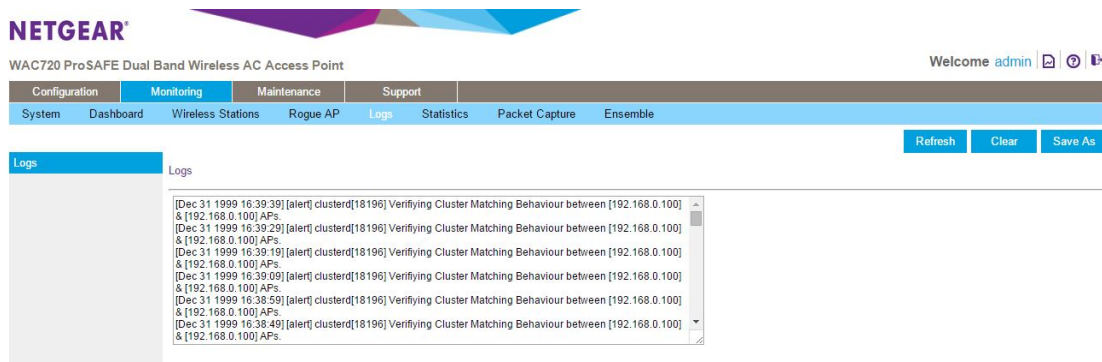

2. Click the **Save As** button to save the log contents to a file on your computer or to a disk drive.
3. To update the display, click the **Refresh** button.
4. To clear the log content, click the **Clear** button.

Traffic Statistics

The Statistics page displays information for both wired (LAN) and wireless (WLAN) network traffic.

➤ To display the Statistics page:

1. Select **Monitoring > Statistics**.

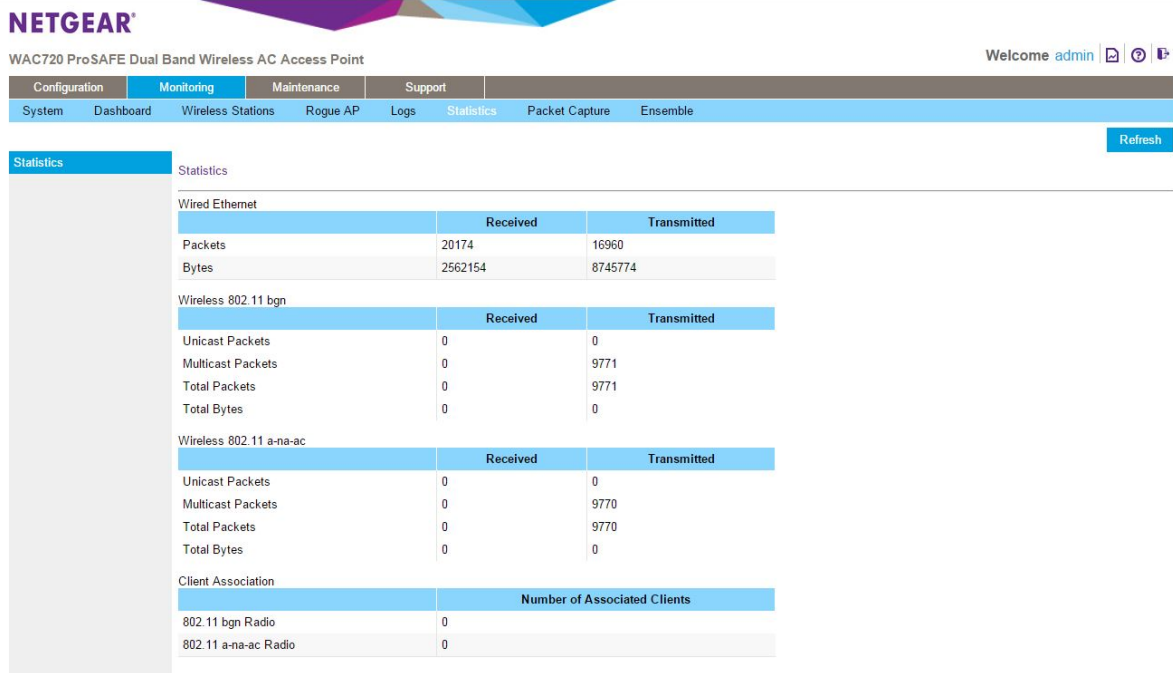

2. To update the statistics information, click the **Refresh** button.

The following table explains the fields of the Statistics page:

Setting	Description
Wired Ethernet	
Packets	The number of packets received and transmitted over the Ethernet connection since the wireless access point was restarted.
Bytes	The number of bytes received and transmitted over the Ethernet connection since the wireless access point was restarted.
Wireless 802.11bgn and Wireless 802.11a-na-ac	
Note: The section heading depends on the configured wireless mode.	
Unicast Packets	The number of unicast packets received and transmitted over the wireless connection since the wireless access point was restarted.
Broadcast Packets	The number of broadcast packets received and transmitted over the wireless connection since the wireless access point was restarted.
Multicast Packets	The number of multicast packets received and transmitted over the wireless connection since the wireless access point was restarted.
Total Packets	The total number of packets received and transmitted over the wireless connection since the wireless access point was restarted.
Total Bytes	The total number of bytes received and transmitted over the wireless connection since the wireless access point was restarted.
Client Association	
802.11bgn Radio, 802.11a-na-ac Radio	The number of associated clients connected to the radio in the configured wireless modes.

Enable and Configure Ensemble Mode

An AP ensemble is a dynamic, configuration-aware group of APs in the same subnet of a network. Each ensemble can include up to 16 members, up to 10 APs of the same model. Only one ensemble per wireless network is supported. However, a network subnet can include multiple ensembles. Ensembles allow APs to share various configuration information, such as VAP settings and QoS queue parameters.

Ensemble members share the configuration of the dominant AP.

An ensemble can be formed between two APs if the following conditions are met:

- The APs use the same radio mode.
- The APs are connected on the same bridged segment.
- The APs joining the ensemble have the same ensemble name.
- Ensemble mode is enabled on both APs.

Configure Ensemble Mode

- To configure Ensemble mode on the access point:

1. Select **Configuration > Ensemble**.

The screenshot shows the Netgear web management interface for a WAC720 ProSAFE Dual Band Wireless AC Access Point. The user is logged in as 'admin'. The navigation menu includes Configuration, Monitoring, Maintenance, and Support. The 'Ensemble' tab is selected under the Configuration section. The left sidebar shows 'Basic' and 'Advanced' sections. Under 'Basic', 'Ensemble General' is selected. The main content area shows the 'Ensemble General' configuration page with the following settings:

- Ensemble Mode: Start Stop
- Ensemble Name:
- AP Name:
- Priority (0 - 255):

Buttons for 'Cancel' and 'Apply' are visible at the bottom right of the configuration area.

2. To enable Ensemble mode, select the **Start** radio button.
 3. In the **Ensemble Name** field, enter the ensemble name.
 4. Set the access point's priority in the ensemble.

The lowest numbered AP becomes the dominant AP.

5. Click the **Apply** button to save your settings.

Manage an Ensemble

An ensemble can be managed through the dominant access point's web management interface, or through a configured IP address of the ensemble. You can manage an ensemble's channel assignment settings, upgrade settings, and security settings.

- To manage an Ensemble's channel assignment settings:

1. Select **Configuration > Ensemble > Advanced > Channel Assignment Settings**.

The screenshot shows the Netgear web management interface for a WAC720 ProSAFE Dual Band Wireless AC Access Point. The user is logged in as 'admin'. The navigation menu includes Configuration, Monitoring, Maintenance, and Support. The 'Ensemble' tab is selected under the Configuration section. The left sidebar shows 'Basic' and 'Advanced' sections. Under 'Advanced', 'Channel Assignment' is selected. The main content area shows the 'Channel Assignment Settings' page with the following settings:

- Ensemble Status:
- Channel Interference Limit:
- Channel Selection Interval:

Buttons for 'Cancel' and 'Apply' are visible at the bottom right of the configuration area.

2. From the **Channel Interference Limit** menu, select an interference limit percentage.
 3. Select an channel selection interval from the **Channel Selection Interval** menu.
 4. Click **Apply** to save your settings.

You can monitor the channel's used by the access points in the ensemble by selecting **Configuration > Ensemble > Advanced > Channel Assignment**.

➤ To manage an Ensemble's firmware versions:

1. Select **Maintenance > Ensemble Upgrade > Firmware Upgrade**.

The screenshot shows the NETGEAR web interface for a WAC720 ProSAFE Dual Band Wireless AC Access Point. The user is logged in as 'admin'. The navigation menu includes Configuration, Monitoring, Maintenance, and Support. Under Maintenance, there are links for Password, Reset, Remote Management, Upgrade, and Ensemble Upgrade. The 'Firmware Upgrade' page is active, showing a 'Member Selection' table with one member selected. Below the table is an 'Upload Firmware' section with a 'Choose File' button and an 'Upgrade' button. A caution message at the bottom states: 'Caution: Uploading the new firmware may take several minutes. Please do not refresh the page or navigate to another page while uploading the new firmware, or the firmware upload will be aborted. When the process is complete the access point will restart and resume normal operation.'

Members	IP Address	MAC Address	Master AP	Firmware Version	Firmware-transfer-status
<input checked="" type="checkbox"/>	192.168.0.100	50:6A:03:80:58:6F	yes	3.1.0.2	None

2. Click the **Choose File** button.
3. Select a firmware file to upload.
4. Select the members of the ensemble that you would like to upgrade.
5. Click the **Upgrade** button.

You can also use a TFTP server to upgrade the firmware by selecting **Maintenance > Ensemble Upgrade > Firmware Upgrade TFTP**.

➤ To manage an ensemble's password:

1. Select **Configuration > Ensemble > Secured Ensemble**.

The screenshot shows the NETGEAR web interface for a WAC720 ProSAFE Dual Band Wireless AC Access Point. The user is logged in as 'admin'. The navigation menu includes Configuration, Monitoring, Maintenance, and Support. Under Configuration, there are links for System, IP, Wireless, Security, Wireless Bridge, Ensemble, and Captive Portal. The 'Secured Ensemble' page is active, showing the 'Ensemble Status' as 'Stopped' and the 'Secure Mode' as 'Enabled'. The 'Passphrase' field is empty, and the 'Re-authentication Timeout' is set to 300 seconds.

2. Choose the **Enabled** radio button.
3. Enter a passphrase between 8 and 63 characters in the **passphrase** field.
4. Enter a timeout period between 300 and 86400 seconds.
5. Click the **Apply** button.

Monitor an Ensemble

You can monitor the status of an ensemble from the ensemble dashboard. You can also monitor the devices connected to members of the ensemble as well as monitor networks neighboring the ensemble.

➤ To monitor the status of the Ensemble:

1. Select **Monitor > Ensemble > Access Point**.

NETGEAR
WAC720 ProSAFE Dual Band Wireless AC Access Point

Welcome admin

Configuration Monitoring Maintenance Support
System Dashboard Wireless Stations Rogue AP Logs Statistics Packet Capture Ensemble

Access Point Refresh

Wireless Stations
Wireless Neighborhood

AP Name	MAC Address	IP Address	Ensemble Priority	Master AP	Firmware version	2.4GHz Channel	5GHz Channel	Uptime in Ensemble	Status
netgear80586f	50:6A:03:80:58:6F	192.168.0.100	0	no	3.1.0.2	1	36	0 days 0 hours 0 minutes	Connected

**NOTE: This table takes few minutes to get updated.

2. Click the **Refresh** button.

➤ To monitor the devices connected to the Ensemble:

1. Select **Monitor > Ensemble > Wireless Stations**.

NETGEAR
WAC720 ProSAFE Dual Band Wireless AC Access Point

Welcome admin

Configuration Monitoring Maintenance Support
System Dashboard Wireless Stations Rogue AP Logs Statistics Packet Capture Ensemble

Access Point Refresh

Wireless Stations
Wireless Neighborhood

AP Name	Station MAC	Station Idle Time	Rate	RSSI	Tx Bytes	Rx Bytes	Error Rate
---------	-------------	-------------------	------	------	----------	----------	------------

**NOTE: Maximum of 20 clients per radio of each AP will be displayed. To view all clients, please access individual AP.

2. Click the **Refresh** button.

The devices connected to the ensemble display, listed by MAC address.

➤ To monitor the networks neighboring the Ensemble:

1. Select **Monitor > Ensemble > Wireless Neighborhood**.

NETGEAR
WAC720 ProSAFE Dual Band Wireless AC Access Point

Welcome admin

Configuration Monitoring Maintenance Support
System Dashboard Wireless Stations Rogue AP Logs Statistics Packet Capture Ensemble

Access Point Refresh

Wireless Stations
Wireless Neighborhood

Neighbor APs (In Ensemble/Not-in Ensemble/Both) In Ensemble

Neighbor AP (25)	192.168.0.100	192.168.0.100
NETGEAR_11ng	50:6A:03:80:58:60 (netgear80586f)	50:6A:03:80:58:70 (netgear80586f)
NETGEAR_11ac		

2. Select the kind of neighboring APs to display from the **Neighbor APs** menu.

You can select either APs in the ensemble, APs not in the ensemble, or both.

The APs display in the Wireless Neighborhood table.

Advanced Configuration

5

This chapter describes how to configure the advanced features of the wireless access point. The chapter includes the following sections:

- *Configure IPv6 Settings*
- *Configure Spanning Tree Protocol, 802.1Q VLAN, and Link Layer Discovery Protocol*
- *Configure Advanced Wireless Settings*
- *Configure Advanced Quality of Service Settings*
- *Configure Quality of Service Policies*
- *Configure Wireless Bridging*

Configure IPv6 Settings

The wireless access point supports IPv6:

- You can manage the wireless access point from an IPv6 address.
- The wireless access point can function as an IPv6 DHCP client.

Configure the IPv6 Settings

Note: For information about how to configure the IPv4 settings, see *Configure the IPv4 Settings* on page 18.



WARNING:

If you enable the DHCP client, the IP address of the wireless access point changes when you click the Apply button, causing you to lose your connection to the wireless access point. You then must use the new IP address to reconnect to the wireless access point.

Tip: If you enable the DHCP client on the wireless access point, you can discover the new IP address of the wireless access point by accessing the DHCP server on your LAN, or by using a network IP address scanner application.

➤ To configure the IPv6 settings:

1. Select **Configuration > IP > IPv6 Settings**.

The screenshot shows the Netgear configuration web interface for a WAC720 ProSAFE Dual Band Wireless AC Access Point. The user is logged in as 'admin'. The navigation menu includes Configuration, Monitoring, Maintenance, and Support. Under Configuration, there are links for System, IP, Wireless, Security, Wireless Bridge, Ensemble, and Captive Portal. The 'IP Settings' section is expanded to show 'IPv6 Settings'. The settings include:

- DHCP Client: Enable Disable
- IPv6 Address:
- Prefix Length:
- Default Gateway:
- Dynamic IPv6 Address:
- Primary DNS Server:
- Secondary DNS Server:
- Network Integrity Check:

Buttons for 'Cancel' and 'Apply' are visible at the bottom right of the configuration area.

2. Configure the IPv6 settings as explained in the following table:

Setting	Description
DHCP Client	By default, the Dynamic Host Configuration Protocol (DHCP) client is disabled. If you have a DHCPv6 server on your LAN and you select the Enable radio button, the wireless access point receives its dynamic IPv6 address, prefix length, and default gateway settings automatically from the DHCPv6 server on your network when you connect the wireless access point to your LAN.
IPv6 Address	Enter the IP address of your wireless access point. The default IP address is 2001::21c:c0ff:fe69 . To change the address, enter an unused IPv6 address from the address range used on your LAN.
Prefix Length	Enter the prefix length for the IPv6 address. The default prefix length is 64.
Default Gateway	Enter the IPv6 address of the ISP gateway to which the wireless access point connects.
Dynamic IPv6 Address	The dynamic IPv6 address that is assigned by the DHCPv6 server on your network. This address does not overwrite the address in the IPv6 Address field.
Primary DNS Server	Enter the IP address of the primary and secondary DNS servers. A DNS server is a host on the Internet that translates Internet names (such as www.netgear.com) to numeric IP addresses. Typically your ISP transfers the IP address of one or two DNS servers to your wireless access point during login. If the ISP does not transfer an address, you must obtain it from the ISP and enter it manually in this field.
Secondary DNS Server	
Network Integrity Check	Select this check box to validate that the upstream link is active before allowing wireless associations. Ensure that the default gateway is configured.

3. Click **Apply** to save your settings.

Configure Spanning Tree Protocol, 802.1Q VLAN, and Link Layer Discovery Protocol

As part of the advanced system configuration, you can enable the Spanning Tree Protocol (STP), configure the VLANs, and enable Ethernet Link Layer Discovery Protocol (LLDP) as described in the following sections.

- [Configure STP and VLANs](#)
- [Configure Ethernet LLDP](#)

Configure STP and VLANs

STP provides network traffic optimization in locations where multiple wireless access points are active by preventing path redundancy. We recommend that you enable STP if you have more than one active wireless access point at your location.

The 802.1Q VLAN protocol on the wireless access point logically separates traffic on the same physical network:

- **Untagged VLAN.** When the wireless access point sends frames that are associated with the untagged VLAN from its Ethernet interface, those frames are untagged. When the wireless access point receives untagged frames over its Ethernet interface, those frames are assigned to the untagged VLAN.

Note: Select the **Untagged VLAN** check box only if the hubs and switches on your LAN support the 802.1Q VLAN protocol. Likewise, change the untagged VLAN value only if the hubs and switches on your LAN support the 802.1Q VLAN protocol.

- **Tagged VLAN.** When you clear the **Untagged VLAN** check box, the wireless access point tags all frames that are sent from its Ethernet interface. Only incoming frames that are tagged with known VLAN IDs are accepted.
- **Management VLAN.** The management VLAN can be active only when the wireless access point functions as a point-to-point or point-to-multipoint bridge (see *Configure Wireless Bridging* on page 89). The management VLAN is used for managing traffic (Telnet, SNMP, and HTTP) to and from the wireless access point.

Frames belonging to the management VLAN are not given any 802.1Q header when they are sent over the trunk. If a port is in a single VLAN, it can be untagged. However, if the port is a member of multiple VLANs, it needs to be tagged.

➤ **To configure STP and VLANs:**

1. Select **Configuring > System > Advanced > General.**

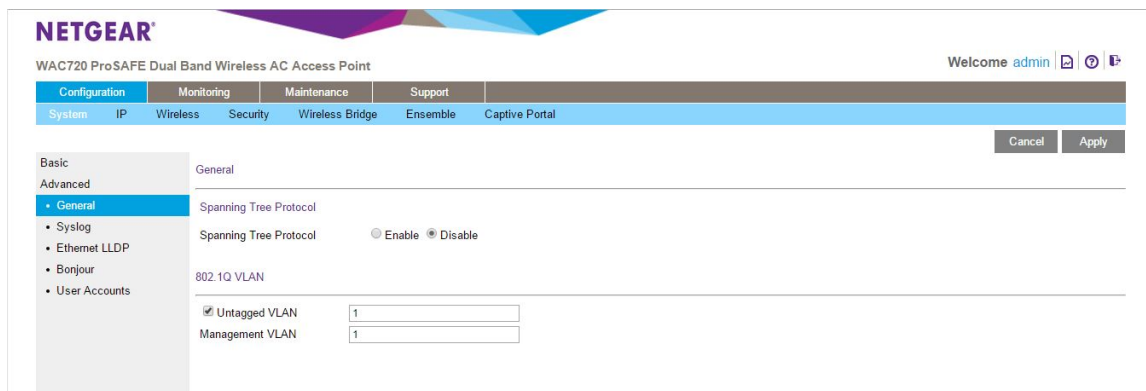

2. Specify the settings as explained in the following table:

Setting	Description
Spanning Tree Protocol	
Spanning Tree Protocol	Select the Enable radio button to enable STP to prevent path redundancy. By default, the Disable radio button is selected.

Setting	Description
802.1Q VLAN	
Untagged VLAN	Select the Untagged VLAN check box to configure one VLAN as an untagged VLAN. By default, the Untagged VLAN check box is selected. Specify a VLAN ID. The default VLAN ID is 1.
Management VLAN	Specify an ID for the VLAN from which the wireless access point can be managed. The default VLAN ID is 1. Note: If you configure the management VLAN ID as 0 (zero), the wireless access point can be managed over any VLAN, and frames that belong to the management VLAN are not tagged with an 802.1Q header when sent over the trunk.

**WARNING:**

Selecting the **Untagged VLAN** check box or changing the untagged VLAN value causes loss of IP connectivity if the hubs and switches on your LAN have not yet been configured with the corresponding VLAN.

- Click **Apply** to save your settings.

Configure Ethernet LLDP

Link Layer Discovery Protocol (LLDP), IEEE 802.1ab, is a management tool that delivers link-layer messages to adjacent network devices. For example, LLDP messages enable networking devices such as switches and management tools to discover the wireless access point in the network, and might indicate whether the wireless access point receives power through a PoE connection. LLDP is inter-vendor compatible.

By default, LLDP is enabled on the wireless access point.

➤ **To turn off LLDP:**

- Select **Configuring > System > Advanced > Ethernet LLDP**.

- Select the **Disable** radio button.

By default, the **Enable** radio button is selected.

3. Click **Apply** to save your settings.

Configure Bonjour

Bonjour allows computers on the network to discover the access point more easily after it connects to a LAN that includes a DHCP server.

➤ To enable Bonjour:

1. Select **Configuration > System > Advanced > Bonjour**.

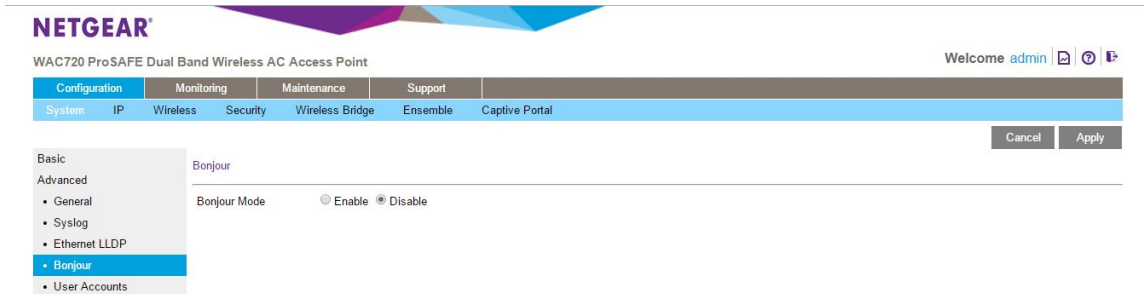

2. Select the **Enable** radio button.
3. Click the **Apply** button to save your changes.

Configure Advanced Wireless Settings

You can configure and enable various WLAN settings for the 802.11b/bg/ng and 802.11a/na modes. Band steering is an advanced wireless feature that reduces the client density in the 2.4 GHz band and increases the wireless network capacity.

The default WLAN settings normally work well. However, you can use the advanced settings to fine-tune the overall performance of the wireless access point for your specific environment.

➤ To configure advanced wireless settings:

1. Select **Configuration > Wireless > Advanced > Wireless Settings**.

ProSAFE Dual-Band Wireless AC Access Point WAC720 WAC730

2. Specify the settings as explained in the following table:

Setting	Description
RTS Threshold (0–2347)	<p>Enter the Request to Send (RTS) threshold. The default setting is 2347.</p> <p>If the packet size is equal to or less than the RTS threshold, the wireless access point uses the Carrier Sense Multiple Access with Collision Detection (CSMA/CD) mechanism, and the data frame is transmitted immediately after the silence period.</p> <p>If the packet size is larger than the RTS threshold, the wireless access point uses the CSMA with Collision Avoidance (CSMA/CA) mechanism. In this situation, the transmitting station sends an RTS packet to the receiving station and waits for the receiving station to return a Clear to Send (CTS) packet before sending the actual packet data.</p>
Fragmentation Length (256–2346)	<p>Enter the maximum packet size that is used for the fragmentation of data packets. Packets that are larger than the specified fragmentation length are broken up into smaller packets before being transmitted. The fragmentation length needs to be an even number. The default setting is 2346.</p>
Beacon Interval (100–1000)	<p>Enter the interval between 100 ms and 1000 ms for each beacon transmission, which allows the wireless access point to synchronize the wireless network. The default setting is 100.</p>

Setting	Description
AMPDU	Select the Enable radio button to allow the aggregation of several MAC frames into a single large frame to achieve higher throughput. Enabling the aggregated MAC protocol data unit (A-MPDU) could lead to better network performance. By default, the Enable radio button is selected.
RIFS Transmission	Select the Enable radio button to allow transmission of successive frames at different transmit powers. Enabling reduced interframe space (RIFS) could lead to better network performance. By default, the Disable radio button is selected.
DTIM Interval (1–255)	Enter the delivery traffic indication message (DTIM) interval, also referred to as the data beacon rate, which indicates the beacon delivery traffic indication message period in multiples of beacon intervals. This value needs to be between 1 and 255. The default setting is 3.
Antenna	Select one of the following radio buttons to specify the antenna: <ul style="list-style-type: none"> • Internal. Enables the internal antenna. This is the default setting. • External. Enables an optional external antenna or antennas.
802.11d Note: This setting does not apply to the 802.11a/a-na-ac modes.	Select this check box to enable support for additional regulatory domains that are not in the current standard; support includes the addition of a country information element to beacons, probe requests, and probe responses. This check box is selected by default.
Wireless Client Security Separation	From the menu, select one of the following options: <ul style="list-style-type: none"> • Enable. Communication between wireless clients that are associated to different virtual access points (VAPs) is blocked. • Disable. Communication between wireless clients that are associated to different VAPs is allowed. This is the default setting.
Max. Wireless Clients	Enter the maximum number of wireless clients that can simultaneously connect to the wireless access point at one time. The default setting is 128 clients.
Frame Burst	Frame-burst support boosts the downstream throughput. It is disabled by default.
Fixed Multicast Rate	Select the multicast traffic transmission rate you want the AP to support. The default value is Auto . For 2.4GHz radio, Auto value is 1 Mbps. For 5GHz radio, Auto value is 6 Mbps.
Broadcast/Multicast Rate	Enabling multicast and broadcast rate limiting may improve overall network performance by limiting the number of packets transmitted across the network. By default the Multicast/Broadcast Rate Limiting option is disabled. The default and maximum rate limit setting is 50 packets per second. The default and maximum rate limit burst setting is 75 packets per second.

3. Click **Apply** to save your settings.

Configure Advanced Quality of Service Settings

For most networks, the default Quality of Service (QoS) queue settings work well. For information about how to configure basic QoS, see *Configure Basic Wireless Quality of Service* on page 47.

You can specify the settings on multiple queues for increased throughput and better performance of differentiated wireless traffic such as Voice over IP (VoIP), other types of audio, video, and streaming media, as well as traditional IP data.

The advanced QoS options on the wireless access point are as follows:

- **AP EDCA parameters.** Specify the access point (AP) Enhanced Distributed Channel Access (EDCA) settings for different types of data transmitted from the wireless access point to wireless clients.
- **Station EDCA parameters.** Specify the station EDCA parameters for different types of data transmitted from the wireless clients to the wireless access point. If WMM is disabled, you cannot configure the Station EDCA parameters. (For information about how to enable WMM, see *Configure Basic Wireless Quality of Service* on page 47.)

When you configure the EDCA settings, the wireless access point can leverage existing information in the IP packet header that is related to the Type of Service (ToS). The wireless access point examines the ToS field in the headers of all packets that it processes. Based on the value in a packet's ToS field, the wireless access point prioritizes the packet for transmission by assigning it to one of the queues. A different type of data is associated with each queue. You can configure how the wireless access point treats each queue.

The queues defined for different types of data transmitted from AP-to-station and station-to-AP are as follows:

- **Data 0 (Best Effort).** Medium priority queue, medium throughput and delay. Most traditional IP data is sent to this queue.
- **Data 1 (Background).** Lowest priority queue, high throughput. Bulk data that requires maximum throughput and is not time-sensitive is sent to this queue (FTP data, for example).
- **Data 2 (Video).** Highest priority queue, minimum delay. Time-sensitive video data is automatically sent to this queue.
- **Data 3 (Voice).** Highest priority queue, minimum delay. Time-sensitive data such as VoIP and streaming media are automatically sent to this queue.

➤ To configure advanced QoS:

1. Select **Configuration > Wireless > Advanced > QoS Settings**. The advanced QoS Settings page displays:

2. Specify the settings as explained in the following table:

Setting	Description
AP EDCA parameters	
AIFS	Enter the Arbitration Inter-Frame Spacing (AIFS) interval that specifies the wait time (in milliseconds) between data frames. A higher AIFS value means a higher priority for a queue. Valid values for AIFS are 0 through 8. The default values are Data 0: 3; Data 1: 7; Data 2: 1; Data 3: 1.
cwMin	Enter the minimum contention window (cwMin) value that specifies the upper limit (in milliseconds) of a range from which the initial random back-off wait time is determined. Decreasing this value increases the priority of the queue. The value for cwMin needs to be lower than the value for cwMax. Valid values are 0, 1, 3, 7, 15, 31, 63, 127, 255, 511, and 1023. The default values are Data 0: 15; Data 1: 15; Data 2: 7; Data 3: 3.
cwMax	Enter the maximum contention window (cwMax) value that specifies the upper limit (in milliseconds) for the doubling of the random back-off value. Decreasing this value increases the priority of the queue. The value for cwMax needs to be higher than the value for cwMin. Valid values are 0, 1, 3, 7, 15, 31, 63, 127, 255, 511, and 1023. The default values are Data 0: 63; Data 1: 1023; Data 2: 15; Data 3: 7.

Setting	Description
Max. Burst	Enter the maximum burst value that specifies the maximum burst length (in microseconds) allowed for packet bursts on the wireless network. A packet burst is a collection of multiple frames transmitted without header information. Decreasing this value increases the priority of the queue. Valid values for maximum burst length are all multiples of 32 between 0 and 8192, inclusive of 0 and 8192. The default values are Data 0: 0; Data 1: 0; Data 2: 3008; Data 3: 1504.
Station EDCA parameters	
AIFS	Enter the Arbitration Inter-Frame Spacing (AIFS) interval that specifies the wait time (in milliseconds) between data frames. A higher AIFS value means a higher priority for a queue. Valid values for AIFS are 0 through 8. The default values are Data 0: 3; Data 1: 7; Data 2: 2; Data 3: 2.
cwMin	Enter the minimum contention window (cwMin) value that specifies the upper limit (in milliseconds) of a range from which the initial random back-off wait time is determined. Decreasing this value increases the priority of the queue. The value for cwMin needs to be lower than the value for cwMax. Valid values are 0, 1, 3, 7, 15, 31, 63, 127, 255, 511, and 1023. The default values are Data 0: 15; Data 1: 15; Data 2: 7; Data 3: 3.
cwMax	Enter the maximum contention window (cwMax) value that specifies the upper limit (in milliseconds) for the doubling of the random back-off value. Decreasing this value increases the priority of the queue. The value for cwMax needs to be higher than the value for cwMin. Valid values are 0, 1, 3, 7, 15, 31, 63, 127, 255, 511, and 1023. The default values are Data 0: 1023; Data 1: 1023; Data 2: 15; Data 3: 7.
TXOP Limit	Enter the transmission opportunity (TXOP) value that specifies the time interval (in microseconds) in which a client station can initiate transmissions on the wireless medium (WM). Decreasing this value increases the priority of the queue. Valid values for TXOP Limit are all multiples of 32 between 0 and 8192, inclusive of 0 and 8192. The default values are Data 0: 0; Data 1: 0; Data 2: 3008; Data 3: 1504.

3. Click **Apply** to save your settings.

Configure Quality of Service Policies

The wireless access point lets you configure and apply QoS policies to wireless clients. In each QoS policy, you can specify multiple classifications (match clauses) and apply traffic to eight priority queues based on the following information in the Layer 2, Layer 3, Layer 3 IP headers, and Layer 4:

- **IP precedence.** Indicates the IP Type of Service (ToS) or precedence in the IP headers.
- **IP DSCP.** Indicates the Differentiated Services Code Point (DSCP) marking in the IP header.
- **IP protocol 119.** Indicates the IP protocol field in the IP header with value 119.
- **802.1P.** Indicates the 3-bit Class of Service (CoS) field in the class header.
- **IP protocol.** Indicates the protocol field in the IP header.
- **EtherType.** Indicates the EtherType field in Ethernet-II frame header.

- **Source MAC.** Indicates the source MAC address in Ethernet-II frame header.
- **Destination MAC.** Indicates the destination MAC address in Ethernet-II frame header.
- **Source IP.** Indicates the source IP address in the IP header.
- **Destination IP.** Indicates the destination IP address in the IP header.
- **Source port.** Indicates the source port number in the port header.
- **Destination port.** Indicates the destination port number in the port header.

For each classification in a QoS policy, you can configure rate limiting by specifying the maximum bit rate and maximum burst rate. Packets that exceed the maximum bit rate are retained in the traffic queue and are processed when transmission falls again below the maximum bit rate. You can also configure the overall maximum bit rate and maximum burst rate for the entire wireless interface.

You can configure up to eight QoS policies.

➤ **To configure a new QoS policy:**

1. Select **Configuration > Wireless > Advanced > QoS Policies**.

The screenshot shows the NETGEAR configuration interface for a WAC720 ProSAFE Dual Band Wireless AC Access Point. The user is logged in as 'admin'. The navigation menu includes Configuration, Monitoring, Maintenance, and Support. Under Configuration, the 'Wireless' tab is selected, and the 'Advanced' sub-tab is active, showing 'QoS Policies'. The left sidebar lists 'Basic' and 'Advanced' settings, with 'QoS Policies' selected under 'Advanced'. The main content area shows two sections for creating QoS policies. The first section is for '802.11 b/g/n/bgn' and the second is for '802.11 a/a-na-ac'. Each section has a 'Create Policy' dropdown menu set to 'NEW', a 'Policy Name' text field containing 'NEW', and a 'Classifications' list box. Below the list box are 'Delete Policy' and 'Delete Classification' buttons. Further down are 'Match Frame Fields' (set to 'IP Precedence'), 'Match Classifications' (set to 'Routine(0)'), and 'Apply Classification' (set to 'Best Effort(0)') dropdowns, followed by an 'Add' button. At the bottom of each section are 'Classification Rate Limiting' fields for 'Basic Rate (1 - 1000000 kBytes/sec)' and 'Burst Rate (1 - 20480000 bytes/sec)', with an 'Add' button below them.

2. From the Create Policy menu, select **NEW**. If you have not created any QoS policies, **NEW** is the only selection possible.
3. In the **Policy Name** field, enter a name for the new QoS policy.
4. Specify a classification for the QoS policy as explained in the following table.

Note: Depending on your selection from the **Match Frame Fields** menu, **Match Classifications** appears either as a menu from which you must make a selection or a field in which you must enter information.

Setting	Description	
Match Frame Fields and Match Classifications	IP DSCP	<p>From the Match Classifications menu, select the DSCP traffic class against which the information in the IP header needs to be matched:</p> <ul style="list-style-type: none"> • Routine(0) • Priority(1) • Immediate(2) • Flash(3) • Flash Override(4) • Critic/CCP(5) • Inter Control(6) • Network Control(7)
	IP Precedence	<p>From the Match Classifications menu, select the DSCP marking against which the information in the IP header needs to be matched:</p> <ul style="list-style-type: none"> • Best Effort • Assured Forwarding - Class 1 Low • Assured Forwarding - Class 1 Medium • Assured Forwarding - Class 1 High • Assured Forwarding - Class 2 Low • Assured Forwarding - Class 2 Medium • Assured Forwarding - Class 2 High • Assured Forwarding - Class 3 Low • Assured Forwarding - Class 3 Medium • Assured Forwarding - Class 3 High • Assured Forwarding - Class 4 Low • Assured Forwarding - Class 4 Medium • Assured Forwarding - Class 4 High • Class Selector 1 • Class Selector 2 • Class Selector 3 • Class Selector 4 • Class Selector 5 • Class Selector 6 • Class Selector 7 • Expedited Forwarding
	IP Protocol119	Traffic is matched against value 119 in the IP protocol field in the IP header.

Setting	Description	
Match Frame Fields and Match Classifications (continued)	802.1P	<p>From the Match Classifications menu, select the CoS priority value against which the information in the IP header needs to be matched:</p> <ul style="list-style-type: none"> • Routine(0) • Priority(1) • Immediate(2) • Flash(3) • Flash Override(4) • Critic/CCP(5) • Inter Control(6) • Network Control(7)
	IP Protocol	<p>In the Match Classifications field, enter the IP protocol value against which the information in the IP header needs to be matched. A list of protocol values is available at http://www.iana.org/assignments/protocol-numbers/protocol-numbers.xml.</p>
	Ether Type	<p>In the Match Classifications field, enter the Ether type value against which the information in the IP header needs to be matched. A list of Ether type values is available at http://standards.ieee.org/develop/regauth/ethertype/eth.txt.</p>
	Source MAC	<p>In the Match Classifications field, select or enter the source MAC address against which the information in the IP header needs to be matched.</p> <p>To select the MAC address of a wireless client that is connected to the wireless access point:</p> <ol style="list-style-type: none"> 1. Select the radio button to the left of the Match Classifications menu. 2. From the menu, select a MAC address. <p>To enter a MAC address:</p> <ol style="list-style-type: none"> 1. Select the radio button to the right of the Match Classifications menu. 2. In the field to the right of the radio button, enter a MAC address.
	Destination MAC	<p>In the Match Classifications field, select or enter the destination MAC address against which the information in the IP header needs to be matched.</p> <p>To select the MAC address of a wireless client that is connected to the wireless access point:</p> <ol style="list-style-type: none"> 1. Select the radio button to the left of the Match Classifications menu. 2. From the menu, select a MAC address. <p>To enter a MAC address:</p> <ol style="list-style-type: none"> 1. Select the radio button to the right of the Match Classifications menu. 2. In the field to the right of the radio button, enter a MAC address.

Setting	Description	
Match Frame Fields and Match Classifications (continued)	Source IP	In the Match Classifications field, enter the source IP address against which the information in the IP header needs to be matched.
	Destination IP	In the Match Classifications field, enter the destination IP address against which the information in the IP header needs to be matched.
	Source Port	The Match Classifications field is separated into two sections. In the left section, enter the source port number, and optionally, in the right section, enter the associated IP address against which the information in the IP header needs to be matched.
	Destination Port	The Match Classifications field is separated into two sections. In the left section, enter the destination port number, and optionally, in the right section, enter the associated IP address against which the information in the IP header needs to be matched.
Apply Classification	From the Apply Classification menu, select the traffic class that needs to be applied to the packets that match the selection in the Match Classifications field: <ul style="list-style-type: none"> • Best Effort(0) • Background(1) • Spare(2) • Excellent(3) • Control Load(4) • Video < 100 ms Latency(5) • Voice < 10 ms Latency(6) • Network Control(7) 	

5. (Optional) Specify rate limiting for the classification as explained in the following table:

Setting	Description	
Classification Rate Limiting	Bits Per Sec.	Enter a value between 0 and 300,000,000 bps to specify the maximum data rate up to which packets that match the classification are queued for transmission and sent immediately over the wireless interface. This value applies only to traffic that matches the classification. Note: When the maximum rate is exceeded, packets are retained in the queue and sent when the transmission falls again below the maximum rate.
	Burst Rate (Bytes)	Enter a value between 0 and 37,500,000 bytes to specify the maximum amount of data that can be transmitted in a burst for packets that match the classification. This value applies only to traffic that matches the classification.

6. Click the **Add** button to add the classification to the Classifications field.
7. To add another classification to the QoS policy, repeat [Step 4](#), [Step 5](#), and [Step 6](#).
8. Click the **Apply** button to save your settings. The QoS policy is saved.

Note: Rate limiting for the wireless interface is an optional setting that applies to all traffic on the wireless interface. Unlike classification rate limiting, which you can specify for each classification, rate limiting for the wireless interface you only must specify once.

➤ **To specify rate limiting for the wireless interface:**

1. Specify rate limiting for the entire wireless interface as explained in the following table:

Setting	Description	
Interface Rate Limiting	Bits Per Sec.	Enter a value between 0 and 300,000,000 bps to specify the maximum data rate up to which packets are queued for transmission and sent immediately over the wireless interface. This value applies to all traffic on the wireless interface. Note: When the maximum rate is exceeded, packets are retained in the queue and sent when the transmission falls again below the maximum rate.
	Burst Rate (Bytes)	Enter a value between 0 and 37,500,000 bytes to specify the maximum amount of data that can be transmitted in a burst over the wireless interface. This value applies to all traffic on the wireless interface.

2. Click the **Apply** button to save your settings.

➤ **To modify a QoS policy:**

1. From the **Create Policy** menu, select the policy that you want to modify.
2. To delete a classification, select it in the Classification field, and click **Delete Classification**.
3. To add a classification, see [Step 4](#) through [Step 6](#) in the procedure to configure a new QoS policy. You can also change the name of the policy.
4. Click the **Apply** button to save your settings.

➤ **To delete a QoS policy:**

1. From the **Create Policy** menu, select the policy that you want to delete.
2. Click the **Delete Policy** button.
3. Click the **Apply** button to save your settings.

Configure Captive Portal

Captive portal allows you to set up a login page so that only users with a valid user name and password may access the internet through the access point. You must first configure the captive portal and add users before enabling it on the access point.

➤ **To configure a captive portal:**

1. Select **Configuration > Captive Portal > Web Customization**.

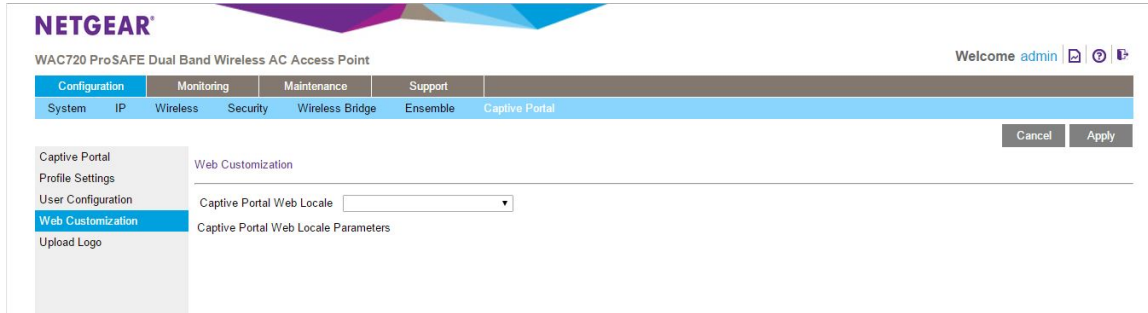

2. Select **Create** from the **Captive Portal Web Locale** menu.
3. Enter a name for the Web Locale in the **Web Local Name** field.
4. Select an instance for the captive portal from the **Captive Portal Instances** menu.

You may edit the look of the captive portal login page using the following fields:

Field	Description
Logo Image Name	This drop down menu displays the names of image files that have been uploaded to the AP for use with a captive portal. Image must be no larger than 5 Kb in size. You can upload logo images on the Upload Logo page.
Browser Title	The browser title appears in the title bar of the browser.
Browser Content	This is the text that will appear on the body of the page.
Content	You can enter instructions for logging into the portal here.
Acceptance Use Policy	Text entered here will display in a user agreement.
Welcome Title	This is the title of the welcome page that displays after the user has successfully logged in.
Welcome Content	This is the content of the welcome page that displays after the user has successfully logged in.

5. Click the **Apply** button to save your changes.

➤ **Add users to a captive portal:**

1. Select **Configuration > Captive Portal > User Configuration**.

2. Enter the name of the user in the **Captive Portal User Name** field.
3. Click the **Apply** button to create the user.
4. Select the user from the user list.
5. Click the **Edit** button.
6. Enter the user's password in the **User Password** field.
7. Enter an away time between zero and 1440 minutes.
The user will be logged out if they are idle longer than the time you enter.
8. Enter the max bandwidth upstream allowed to the user, in megabits per second, in the **Max Bandwidth Upstream** field.
9. Enter the max bandwidth downstream allowed to the user, in megabits per second, in the **Max Bandwidth Downstream** field.
10. Click the **Apply** button to save your changes.

➤ **To enable a captive portal:**

1. Select **Configuration > Captive Portal > Captive Portal**.

2. Select the **Enable** radio button.
3. Click the **Apply** button.
4. Select **Configuration > Security > Profile Settings**.
5. Select the SSID that you want to use captive portal.
6. Click the **Edit** button.
7. In the Captive Portal section, select the profile name of the captive portal you want to enable on this SSID from the drop down menu.
8. Click the **Apply** button.

The captive portal is enabled on the selected SSID.

Configure Wireless Bridging

The wireless access point supports a wireless distributing system (WDS) that lets you build large bridged wireless networks. You can select from the following wireless access point modes:

- **Wireless point-to-point bridge.** In this mode, the wireless access point can communicate with another bridge-mode wireless station and, as an option, also with wireless clients. Use WPA-PSK, or WPA2-PSK to secure the communication. For information about how to configure this mode, see [Configure a Point-to-Point Wireless Network](#) on page 89.
- **Wireless point-to-multipoint bridge.** In this mode, the wireless access point is the master for a group of bridge-mode wireless stations. As an option, the wireless access point can also communicate with wireless clients. You can configure up to four profiles.

The other bridge-mode wireless stations must be set to point-to-point bridge mode, using the MAC address of the master wireless access point. Rather than communicating directly with each other, all other bridge-mode wireless stations send their traffic to the master wireless access point. Use WPA-PSK or WPA2-PSK to secure the communication. For information about how to configure this mode, see [Configure a Point-to-Multipoint Wireless Network](#) on page 92.

- **Repeating the wireless signal.** In this mode, this wireless access point repeats the wireless signal, does not support communication with wireless clients, and sends all traffic to a remote access point. In this mode, wireless clients cannot associate with the wireless access point. Use WPA-PSK or WPA2-PSK to secure the communication. For information about how to configure this mode, see [Configure the Wireless Access Point to Repeat the Wireless Signal Using Point-to-Multipoint Bridge Mode](#) on page 94.

Note: You cannot configure wireless bridging when automatic channel selection is enabled. On the basic Wireless Settings page, make sure that Auto is not selected from the Channel / Frequency menu (see [Configure the Basic Wireless Settings](#) on page 19).

Configure a Point-to-Point Wireless Network

In point-to-point bridge mode, the wireless access point communicates with another bridge-mode wireless station. Use wireless security to protect this communication. The following figure shows an example in which two wireless access points (APs) function in point-to-point bridge mode:

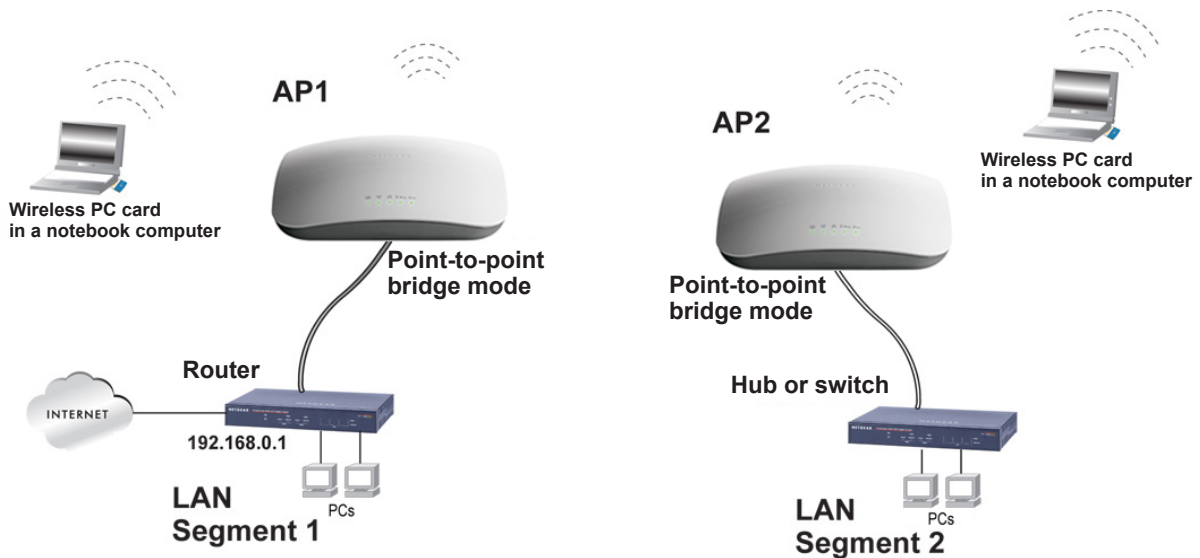
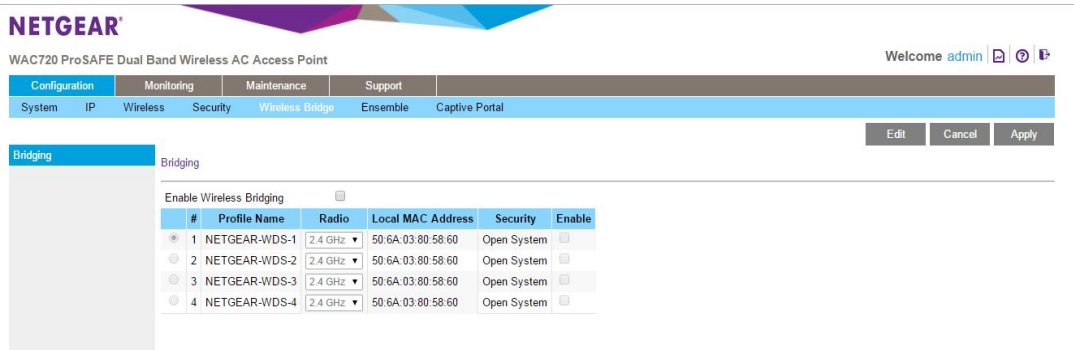

Figure 5.

➤ To configure a point-to-point wireless network:

1. Configure the wireless access point (AP1 on LAN Segment 1 in the previous figure) as a point-to-point bridge:
 - a. Select **Configuration > Wireless Bridge**.



- b. Select the **Enable Wireless Bridging** check box. The Local MAC Address field is a nonconfigurable field that shows the MAC address of the wireless access point.
 - c. Select the **Wireless Point-to-Point Bridge** radio button. The page adjusts.
 - d. If you want to enable wireless client association while the wireless access point functions as a point-to-point bridge, select the **Enable Wireless Client Association** check box.
 - e. Click **Edit** to configure the security profile settings. The Edit Security Profile page displays:

f. Specify the settings as explained in the following table:

Setting	Description	
Profile Definition		
Profile Name	Enter a profile name that is easy to remember. The default name is NETGEAR-WDS-1.	
Remote MAC Address	Enter the MAC address of the remote wireless access point (the MAC address of AP2 on LAN Segment 1 in <i>Figure 5</i> on page 90).	
Authentication Settings		
Network Authentication and Data Encryption	From the Network Authentication menu, select Open System , WPA-PSK , or WPA2-PSK . Your selection determines the options that the Data Encryption menu provides, and whether the WPA Passphrase (Network Key) field displays.	
	WPA-PSK	TKIP (Temporal Key Integrity Protocol) is the standard encryption method used with WPA-PSK and the only selection possible from the Data Encryption menu. In the WPA Passphrase (Network Key) field, enter a passphrase. The passphrase length needs to be between 8 and 63 characters (inclusive).
	WPA2-PSK	AES (Advanced Encryption Standard) is the standard encryption method used with WPA2-PSK and the only selection possible from the Data Encryption menu. In the WPA Passphrase (Network Key) field, enter a passphrase. The passphrase length needs to be between 8 and 63 characters (inclusive). Note: We recommend WPA2-PSK authentication with AES encryption if you want to use the 11n rates and speed.

- g. Click **Apply** to save your security profile settings. The Bridging page displays again.
 - h. If the correct profile name and security option are displayed in the table, select the check box in the Enable column.
 - i. Click **Apply** on the Bridging page to save your point-to-point bridge settings.
2. Configure a second wireless access point (AP2) on LAN Segment 2 (see *Figure 5* on page 90) in point-to-point bridge mode.
AP1 needs to have AP2's MAC address in its Remote MAC Address field, and AP2 needs to have AP1's MAC address in its Remote MAC Address field.
 3. Verify the following settings for both wireless access points:
 - Both wireless access points are configured to operate in the same LAN network address range as the LAN devices.
 - Both wireless access points use the same channel, authentication mode, and security settings.
 4. Verify connectivity across the LAN 1 and LAN 2.

A computer on either LAN segment should be able to connect to the Internet or share files and printers of any other computers or servers connected to LAN Segment 1 or LAN Segment 2.

Configure a Point-to-Multipoint Wireless Network

In a point-to-multipoint bridge, the wireless access point is the master for a group of bridge-mode wireless access points. All traffic is sent to the master rather than to the other wireless access points. Use wireless security to protect this communication.

For each wireless access point that you want the master to be able to connect to, you must configure a security profile with a unique name and the MAC address of the wireless access point. You can configure up to four such security profiles (NETGEAR-WDS-1, NETGEAR-WDS-2, and so on).

The following figure shows an example in which AP1 functions in point-to-multipoint bridge mode and AP2 and AP3 function in point-to-point bridge mode:

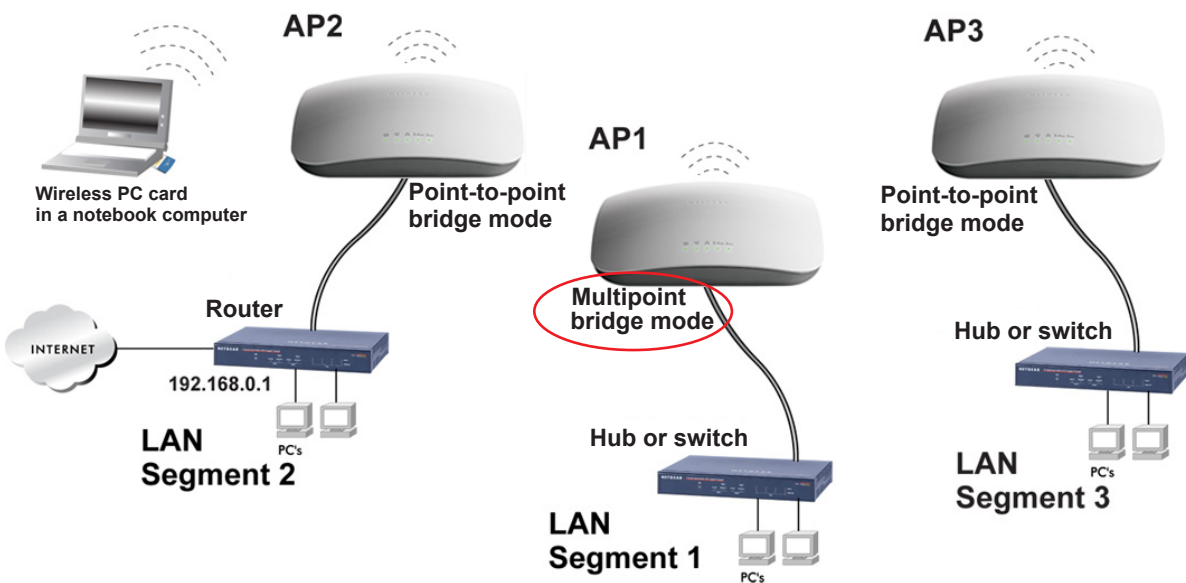

Figure 6.

➤ To configure a point-to-multipoint wireless network:

1. Configure the security profiles on the wireless access point (AP1 on LAN Segment 1 in the previous figure):
 - a. Select **Configuration > Wireless Bridge**. The Bridging page displays. (The following figure shows the page after you have completed [Step c.](#))
 - b. Select the **Enable Wireless Bridging** check box. The Local MAC Address field is a nonconfigurable field that shows the MAC address of the wireless access point.
 - c. Select the **Wireless Point-to-Multi-Point Bridge** radio button. The page adjusts.

- d. The profile table shows four security profiles. Choose a security profile to edit by selecting the corresponding radio button to the left of the profile.
- e. Click **Edit** to configure the selected security profile settings. The Edit Security Profile page displays for the selected security profile. (The following figure contains an example.)
- f. Specify the settings as explained in the following table:

Setting	Description	
Profile Definition		
Profile Name	Enter a profile name that is easy to remember. The default names for the four security profiles are NETGEAR-WDS-1, NETGEAR-WDS-2, NETGEAR-WDS-3, and NETGEAR-WDS-4.	
Remote MAC Address	Enter the MAC address of the remote wireless access point (the MAC address of AP2 or AP 3 on LAN Segment 1 in <i>Figure 6</i> on page 92).	
Authentication Settings		
Network Authentication and Data Encryption	From the Network Authentication menu, select Open System , WPA-PSK , or WPA2-PSK . Your selection determines the options that the Data Encryption menu provides, and whether the WPA Passphrase (Network Key) field displays.	
	WPA-PSK	TKIP (Temporal Key Integrity Protocol) is the standard encryption method used with WPA-PSK and the only selection possible from the Data Encryption menu. In the WPA Passphrase (Network Key) field, enter a passphrase. The passphrase length needs to be between 8 and 63 characters (inclusive).
	WPA2-PSK	AES (Advanced Encryption Standard) is the standard encryption method used with WPA2-PSK and the only selection possible from the Data Encryption menu. In the WPA Passphrase (Network Key) field, enter a passphrase. The passphrase length needs to be between 8 and 63 characters (inclusive). Note: NETGEAR recommends WPA2-PSK authentication with AES encryption if you want to use the 11n rates and speed.

- g. Click **Apply** to save your security profile settings. The Bridging page displays again.
 - h. Repeat *Step b* through *Step g* for any other security profile that you want to edit.
For example, first configure security profile NETGEAR-WDS-1 with the MAC address of AP2, and then configure security profile NETGEAR-WDS-2 with the MAC address of AP3 (see *Figure 6* on page 92).
2. Activate the wireless access point (AP1 on LAN Segment 1 in *Figure 6* on page 92) as a point-to-multipoint bridge (that is, it is the master in the wireless network):
- a. On the Bridging page, select the **Enable Wireless Bridging** check box.

- b. Select the **Wireless Point-to-Multi-Point Bridge** radio button.
- c. Select the **Enable Wireless Client Association** check box to enable wireless client association.

Note: If you do not select the Enable Wireless Client Association check box, the wireless access point does not function in point-to-multipoint bridge but in repeater mode.

- d. If the correct profile names and security options are displayed in the table, select the check boxes in the Enable column for all security profiles that you want to enable.
 - e. Click **Apply** on the Bridging page to activate your point-to-multipoint bridge settings.
3. Configure AP2 on LAN Segment 2 (see *Figure 6* on page 92) in point-to-point bridge mode with the remote MAC address of AP1.
 4. Configure AP3 on LAN Segment 3 (see *Figure 6* on page 92) in point-to-point bridge mode with the remote MAC address of AP1.
 5. Verify the following for all wireless access points:
 - Only AP1 on LAN Segment 1 is configured in point-to-multipoint bridge mode, and all others APs are configured in point-to-point bridge mode.
 - AP2 and AP3 (the point-to-point APs) have AP1's MAC address in their Remote MAC Address field.
 - All APs are on the same LAN, that is, the LAN IP addresses of all APs are in the same network as the LAN devices.
 - All wireless access points use the same channel, authentication mode, and security settings.
 6. Verify connectivity across the LANs:

A computer on any LAN segment should be able to connect to the Internet or share files and printers with any other devices or servers connected to any of the three LAN segments.

Note: You can extend this multipoint bridging configuration by adding additional wireless access points that are configured in point-to-point mode for each additional LAN segment. Furthermore, you can extend the range of the wireless network with NETGEAR wireless antenna accessories.

Configure the Wireless Access Point to Repeat the Wireless Signal Using Point-to-Multipoint Bridge Mode

You can configure the wireless access point to repeat the wireless signal, without communication with other wireless clients. All traffic is sent to the remote or downstream

wireless access point. You can configure up to four security profiles to enable the wireless access point to repeat the wireless signal for four remote wireless access points. Each security profile requires a unique name and needs to include the MAC address of the remote wireless access point. You can configure up to four such security profiles (NETGEAR-WDS-1, NETGEAR-WDS-2, and so on).

The following figure shows an example in which AP1, AP2, and AP3 repeat the wireless signal in point-to-multipoint bridge mode. AP2 requires a security profile for AP1 and another one for AP3:

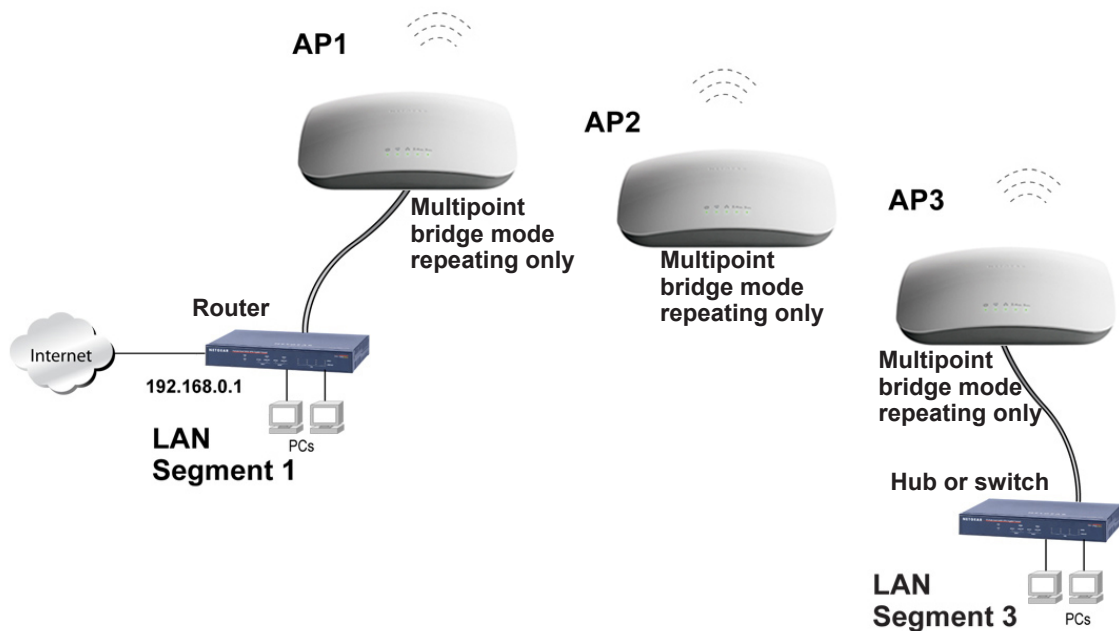

Figure 7.

➤ **To configure the wireless access point to repeat the wireless signal:**

1. Configure the security profiles on the wireless access point (AP2 in the previous figure):
 - a. Select **Configuration > Wireless Bridge**. The Bridging page displays (see the following figure).
 - b. Optional: To display the Bridging page for the 802.11a/na modes, click the **802.11a/na** tab.
 - c. Select the **Enable Wireless Bridging** check box. The Local MAC Address field is a nonconfigurable field that shows the MAC address of the wireless access point.
 - d. Select the **Wireless Point-to-Multi-Point Bridge** radio button. The page adjusts.
 - e. The profile table shows four security profiles. Choose a security profile to edit by selecting the corresponding radio button to the left of the profile.
 - f. Click **Edit** to configure the selected security profile settings. The Edit Security Profile page displays for the selected security profile. (The following figure contains an example.)

- g. Specify the settings as explained in the following table:

Setting	Description	
Profile Definition		
Profile Name	Enter a profile name that is easy to remember. The default names for the four security profiles are NETGEAR-WDS-1, NETGEAR-WDS-2, NETGEAR-WDS-3, and NETGEAR-WDS-4.	
Remote MAC Address	Enter the MAC address of the remote wireless access point (the MAC address of AP1 or AP3 in <i>Figure 7</i> on page 95).	
Authentication Settings		
Network Authentication and Data Encryption	From the Network Authentication menu, select Open System , WPA-PSK , or WPA2-PSK . Your selection determines the options that the Data Encryption menu provides, and whether the WPA Passphrase (Network Key) field displays.	
	WPA-PSK	TKIP (Temporal Key Integrity Protocol) is the standard encryption method used with WPA-PSK and the only selection possible from the Data Encryption menu. In the WPA Passphrase (Network Key) field, enter a passphrase. The passphrase length needs to be between 8 and 63 characters (inclusive).
	WPA2-PSK	AES (Advanced Encryption Standard) is the standard encryption method used with WPA2-PSK and the only selection possible from the Data Encryption menu. In the WPA Passphrase (Network Key) field, enter a passphrase. The passphrase length needs to be between 8 and 63 characters (inclusive). Note: NETGEAR recommends WPA2-PSK authentication with AES encryption if you want to use the 11n rates and speed.

- h. Click **Apply** to save your security profile settings. The Bridging page displays again.
i. Repeat *Step e* through *Step h* for any other security profile that you want to edit.

For example, first configure security profile NETGEAR-WDS-1 with the MAC address of AP1, and then configure security profile NETGEAR-WDS-2 with the MAC address of AP3 (see *Figure 7* on page 95).

2. Activate repeater mode on the wireless access point (AP2 in *Figure 7* on page 95):
- On the Bridging page, select the **Enable Wireless Bridging** check box.
 - Select the **Wireless Point-to-Multi-Point Bridge** radio button.
 - Clear the **Enable Wireless Client Association** check box to disable wireless client association (see the red circle in *Figure e* on page 95).

Note: If you do not clear the Enable Wireless Client Association check box, the wireless access point functions in regular point-to-multipoint bridge mode.

- d. If the correct profile names and security options are displayed in the table, select the check boxes in the Enable column for all security profiles that you want to enable.
 - e. Click **Apply** on the Bridging page to activate your repeater settings.
3. Configure AP1 on LAN Segment 1 (see *Figure 7* on page 95) in repeater mode with the remote MAC address of AP2.
 4. Configure AP3 on LAN Segment 3 (see *Figure 7* on page 95) in repeater mode with the remote MAC address of AP2.
 5. Verify the following for all wireless access points:
 - All APs are on the same LAN, that is, the LAN IP addresses of all APs are in the same network as the LAN devices.
 - All wireless access points use the same channel, authentication mode, and security settings.
 6. Verify connectivity across the LANs:

A computer on any LAN segment should be able to connect to the Internet or share files and printers with any other devices or servers connected to any of the two LAN segments.

Note: You can extend repetition of the wireless signal by adding up to two more wireless access points that are configured in point-to-multipoint bridge mode without client association. Also, you can extend the range of the wireless network with NETGEAR wireless antenna accessories.

Troubleshooting

6

This chapter provides information about troubleshooting the wireless access point. After each problem description, instructions are given to help you diagnose and solve the problem. For the common problems listed, go to the section indicated.

- Is the wireless access point on?
Go to *Basic Functioning* on page 99.
- Have I connected the wireless access point correctly?
Go to *Basic Functioning* on page 99.
- I cannot access the Internet or the LAN.
Go to *You Cannot Access the Internet or the LAN from a Wireless-Capable Computer* on page 101.
- I cannot access the wireless access point from a browser.
Go to *You Cannot Configure the Wireless Access Point from a Browser* on page 101.
- A time-out occurs.
Go to *When You Enter a URL or IP Address a Time-Out Error Occurs* on page 102.
- I have problems with the LAN connection.
Go to *Troubleshoot a TCP/IP Network Using the Ping Utility* on page 102.
- I cannot remember the wireless access point's configuration password.
Go to *Change the Administrator Password* on page 58.
- I want to clear the configuration and start over again.
Go to *Restore the Wireless Access Point to the Factory Default Settings* on page 56.
- The date or time is not correct.
Go to *Problems with Date and Time* on page 104.

The wireless access point provides a packet capture tool that enables you to perform problem diagnoses. For information about how to use this tool, see *Use the Packet Capture Tool* on page 105.

Basic Functioning

- *Verify the Correct Sequence of Events at Start Up*
- *No LEDs Are Lit on the Wireless Access Point*
- *The Active LED or the LAN LED Is Not Lit*
- *The WLAN LED Does Not Light Up*

Note: For descriptions of the LEDs, see *Top Panel* on page 7.

Verify the Correct Sequence of Events at Start Up

- **After you turn on power to the wireless access point, check that the following sequence of events occurs:**
 - The Power/Test LED is first steady amber, then goes off, and then blinks green before turning steady green after about 45 seconds.
 - The Active LED is lit or blinks green when there is Ethernet traffic.
 - The LAN LED indicates the LAN speed: green for 1000 Mbps, amber for 100 Mbps, and no light for 10 Mbps.
 - The WLAN LED is lit or blinks green when the wireless LAN (WLAN) is ready.

If any of these conditions does not occur, see to the appropriate following section.

No LEDs Are Lit on the Wireless Access Point

It takes a few seconds for the Power LED to light up. Wait a minute and check the Power LED status on the wireless access point. If the wireless access point has no power:

- **If you use one or more PoE switches to provide power to the wireless access point, check these items:**
 - Make sure that the Ethernet cables between the wireless access point and the PoE switches are correctly connected at both ends.
 - Make sure that the power cords of the PoE switches are plugged into working power outlets or power strips.
 - Make sure that the PoE switches are functioning normally.

- **If you use a power cord to provide power to the wireless access point, check these items:**
- Make sure that the power cord is connected to the wireless access point.
 - Make sure that the power adapter is connected to a functioning power outlet. If it is in a power strip, make sure that the power strip is turned on. If it is plugged directly into the wall, verify that it is not a switched outlet.
 - Make sure that you are using the correct NETGEAR power adapter that is supplied with your wireless access point.

The Active LED or the LAN LED Is Not Lit

There is a hardware connection problem.

- **Check these items:**
- Make sure that the cable connectors are securely plugged in at the wireless access point and the network device—hub, (PoE) switches, or router.
 - Make sure that the connected device is turned on.
 - Make sure that the correct cable is used. Use a standard Category 5 Ethernet patch cable. If the network device has Auto Uplink (MDI/MDIX) ports, you can use either a crossover cable or a normal patch cable.

The WLAN LED Does Not Light Up

The wireless access point's antenna is not working.

- **Check these items:**
- If the WLAN LED remains off, either disconnect the cables to the PoE switches and then reconnect them again, or disconnect the adapter from its power source and then plug it in again.
 - Make sure that optional external antennas are tightly connected to the wireless access point.

Contact NETGEAR technical support if the WLAN LED remains off.

You Cannot Access the Internet or the LAN from a Wireless-Capable Computer

There is a configuration problem.

➤ **Check these items:**

- You might not have restarted the computer with the wireless adapter to allow TCP/IP changes take effect. Restart the computer.
- The computer with the wireless adapter might not have the correct TCP/IP settings to communicate with the network. Restart the computer and check that TCP/IP is set up correctly for that network. In Windows, the usual setting for Network Properties is to obtain an IP address automatically.
- The wireless access point's default values might not work with your network. Check the wireless access point's default configuration against the configuration of other devices in your network.
- Make sure that the SSID, network authentication, and data encryption settings of the computer with the wireless adapter are the same as those of the wireless access point.
- Ping the IP address of the wireless access point to verify that there is a wireless connection between the computer with the wireless adapter and the wireless access point. If the ping fails, check the network configuration (for the wireless access point, see [Configure the IPv4 Settings](#) on page 18).
- Ping the default gateway to verify that there is a path from the computer with the wireless adapter to the default gateway. If the ping fails, check the network configuration or call the Internet service provider (ISP).

You Cannot Configure the Wireless Access Point from a Browser

➤ **Check these items:**

- The wireless access point is correctly installed, it is powered on, and LAN connections are okay. Check that the Active LED and LAN LED are on to verify that the Ethernet connection is okay.
- If your computer uses a fixed (static) IP address, ensure that it is using an IP address in the range of the wireless access point. The wireless access point's default IP address is 192.168.0.100, and its subnet mask is 255.255.255.0 with DHCP disabled. Make sure that your network configuration settings are correct.
- If you are using the NetBIOS name of the wireless access point to connect, ensure that your computer and the wireless access point are on the same network segment or that there is a WINS server on your network.
- If your computer is set to obtain an IP address automatically (DHCP client), restart it.

- Make sure that your browser has Java, JavaScript, or ActiveX enabled. If you are using Internet Explorer, click **Refresh** to be sure that the Java applet is loaded.
 - Try quitting the browser, clearing the cache, deleting the cookies, and launching the browser again.
 - Make sure that you are using the correct login information. The factory default login name is **admin**, and the password is **password**. Make sure that Caps Lock is off when entering this information.
- **If the wireless access point does not save changes you have made in the web management interface, check the following:**
- When entering configuration settings, be sure to click the **Apply** button before moving to another page or tab, or your changes are lost.
 - Click the **Refresh** or **Reload** button in the web browser. The changes might have occurred, but the web browser might be caching the old configuration.

When You Enter a URL or IP Address a Time-Out Error Occurs

A number of things could be causing this.

- **Try the following troubleshooting steps:**
- Check whether other computers on the LAN work correctly. If they do, ensure that your computer's TCP/IP settings are correct. If you use a fixed (static) IP address, check the subnet mask, default gateway, DNS, and IP addresses of the wireless access point (see [Configure the IPv4 Settings](#) on page 18).
 - If the computer is configured correctly but still not working, ensure that the wireless access point is connected and turned on. Access it and check its settings. If you cannot connect to the wireless access point, check the LAN and power connections.
 - If the wireless access point is configured correctly, check your Internet connection (for example, your cable modem) to make sure that it is working correctly.

Troubleshoot a TCP/IP Network Using the Ping Utility

- [Test the LAN Path to Your Wireless Access Point](#)
- [Test the Path from Your Computer to a Remote Device](#)

Most TCP/IP terminal devices and routers contain a ping utility that sends an echo request packet to the designated device. The device then responds with an echo reply. You can easily troubleshoot a TCP/IP network by using the ping utility in your computer.

Test the LAN Path to Your Wireless Access Point

You can ping the wireless access point from your computer to verify that the LAN path to your wireless access point is set up correctly.

➤ **To ping the wireless access point from a computer running Windows 95 or later:**

1. From the Windows toolbar, click the **Start** button, and select **Run**.
2. In the field provided, type `ping` followed by the IP address of the wireless access point, as in this example:

```
ping 192.168.0.100
```

3. Click **OK**.

You should see a message like this one:

```
Pinging <IP address> with 32 bytes of data
```

If the path is working, you see this message:

```
Reply from < IP address >: bytes=32 time=NN ms TTL=xxx
```

If the path is not working, you see this message:

```
Request timed out
```

If the path is not functioning correctly, you could have one of the following problems:

- Wrong physical connections:
 - Make sure that the Active LED and LAN LED are on. If one or both of these LEDs are off, follow the instructions in *The Active LED or the LAN LED Is Not Lit* on page 100.
 - Check that the corresponding link LEDs are on for your network interface card and for the hub ports (if any) that are connected to your workstation and wireless access point.
- Wrong network configuration:
 - Verify that the Ethernet card driver software and TCP/IP software are both installed and configured on your computer.
 - Verify that the IP address for your wireless access point and your workstation are correct and that the addresses are on the same subnet.

Test the Path from Your Computer to a Remote Device

After verifying that the LAN path works correctly, test the path from your computer to a remote device.

1. From the Windows toolbar, click the **Start** button, and select **Run**.
2. In the Windows Run window, type:

```
ping -n 10 <IP address>
```

where *<IP address>* is the IP address of a remote device such as the DNS server of your ISP.

If the path is functioning correctly, replies as in the previous section display. If you do not receive replies:

- Check that your computer has the IP address of your router listed as the default wireless access point. If the IP configuration of your computer is assigned by DHCP, this information is not visible in your computer's Network Control Panel. Verify that the IP address of the router is listed as the default wireless access point.
- Check to see that the network address of your computer (the portion of the IP address specified by the netmask) is different from the network address of the remote device.
- Check that your cable or DSL modem is connected and functioning.
- If your ISP assigned a host name to your computer, enter that host name as the account name in the basic General system settings page (see *Configure Basic General System Settings and Time Settings* on page 16).

Problems with Date and Time

The Time Settings page that is accessible through the Configuration > System > Basic > Time menu choices displays the current date and time of day. The wireless access point uses the Network Time Protocol (NTP) to obtain the current time from a network time server on the Internet that you specify in the Time Settings page (see *Configure Basic General System Settings and Time Settings* on page 16). Each entry on the Logs page is stamped with the date and time of day. Problems with the date and time function can include the following:

- Date and time shown is Fri Dec 31 00:00:00 1999 or a similar incorrect date and time. Cause: The wireless access point has not yet successfully reached the network time server. Check that your Internet access settings are configured correctly. If you have just completed configuring the wireless access point, wait at least 5 minutes and check the date and time again.
- The day is correct or one day ahead or behind, and the hours are ahead or behind. Cause: You have selected an incorrect time zone for your area. Specify the correct time zone in the basic General system settings page (see *Configure Basic General System Settings and Time Settings* on page 16).

Use the Packet Capture Tool

You can capture wireless packets to analyze traffic patterns with a network traffic analyzer tool. The captured packet flow can show if traffic is flowing correctly to its destinations or if packets are dropped. There is a limit to the size of the packet flow that you can capture in a file.

➤ **To capture packets:**

1. Select **Monitoring > Packet Capture**. The Packet Capture page displays:

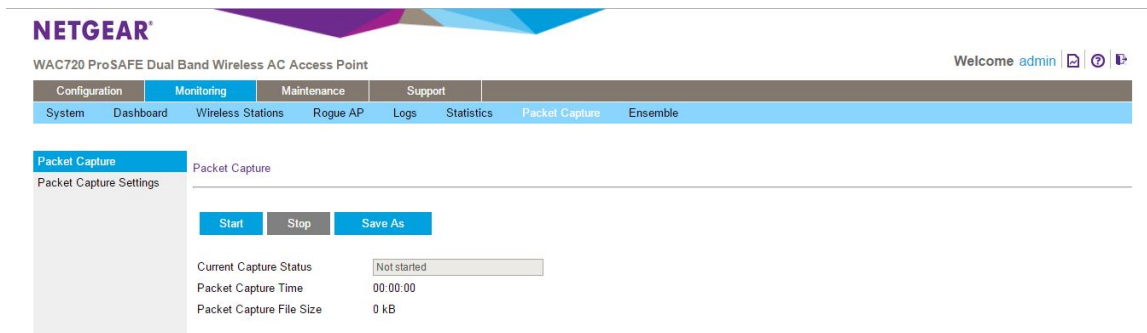

Figure 8.

2. Click **Start** to start capturing wireless packets leaving or entering the wireless access point on the active operating channel. Packets on the 2.4 GHz interface and 5 GHz interface are captured. Normal functioning of the wireless access point is not affected during the packet capture process.

If any previously captured packets exist, you are prompted to delete them, and only then can you capture new packets.

3. Click **Stop** to stop capturing packets.
4. Click **Save as** to save the papture.pcap file on your computer or to a disk drive.

A Supplemental Information

A

This appendix provides factory default settings and technical specifications for the ProSAFE Dual-Band Wireless AC Access Point WAC720 WAC730. The appendix includes the following sections:

- *Technical Specifications*
- *Factory Default Settings*

Technical Specifications

Table 2. Technical specifications

Feature	Description
802.11bg/ng/bgn wireless specifications	
802.11b data rates	1, 2, 5.5, and 11 Mbps, and auto-rate capable
802.11g data rates	1, 2, 5.5, 6, 9, 11, 12, 18, 24, 36, 48, 54 Mbps, and auto-rate capable
802.11bgn MCS index and data rates	Data rates for a 20 MHz channel width and an automatic guard interval: 0 / 7.2 Mbps, 1 / 14.4 Mbps, 2 / 21.7 Mbps, 3 / 28.9 Mbps, 4 / 43.3 Mbps, 5 / 57.8 Mbps, 6 / 65 Mbps, 7 / 72.2 Mbps, 8 / 14.44 Mbps, 9 / 28.88 Mbps, 10 / 43.33 Mbps, 11 / 57.77 Mbps, 12 / 86.66 Mbps, 13 / 115.56 Mbps, 14 / 130 Mbps, 15 / 144.44 Mbps, 16 / 21.7 Mbps, 17 / 43.3 Mbps, 18 / 65 Mbps, 19 / 86.7 Mbps, 20 / 130.7 Mbps, 21 / 173.3 Mbps, 22 / 195 Mbps, 23 / 216.7 Mbps, and auto-rate capable
	Data rates for a 20 MHz channel width and a long guard interval (800 ms): 0 / 6.5 Mbps, 1 / 13 Mbps, 2 / 19.5 Mbps, 3 / 26 Mbps, 4 / 39 Mbps, 5 / 52 Mbps, 6 / 58.5 Mbps, 7 / 65 Mbps, 8 / 13 Mbps, 9 / 26 Mbps, 10 / 39 Mbps, 11 / 52 Mbps, 12 / 78 Mbps, 13 / 104 Mbps, 14 / 117 Mbps, 15 / 130 Mbps, 16 / 19.5 Mbps, 17 / 39 Mbps, 18 / 58.5 Mbps, 19 / 78 Mbps, 20 / 117 Mbps, 21 / 156 Mbps, 22 / 175.5 Mbps, 23 / 195 Mbps, and auto-rate capable
	Data rates for a 40 MHz channel width and an automatic guard interval: 0 / 15 Mbps, 1 / 30 Mbps, 2 / 45 Mbps, 3 / 60 Mbps, 4 / 90 Mbps, 5 / 120 Mbps, 6 / 135 Mbps, 7 / 150 Mbps, 8 / 30 Mbps, 9 / 60 Mbps, 10 / 90 Mbps, 11 / 120 Mbps, 12 / 180 Mbps, 13 / 240 Mbps, 14 / 270 Mbps, 15 / 300 Mbps, 16 / 45 Mbps, 17 / 90 Mbps, 18 / 135 Mbps, 19 / 180 Mbps, 20 / 270 Mbps, 21 / 360 Mbps, 22 / 405 Mbps, 23 / 450 Mbps, and auto-rate capable
802.11bgn MCS index and data rates (continued)	Data rates for a 40 MHz channel width and a long guard interval (800 ms): 0 / 13.5 Mbps, 1 / 27 Mbps, 2 / 40.5 Mbps, 3 / 54 Mbps, 4 / 81 Mbps, 5 / 108 Mbps, 6 / 121.5 Mbps, 7 / 135 Mbps, 8 / 27 Mbps, 9 / 54 Mbps, 10 / 81 Mbps, 11 / 108 Mbps, 12 / 162 Mbps, 13 / 216 Mbps, 14 / 243 Mbps, 15 / 270 Mbps, 16 / 40.5 Mbps, 17 / 81 Mbps, 18 / 121.5 Mbps, 19 / 162 Mbps, 20 / 243 Mbps, 21 / 324 Mbps, 22 / 364.5 Mbps, 23 / 405 Mbps, and auto-rate capable
802.11bg/ng/bgn operating frequencies	<ul style="list-style-type: none"> • 2.412–2.462 GHz (US) • 2.457–2.462 GHz (Spain) • 2.410–2.484 GHz (Japan 11b) • 2.410–2.472 GHz (Japan 11ng) • 2.457–2.472 GHz (France) • 2.412–2.472 GHz (Europe ETSI) • 2.412–2.472 GHz (China)
802.11 bg/ng/bgn encryption	<ul style="list-style-type: none"> • WPA-PSK & WPA2-PSK • AES • TKIP
802.11a/a-na-ac wireless specifications	

Table 2. Technical specifications (continued)

Feature	Description
802.11a data rates	6, 9, 12, 18, 24, 36, 48, 54 Mbps, and auto-rate capable
802.11a/a-na-ac data rates	Data rates for a 20 MHz channel width and an automatic guard interval: 0 / 7.2 Mbps, 1 / 14.4 Mbps, 2 / 21.7 Mbps, 3 / 28.9 Mbps, 4 / 43.3 Mbps, 5 / 57.8 Mbps, 6 / 65 Mbps, 7 / 72.2 Mbps, 8 / 14.44 Mbps, 9 / 28.88 Mbps, 10 / 43.33 Mbps, 11 / 57.77 Mbps, 12 / 86.66 Mbps, 13 / 115.56 Mbps, 14 / 130 Mbps, 15 / 144.44 Mbps, 16 / 21.7 Mbps, 17 / 43.3 Mbps, 18 / 65 Mbps, 19 / 86.7 Mbps, 20 / 130.7 Mbps, 21 / 173.3 Mbps, 22 / 195 Mbps, 23 / 216.7 Mbps, and auto-rate capable
	Data rates for a 20 MHz channel width and a long guard interval (800 ms): 0 / 6.5 Mbps, 1 / 13 Mbps, 2 / 19.5 Mbps, 3 / 26 Mbps, 4 / 39 Mbps, 5 / 52 Mbps, 6 / 58.5 Mbps, 7 / 65 Mbps, 8 / 13 Mbps, 9 / 26 Mbps, 10 / 39 Mbps, 11 / 52 Mbps, 12 / 78 Mbps, 13 / 104 Mbps, 14 / 117 Mbps, 15 / 130 Mbps, 16 / 19.5 Mbps, 17 / 39 Mbps, 18 / 58.5 Mbps, 19 / 78 Mbps, 20 / 117 Mbps, 21 / 156 Mbps, 22 / 175.5 Mbps, 23 / 195 Mbps, and auto-rate capable
	Data rates for a 40 MHz channel width and an automatic guard interval: 0 / 15 Mbps, 1 / 30 Mbps, 2 / 45 Mbps, 3 / 60 Mbps, 4 / 90 Mbps, 5 / 120 Mbps, 6 / 135 Mbps, 7 / 150 Mbps, 8 / 30 Mbps, 9 / 60 Mbps, 10 / 90 Mbps, 11 / 120 Mbps, 12 / 180 Mbps, 13 / 240 Mbps, 14 / 270 Mbps, 15 / 300 Mbps, 16 / 45 Mbps, 17 / 90 Mbps, 18 / 135 Mbps, 19 / 180 Mbps, 20 / 270 Mbps, 21 / 360 Mbps, 22 / 405 Mbps, 23 / 450 Mbps, and auto-rate capable
	Data rates for a 40 MHz channel width and a long guard interval (800 ms): 0 / 13.5 Mbps, 1 / 27 Mbps, 2 / 40.5 Mbps, 3 / 54 Mbps, 4 / 81 Mbps, 5 / 108 Mbps, 6 / 121.5 Mbps, 7 / 135 Mbps, 8 / 27 Mbps, 9 / 54 Mbps, 10 / 81 Mbps, 11 / 108 Mbps, 12 / 162 Mbps, 13 / 216 Mbps, 14 / 243 Mbps, 15 / 270 Mbps, 16 / 40.5 Mbps, 17 / 81 Mbps, 18 / 121.5 Mbps, 19 / 162 Mbps, 20 / 243 Mbps, 21 / 324 Mbps, 22 / 364.5 Mbps, 23 / 405 Mbps, and auto-rate capable
802.11a/a-na operating frequencies	<ul style="list-style-type: none"> • 5.180–5.240 GHz (US, lower frequencies) • 5.260–5.320 GHz (US, middle frequencies) • 5.180–5.240 GHz (CE [EU], lower frequencies) • 5.260–5.320 GHz (CE [EU], middle frequencies) • 5.500–5.680 GHz (CE [EU], upper frequencies)
802.11 a/a-na encryption	<ul style="list-style-type: none"> • WPA-PSK & WPA2-PSK • AES • TKIP
Management and Other Specifications	
Network management	<ul style="list-style-type: none"> • Remote configuration and management through the web management interface, through SNMP, or through Telnet or SSH with the command-line interface (CLI). • SNMP management supports SNMP MIB II, 802.11 MIB and proprietary configuration MIB.
Maximum clients	Limited by the amount of wireless network traffic generated by each node; a maximum of 400 clients is supported.

Table 2. Technical specifications (continued)

Feature	Description
Status LEDs	<ul style="list-style-type: none"> • Power/Test LED • Activity LED • Ethernet LAN • Wireless LAN (2.4 GHz and 5 GHz)
Electrical and Physical Specifications	
Power adapter	12 VDC, 2.5A; plug is localized to country of sale
Physical specifications	<ul style="list-style-type: none"> • Dimensions (h x w x d): 197.3 x 197.3 x 40mm (7.76 x 7.76 x 1.57 in.) • Weight: 762 g (1.6 lb)
Environmental specifications	Operating temperature: 0 to 40°C (32 to 131°F) Operating humidity: 10–90%, noncondensing
Electromagnetic compliance	<ul style="list-style-type: none"> • FCC Part 15 SubPart B • FCC Part 15 SubPart C • FCC Part 15 SubPart E • CE • C-TICK

Factory Default Settings

You can use the Reset button located on the rear of the wireless access point to reset all settings to their factory defaults. This is called a hard reset.

To perform a hard reset, use a sharp object to press and hold the **Reset** button for approximately 5 seconds (until the Test LED blinks rapidly). This returns the wireless access point to the factory configuration settings that are shown in the following table.

Note: Pressing the Reset button for a shorter period of time simply causes the wireless access point to reboot.

Table 3. Default configuration settings

Feature	Description
Login for management and configuration	
LAN IPv4 management address	192.168.0.100
Subnet mask for IPv4 management address	255.255.255.0
LAN IPv6 management address	2001::21c:c0ff:fe69
User name (case-sensitive) for login	admin
Login password (case-sensitive) for login	password
LAN and management features	
DHCPv4 client	Enabled
DHCPv6 client	Disabled
Untagged VLAN	Enabled, VLAN ID 1
Management VLAN	VLAN ID 1
SNMP	Enabled
Syslog	Disabled
Spanning Tree Protocol (STP)	Disabled
Link Layer Discovery Protocol (LLDP)	Enabled
Secure Shell (SSH)	Enabled
Telnet	Disabled

Table 3. Default configuration settings (continued)

Feature	Description
Time zone	USA-Pacific
NTP client	Enabled
Custom NTP server	Disabled
Port speed	10/100/1000
Ethernet MAC address	See bottom label
Radio and wireless settings	
Operating mode	Access point, infrastructure mode
Wireless access point name	netgearxxxxxx, where xxxxxx are the last 6 digits of the wireless access point MAC address
Country and region	Varies by region
Wireless communication	2.4 GHz radio enabled 5 GHz radio enabled
Wireless modes	11bg/ng/bgn 11a/a-na-ac
Wireless network names (SSIDs)	NETGEAR_11ng NETGEAR_11ac
Broadcast network names (SSIDs)	Enabled
Radio frequency channels	11ng: Auto 11ac: Auto
MCS index/data rate (transmission speed)	Best Note: Maximum wireless signal rate derived from IEEE Standard 802.11 specifications. Actual throughput will vary. Network conditions and environmental factors, including volume of network traffic, building materials and construction, and network overhead, lower actual data throughput rate.
Channel width	11ng: 20 MHz 11ac: Dynamic 20/40 MHz
Guard interval	Auto
Output power	Full
Wireless on/off (radio scheduling)	Disabled
RTS threshold	2347
Fragmentation length	2346

Table 3. Default configuration settings (continued)

Feature	Description	
	Beacon interval	100
	Aggregation length	65535
	A-MPDU	Enabled
	RIFS transmission	Disabled
	DTIM interval	3
	Preamble type	Auto
	Antenna	Internal
	802.11d	Enabled
	Maximum wireless clients	400
	Wi-Fi Multimedia (WMM)	Enabled
	WMM powersave	Enabled
	AP EDCA parameters (QoS settings)	See Configure Quality of Service Policies on page 81.
	Station EDCA parameters (QoS settings)	
	QoS policies	None
	Wireless bridging	Disabled
Default wireless profile and profile security		
	Profile name	NETGEAR
	Profile state	Enabled
	Wireless network names (SSIDs)	NETGEAR_11ng NETGEAR_11ac
	Broadcast wireless network names (SSIDs)	Enabled
	Network authentication	Open system (no authentication)
	Data encryption	None
	Wireless client security separation	Disabled
	VLAN ID	1

Table 3. Default configuration settings (continued)

Feature	Description
Wireless security features	
Rogue AP detection	Disabled
Rogue AP detection policy	Moderate
MAC authentication	Disabled
RADIUS servers	None
RADIUS authentication port number	1812
RADIUS shared secret	sharedsecret
RADIUS accounting port number	1813
RADIUS reauthentication time	3600 seconds
RADIUS update of the global key	1800 seconds