

LOGITECH ZONE WIRED EARBUDS

Setup Guide
Guide d'installation

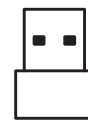
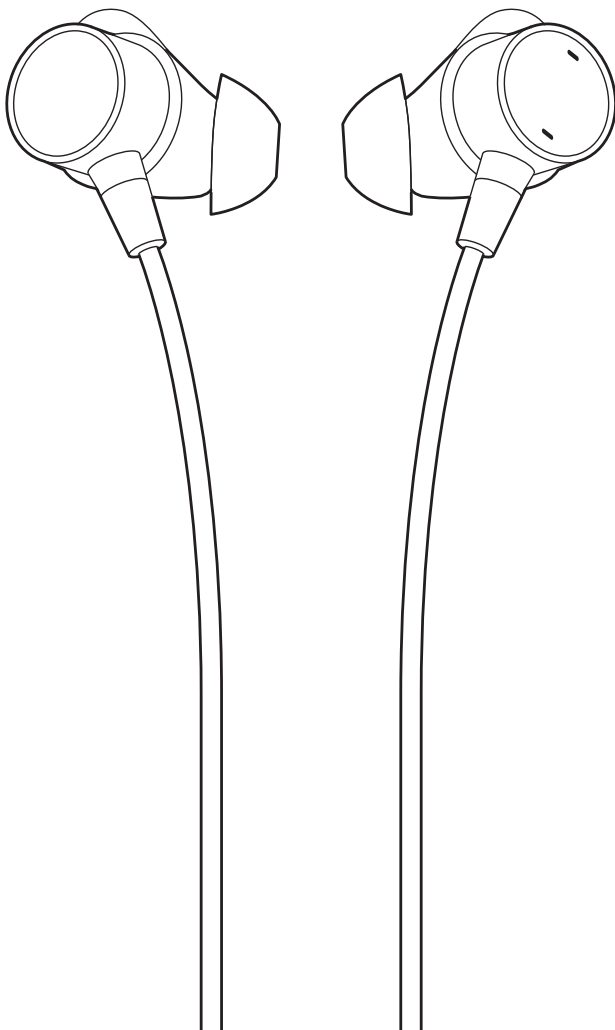

UNIFIED COMMUNICATIONS
(UC) VERSION

VERSION COMMUNICATIONS
UNIFIÉES (UC)

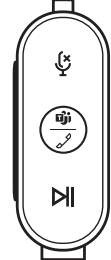
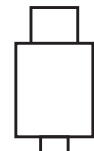
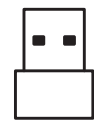

MICROSOFT
TEAMS VERSION

VERSION MICROSOFT
TEAMS

CONTENTS

English3

Français 11

Español. 19

Português 27

KNOW YOUR PRODUCT

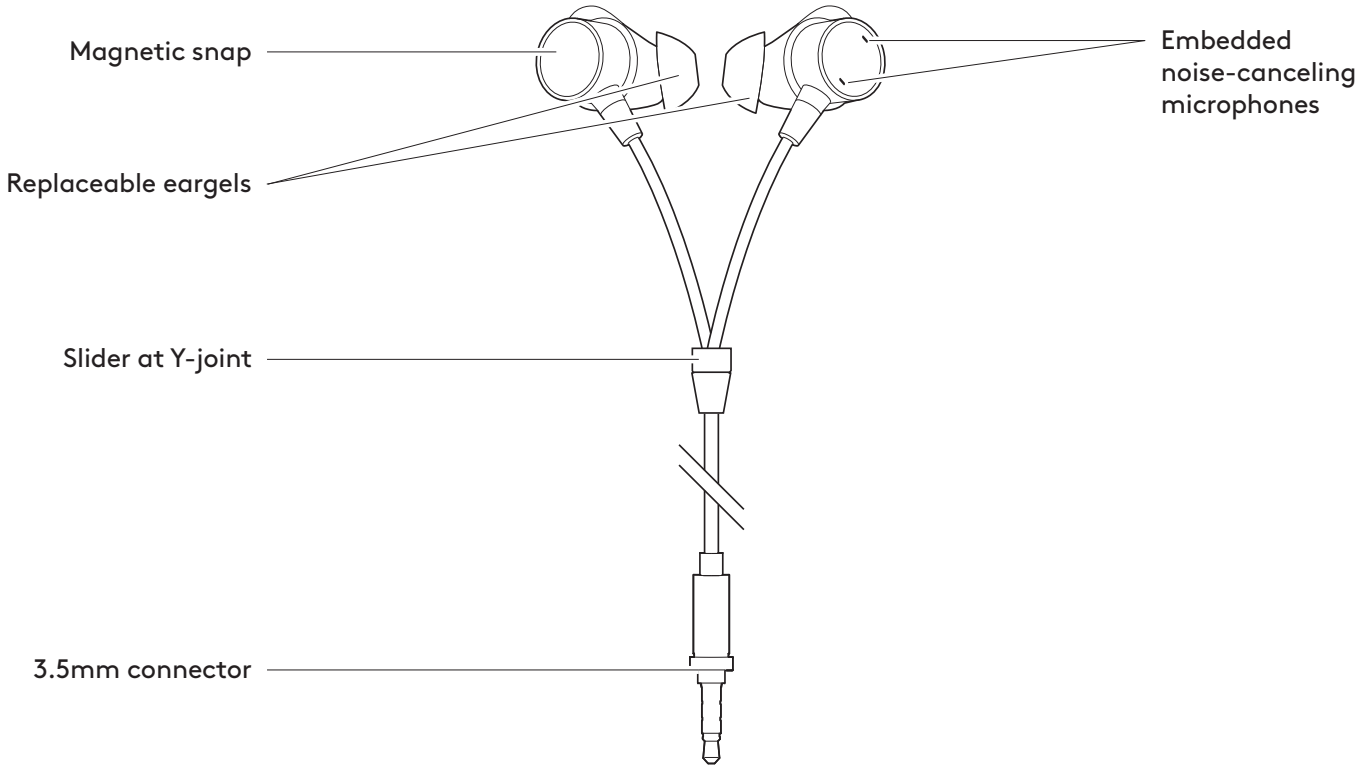

IN-LINE CONTROLLER

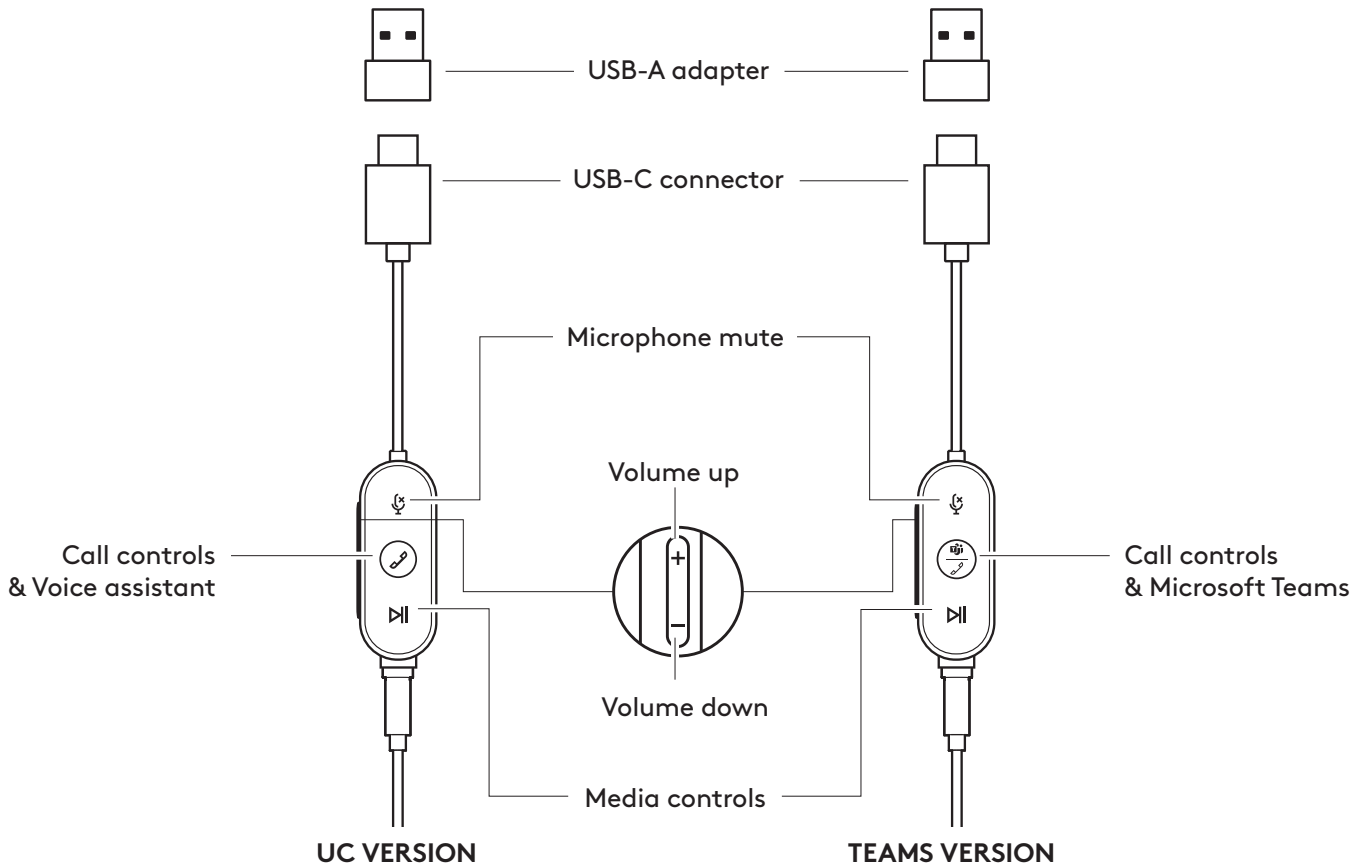

WHAT'S IN THE BOX

1. Wired earbuds with M size eargels and 3.5mm connector
2. In-line controller with USB-C connector
3. USB-A adapter
4. Travel bag
5. Replaceable eargels (1 pair per XS/S/L size)
6. User documentation

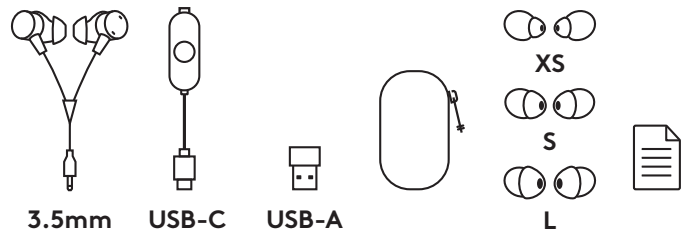

CONNECTING THE EARBUD

Connect via 3.5mm

1. Unplug 3.5mm connector from the in-line controller.
2. Plug the 3.5mm connector into your mobile or tablet 3.5mm port.

Note: Compatibility may depend on device models.
Mic and audio quality will convert to analog with 3.5mm connector.

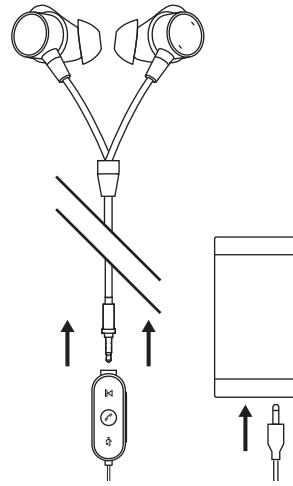

Connect via USB-C

1. Plug the 3.5mm connector into the controller.*
2. Then plug the USB-C connector into your computer USB-C port.

Note: Compatibility may depend on device models.

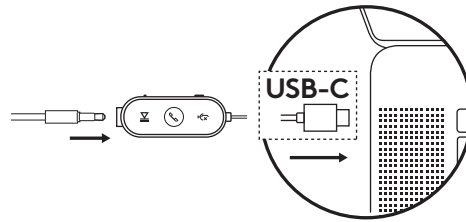

Connect via USB-A

1. Plug the 3.5mm connector to the controller.*
2. Plug the USB-C connector into the USB-A adapter.
3. Plug the USB-A connector into your computer USB-A port.

Note: Only use the USB-A adapter with the provided earbuds.

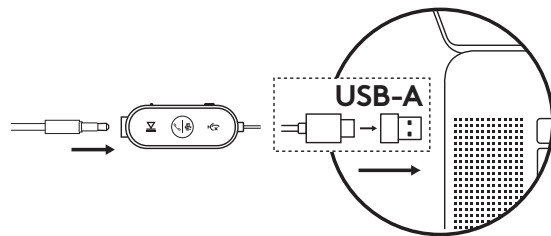

*Make sure 3.5mm connector is fully inserted into the controller.

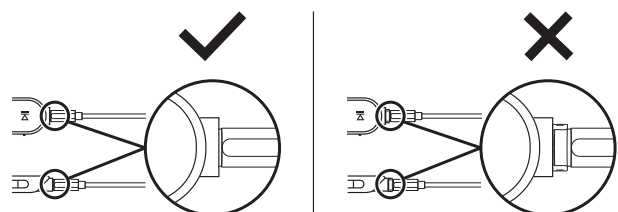

EARBUD FIT

1. Earbuds are marked 'L' and 'R' for the left and right ear. Earbuds are fitted with medium size eargels out of the box.

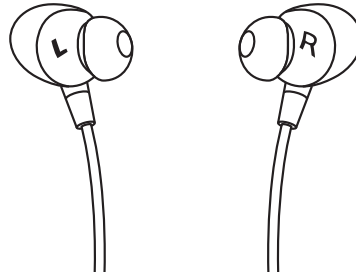

2. Slightly move the earbud around to be securely positioned in your ear.

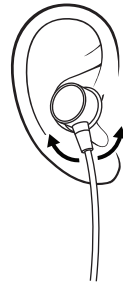

If your earbuds are not comfortable, change to alternative sized eargels. See next section for the replacement steps.

- Try a small size if you feel too much pressure on your ear, or large size if the earbuds are too loose.
- Note that you may use different sized eargels in each ear as your ears may not be the same size.

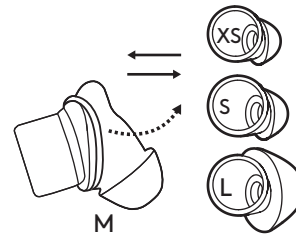

3. Move the slider at the Y-joint up and down to adjust the cable length.

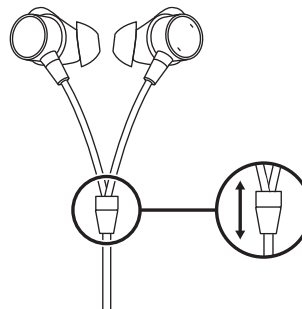

REPLACING THE EARGEL

1. Hold the body of the earbud with one hand.
2. With the other hand, gently pull the whole eargel away from the body of the earbud.

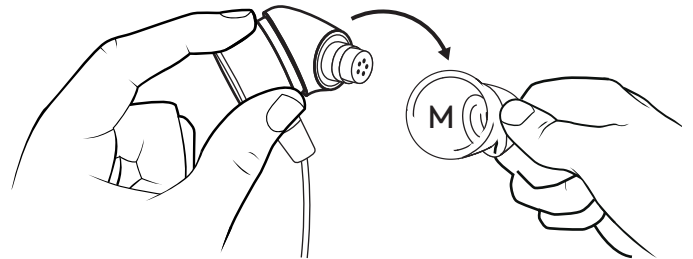
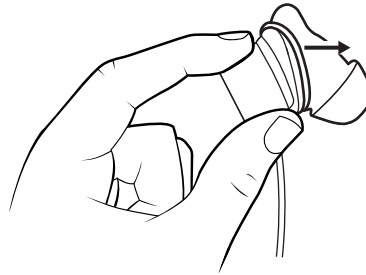



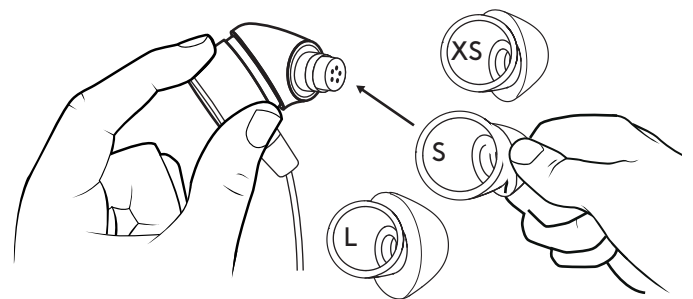

3. Grab alternative sized eargels. Please find the size inside the eargel.

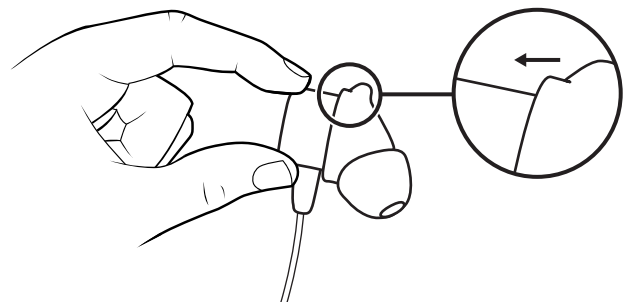

4. Gently stretch the eargel onto the earbud, until there is no gap between eargel and body of the earbud.





HEADSET IN-LINE CONTROLS AND INDICATOR LIGHT

| TEAMS version | | | | |
|--|-------------------------|---|---|--|
| Button | Usage | Indicator Light | Action | |
|  | Mute | Mute on | Solid RED | Short press to mute / unmute |
| | | Mute off | No light | |
|   | Call Controls | Incoming calls | Flashing WHITE | Short press to answer calls |
| | | Ongoing calls | Solid WHITE | 2 seconds press to reject calls |
| | Teams Activities | Connecting to Teams | Pulsing PURPLE | Short press to check connection to Teams |
| | | Failed connection to Teams | Flashing PURPLE for 10 secs then off | |
| | | Not connected to Teams | Flashing PURPLE 3 times then off | |
| | | Connected to Teams | Solid PURPLE | Short press to quickly access Teams |
| Teams Missed call / Voice mail / Join meeting notifications | Pulsing PURPLE | 2 seconds press to trigger Teams voice skills (Cortana) | Short press to Respond to Teams notifications | |
|  | Media Controls | No light | Short press to play / pause | |
| | | | Double press to track forward | |
| | | | Triple press to track backward | |
| + - | Volume | No light | Short press to volume up | |
| | | | Short press to volume down | |

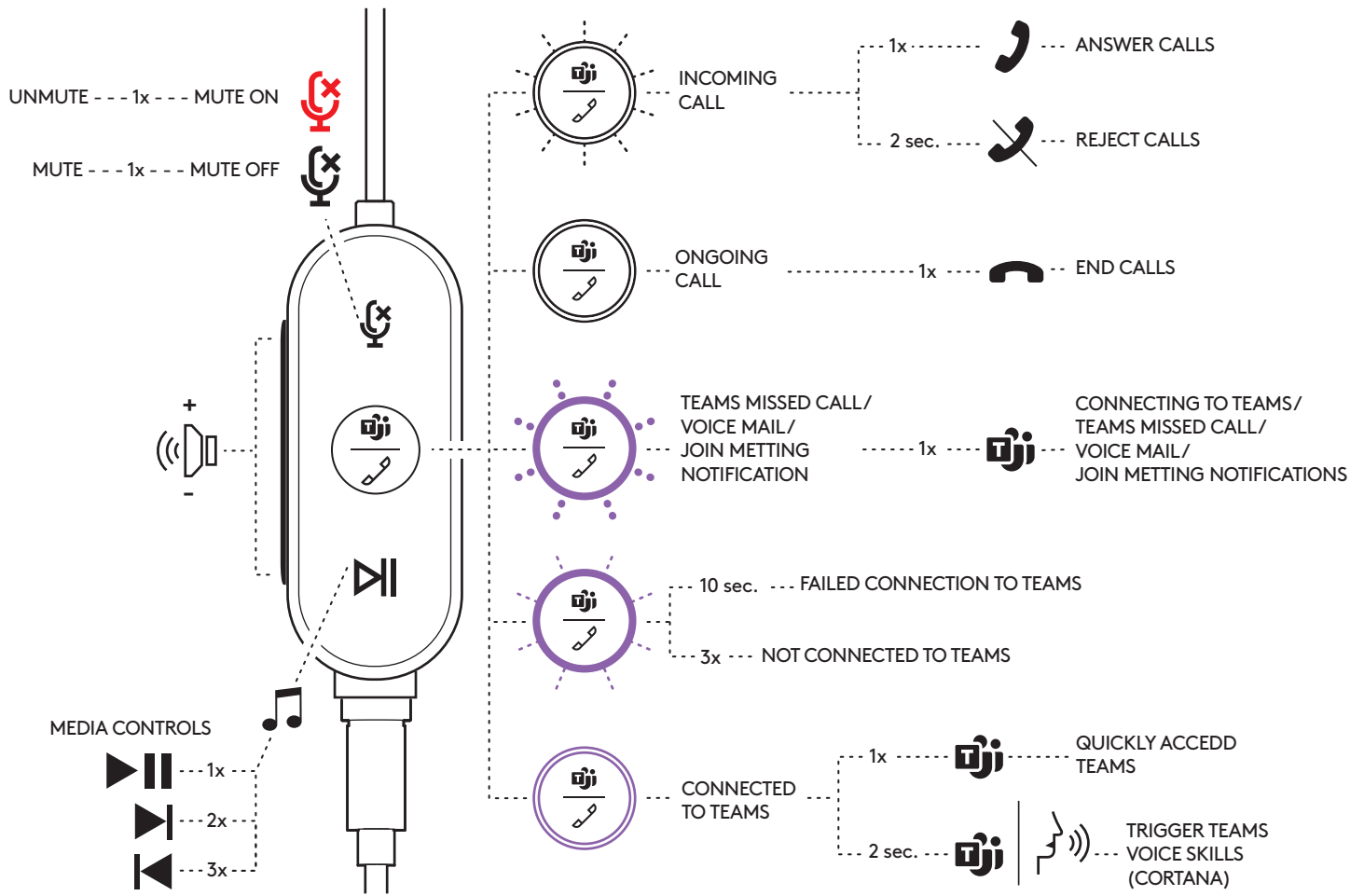
Note: Teams activities are only functional when Teams is running on unlocked PC or Mac.



| UC version | | | | |
|---|-----------------|-----------------|--|------------------------------|
| Button | Usage | Indicator Light | Action | |
|  | Mute | Mute on | Solid RED | Short press to mute / unmute |
| | | Mute off | No light | |
|  | Call Controls | Incoming calls | Flashing WHITE | Short press to answer calls |
| | | Ongoing calls | Solid WHITE | Short press to end calls |
| | Voice Assistant | No light | 2 second press to trigger voice assistant* | |
|  | Media Controls | No light | Short press to play / pause | |
| | | | Double press to track forward | |
| | | | Triple press to track backward | |
| + | Volume | No light | Short press to volume up | |
| - | | | Short press to volume down | |

*Voice assistant functionality may depend on device models.

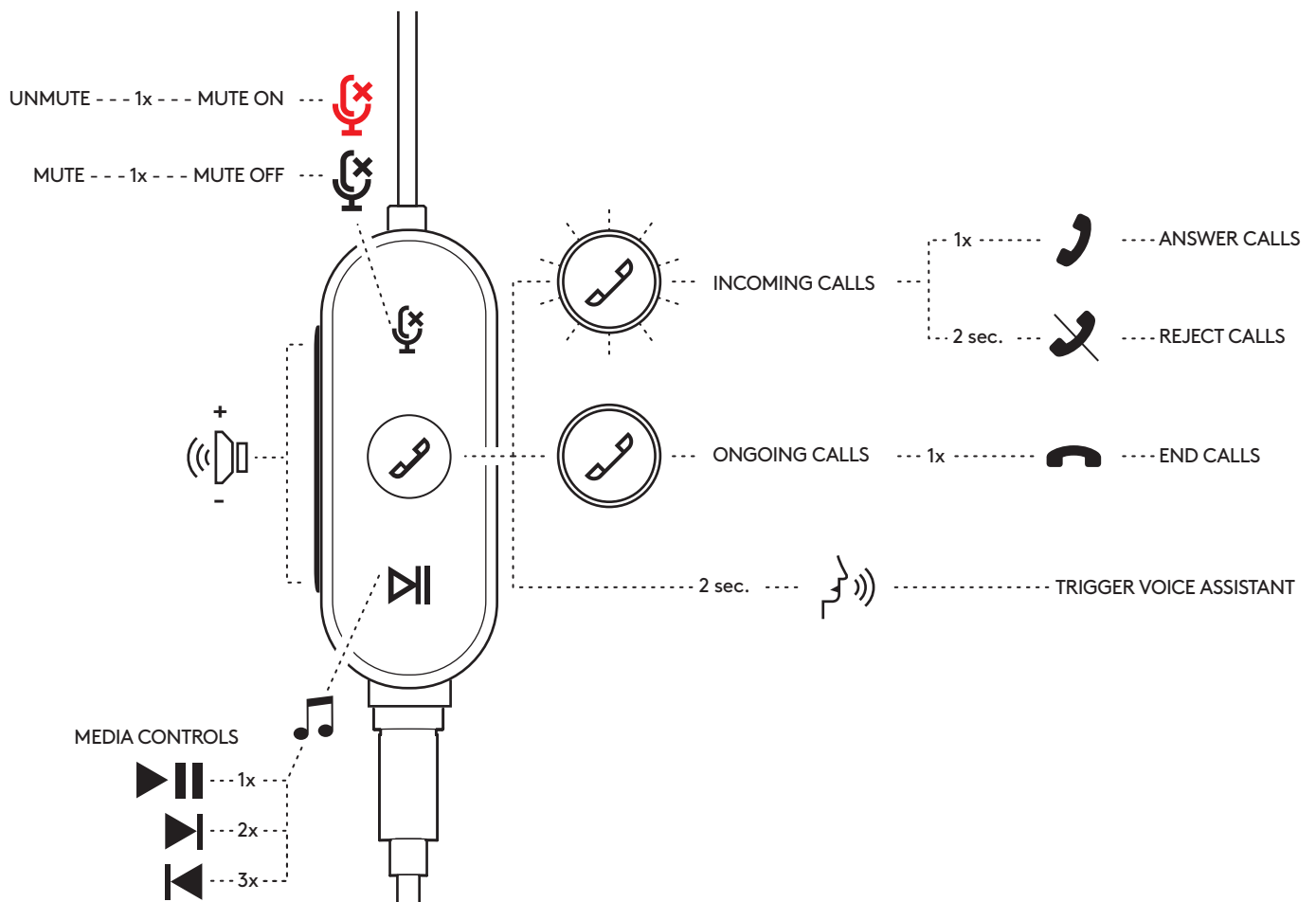

LOGI TUNE

Logi Tune helps boost your earbud performance with periodic software and firmware updates.

Learn more and download Logi Tune at:
www.logitech.com/tune

DIMENSION

Earbuds:

Height x Width x Depth: 23.4 mm x 23.1 mm x 27.3 mm

Weight: 0.033 Kg

Adapter:

Height x Width x Depth: 24.5 mm x 15.4 mm x 8.6 mm

SYSTEM REQUIREMENTS

Works with Windows, Mac, or Chrome™ based computer and Android™ or iOS based mobile devices via available 3.5 mm, USB-C or USB-A port. 3.5 mm connector compatibility may depend on device models. Functionality for mobile devices with USB-C depends on device models.

TECHNICAL SPECIFICATIONS

Input Impedance: 16 Ohms

Sensitivity (headphone): 117dB SPL/1mW/1KHz (driver level)

Sensitivity (microphone): Dual mic configuration each with -38dBV/Pa (mic component level)

Frequency response (Headset): 20-15kHz

Frequency response (Microphone): 100-8kHz

Cable length: 1.45 m

www.logitech.com/support/zonewiredearbuds

PRÉSENTATION DU PRODUIT

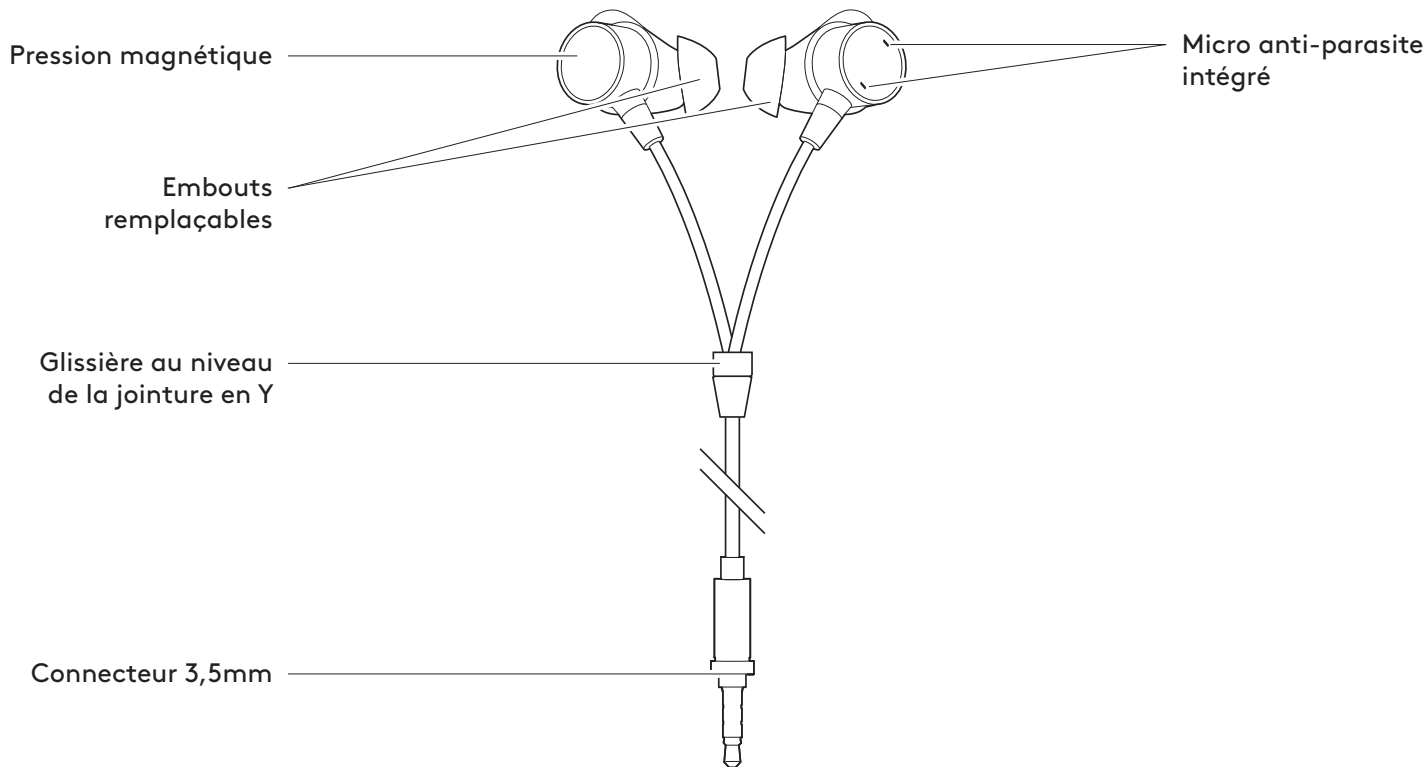

CONTRÔLEUR INTÉGRÉ

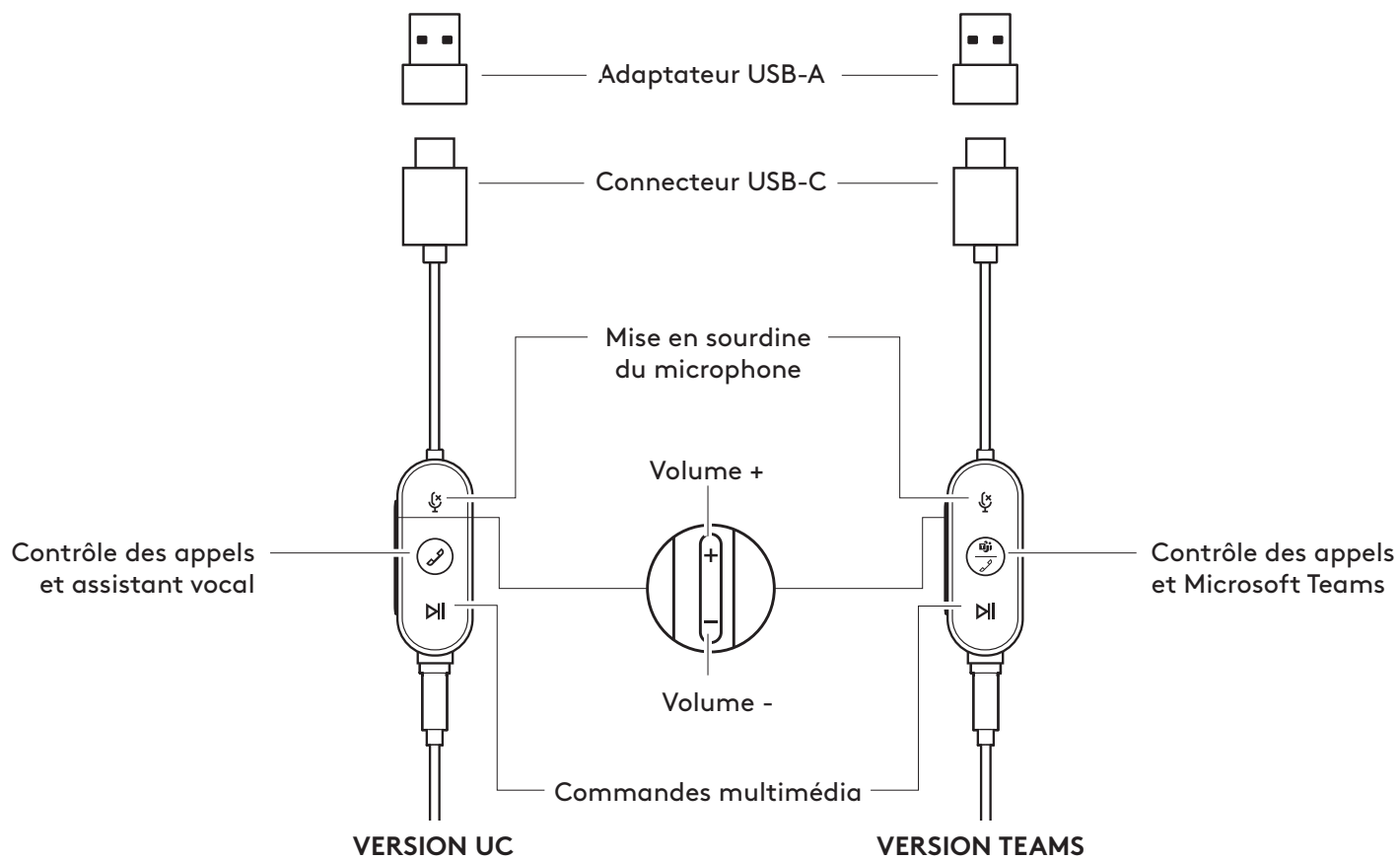

CONTENU DU COFFRET

1. Écouteurs filaires avec coussinets de taille M et connecteur 3,5mm
2. Contrôleur intégré avec connecteur USB-C
3. Adaptateur USB-A
4. Pochette de transport
5. Coussinets remplaçables (1 paire par taille XS/S/L)
6. Documentation utilisateur

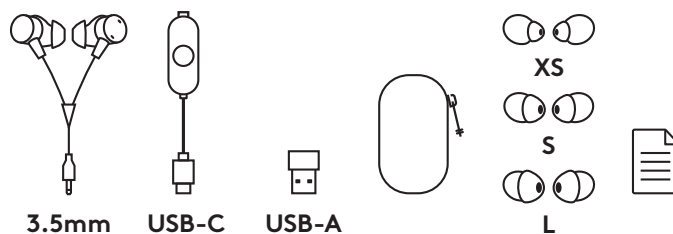

CONNEXION DES ÉCOUTEURS

Connexion par câble 3,5 mm

1. Débranchez le connecteur 3,5mm du contrôleur intégré
2. Branchez le connecteur 3,5mm dans le port 3,5mm de votre dispositif mobile ou votre tablette.

Remarque: la compatibilité dépend des modèles des dispositifs.
La qualité audio et micro sera convertie en mode analogique avec le connecteur 3,5 mm.

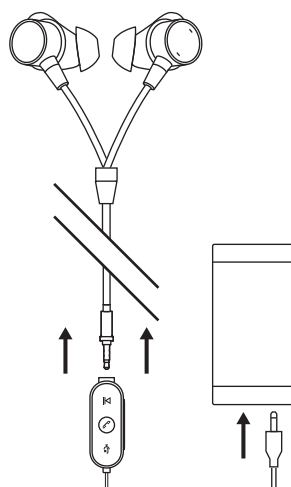

Connexion via USB-C

1. Branchez le connecteur 3,5 mm dans le contrôleur.*
2. Ensuite, branchez le connecteur USB-C dans le port USB-C de l'ordinateur.

Remarque: la compatibilité dépend des modèles des dispositifs.

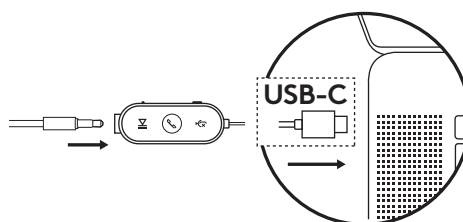

Connexion via USB-A

1. Branchez le connecteur 3,5 mm dans le contrôleur.*
2. Branchez le connecteur USB-C à l'adaptateur USB-A.
3. Branchez le connecteur USB-A dans le port USB-A de votre ordinateur.

Remarque: Utilisez uniquement l'adaptateur USB-A avec les écouteurs fournis.

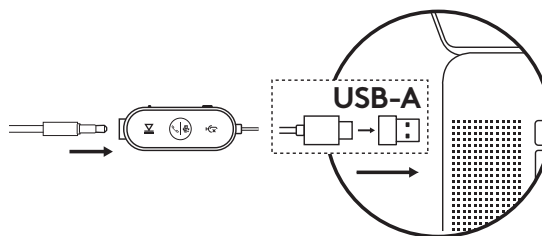

*Assurez-vous que le connecteur 3,5 mm est entièrement inséré dans le contrôleur.

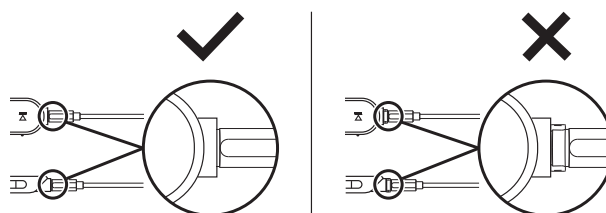

MAINTIEN DES ÉCOUTEURS

1. Les écouteurs portent les lettres L et R pour indiquer respectivement l'oreille gauche et l'oreille droite. Les écouteurs sont conçus avec des coussinets de taille moyenne prêts à l'emploi.

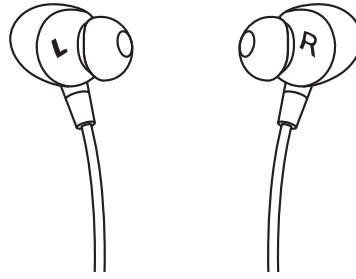

2. Déplacez légèrement l'écouteur pour le placer en sécurité dans votre oreille.

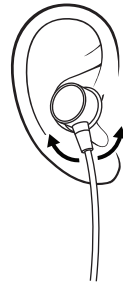

3. Si vous n'êtes pas à l'aise avec vos écouteurs, changez de taille d'écouteurs. Consultez la section suivante pour connaître les étapes de remplacement.

- Essayez une plus petite taille si vous ressentez trop de pression sur votre oreille, ou une taille plus grande si les écouteurs sont instables.
- Notez que vous pouvez utiliser des coussinets de taille différente dans chaque oreille, car vos oreilles peuvent ne pas avoir la même taille.

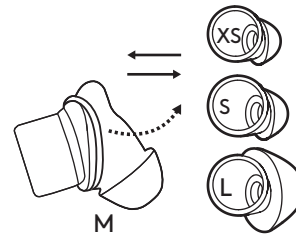

4. Déplacez la glissière sur la jointure en Y vers le haut ou le bas pour ajuster la longueur du câble.

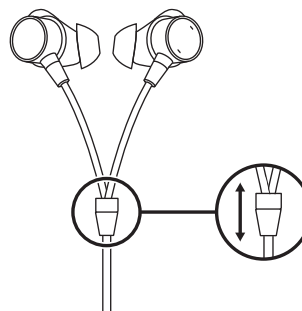

REPLACEMENT DES COUSSINETS

1. Tenez le corps de l'écouteur avec une main.
2. Avec l'autre main, retirez doucement le coussinet entier du corps de l'écouteur.

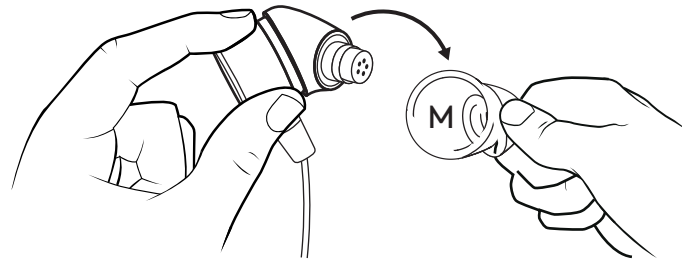
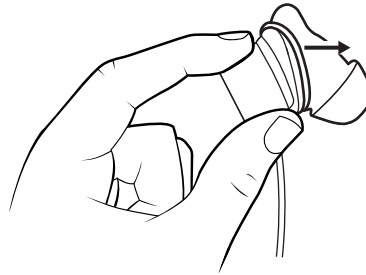

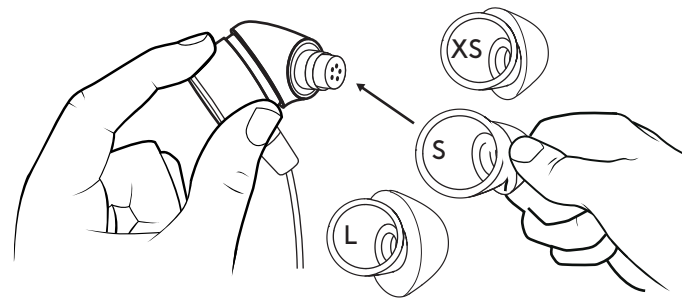

3. Prenez des coussinets d'une taille différente.
Vous trouverez la taille à l'intérieur du coussinet.

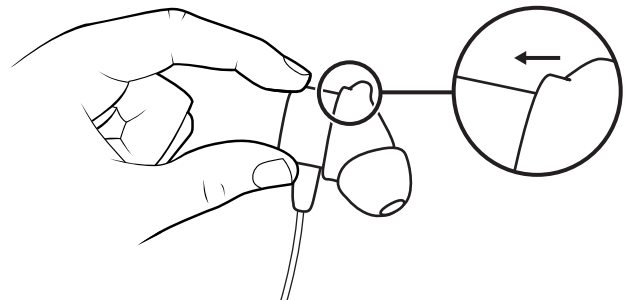

4. Étirez doucement le coussinet sur l'écouteur, jusqu'à ce qu'il n'y ait plus d'espace entre le coussinet et le corps de l'écouteur.





COMMANDES INTÉGRÉES ET TÉMOIN LUMINEUX DU CASQUE

| Version TEAMS | | | | |
|---|-----------------------------|---|---|---|
| Bouton | Utilisation | | Témoin lumineux | Action |
|  | Sourdine | Sourdine activée | Témoin ROUGE en continu | Brève pression pour mettre en sourdine/ activer le micro |
| | | Sourdine désactivée | Aucun signal lumineux | |
|  | Commandes des appels | Appels entrants | Témoin BLANC clignotant | Brève pression pour prendre les appels |
| | | Appels en cours | Témoin BLANC en continu | Pression de 2 secondes pour rejeter les appels |
| | Activités Teams | Connexion à Teams | Témoin VIOLET clignotant | Brève pression pour contrôler la connexion à Teams |
| | | Échec de la connexion à Teams | Témoin VIOLET clignotant pendant 10 secondes, puis extinction | |
| | | Non connecté à Teams | Témoin VIOLET clignotant 3 fois, puis extinction | |
| | | Connecté à Teams | Témoin VIOLET continu | Brève pression pour accéder rapidement à Teams |
| Appel manqué/Messagerie vocale/Notifications d'invitation aux réunions Teams | Témoin VIOLET clignotant | Pression de 2 secondes pour déclencher les fonctions d'assistant vocal de Teams (Cortana) | Brève pression pour répondre aux notifications Teams | |
|  | Commandes multimédia | | Aucun signal lumineux | Brève pression pour lire/mettre en pause |
| | | | | Deux pressions pour passer à la piste suivante |
| | | | | Trois pressions pour passer à la piste précédente |
| + | Volume | | Aucun signal lumineux | Brève pression pour augmenter le volume |
| - | | | | Brève pression pour baisser le volume |

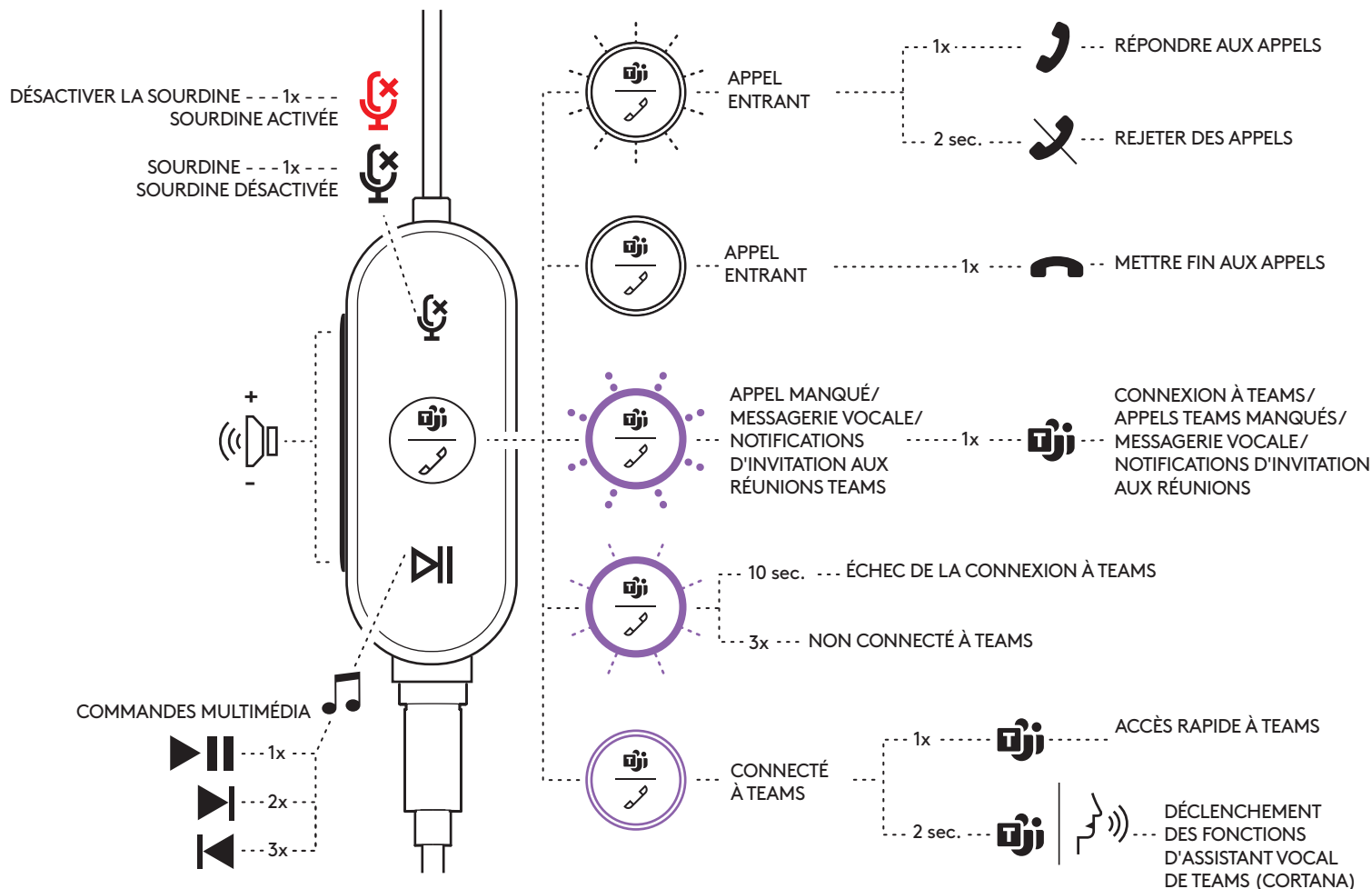
Remarque: Les activités Teams ne sont fonctionnelles que lorsque Teams fonctionne sur un PC ou un Mac déverrouillé.



| Version UC | | | | |
|---|-----------------------------|---------------------|-------------------------|---|
| Bouton | Utilisation | | Témoin lumineux | Action |
|  | Sourdine | Sourdine activée | Témoin ROUGE en continu | Brève pression pour mettre en sourdine/ activer le micro |
| | | Sourdine désactivée | Aucun signal lumineux | |
|  | Commandes des appels | Appels entrants | Témoin BLANC clignotant | Brève pression pour prendre les appels |
| | | Appels en cours | Témoin BLANC en continu | Pression de 2 secondes pour rejeter les appels |
| | Assistant vocal | | Aucun signal lumineux | Brève pression pour mettre fin aux appels |
|  | Commandes multimédia | | | Brève pression pour lire/mettre en pause |
| | | | Aucun signal lumineux | Deux pressions pour passer à la piste suivante |
| | | | | Trois pressions pour passer à la piste précédente |
| + | Volume | | | Brève pression pour augmenter le volume |
| - | | | | Brève pression pour baisser le volume |

* La fonctionnalité de l'assistant vocal peut dépendre des modèles.

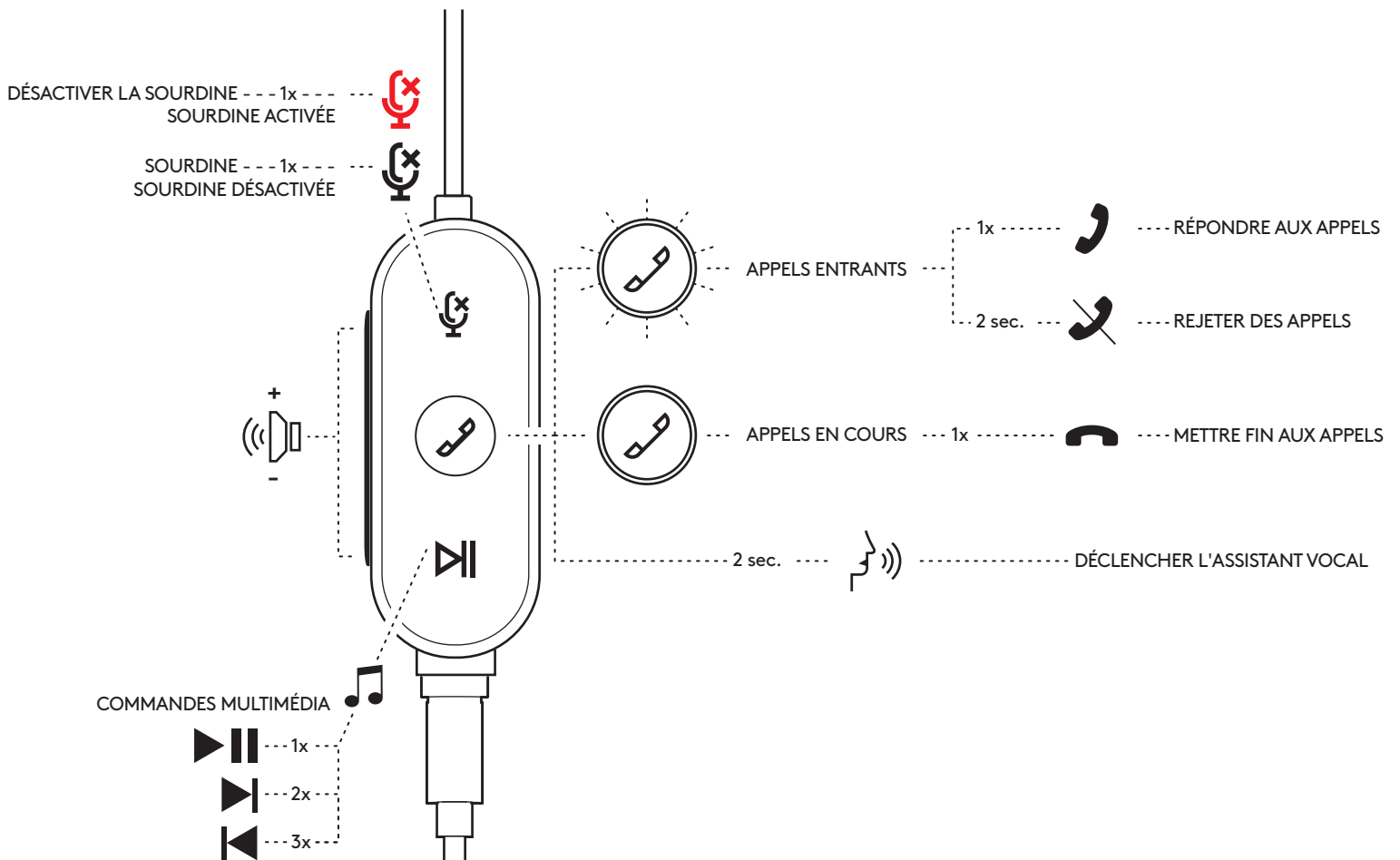

LOGI TUNE

Logi Tune vous aide à booster les performances de vos écouteurs avec des mises à jour régulières du logiciel et du micrologiciel.

En savoir plus sur Logi Tune Desktop et le télécharger sur:
www.logitech.com/tune

DIMENSIONS

Écouteurs:

Hauteur x largeur x profondeur: 23,4 mm x 23,1 mm x 27,3 mm

Poids: 0,033 kg

Adaptateur:

Hauteur x Largeur x Épaisseur: 24,5 mm x 15,4 mm x 8,6 mm

CONFIGURATION REQUISE

Compatible avec les ordinateurs sous Windows, Mac ou Chrome™ et les dispositifs mobiles sous Android™ ou iOS via les ports 3,5mm, USB-C, USB-A disponibles. La compatibilité du connecteur 3,5mm dépend des modèles des dispositifs. Le fonctionnement avec les dispositifs mobiles en mode USB-C dépend des modèles des dispositifs.

SPÉCIFICATIONS TECHNIQUES

Impédance d'entrée: 16 ohms

Sensibilité (casque): Niveau 117dB SPL/1mW/1KHz au niveau des transducteurs

Sensibilité (microphone): Configuration à deux micros dotés chacun d'un niveau de -38dBV/Pa au niveau du micro

Réponse en fréquence (casque): 20 à 15 kHz

Réponse en fréquence (microphone): 100-8kHz

Longueur du câble: 1,45 m

www.logitech.com/support/zonewiredearbuds

COMPONENTES DEL PRODUCTO

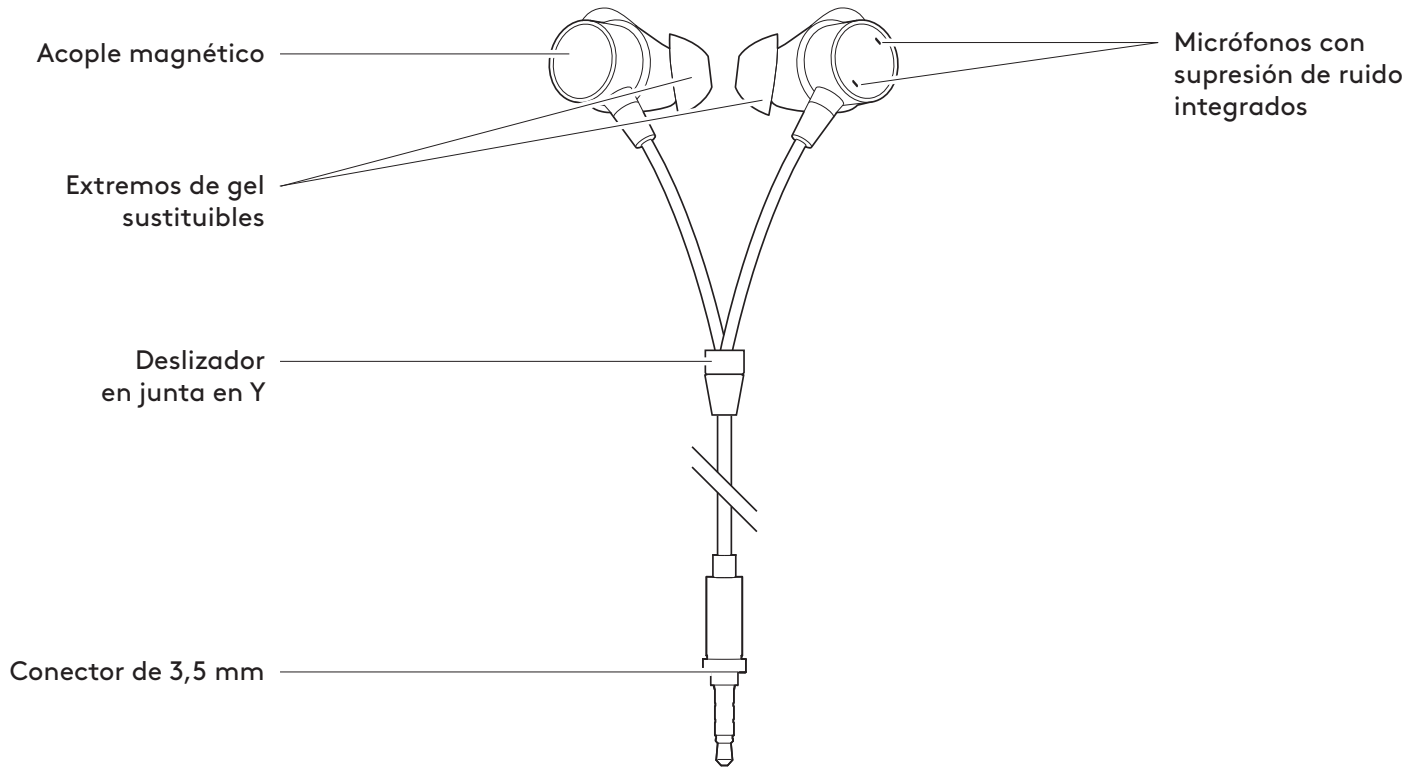

CONTROLADOR INTEGRADO EN EL CABLE

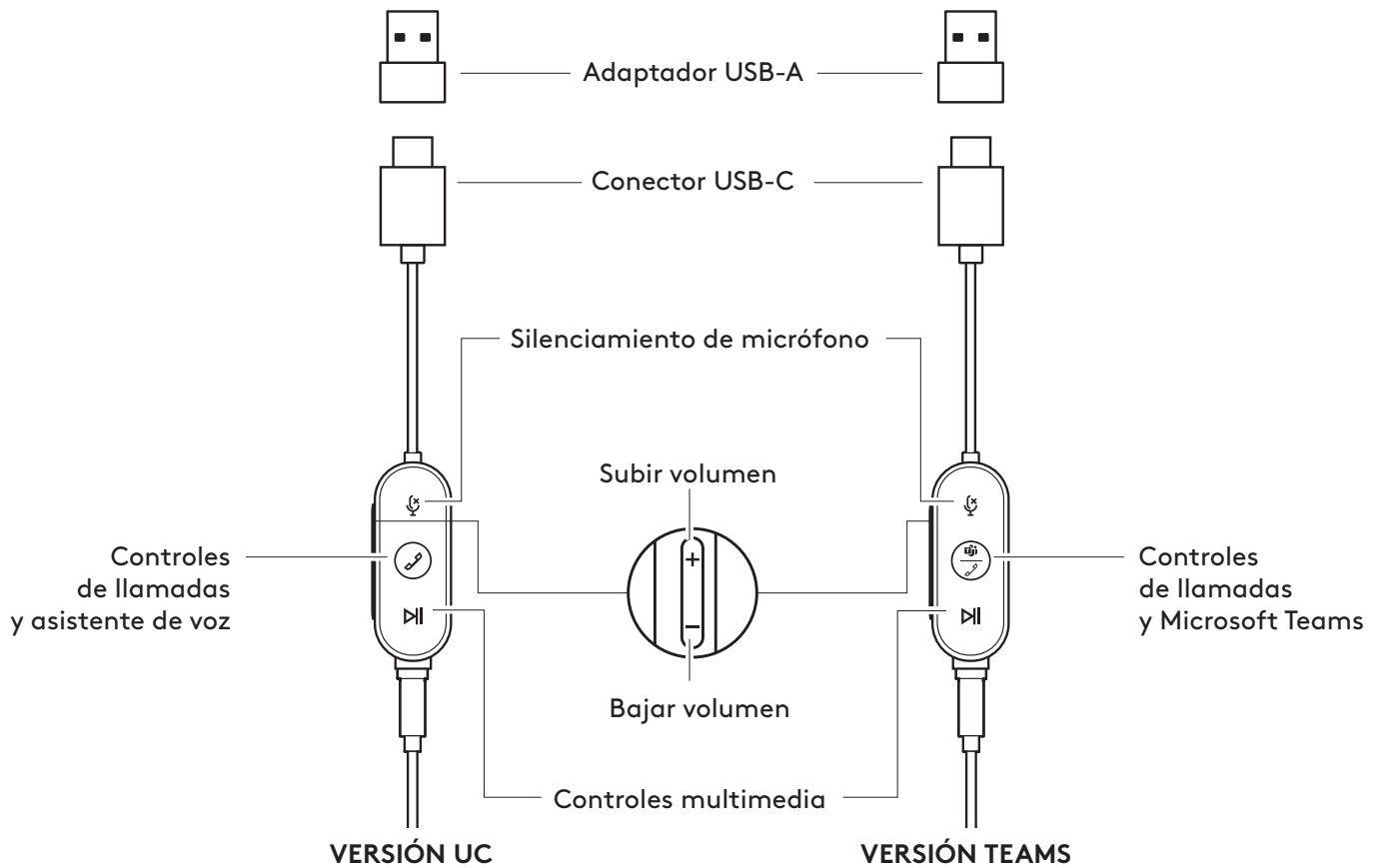

CONTENIDO DE LA CAJA

1. Auriculares con cable, extremos de gel tamaño M y conector de 3,5 mm
2. Controlador integrado en el cable con conector USB-C
3. Adaptador USB-A
4. Bolsa de viaje
5. Extremos de gel sustituibles (1 par de cada tamaño XS/S/L)
6. Documentación del usuario

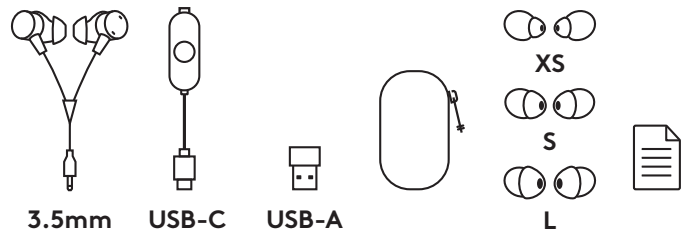

CONEXIÓN DE LOS AURICULARES

Mediante el conector de 3,5 mm

1. Desconecta el conector de 3,5 mm del controlador integrado en el cable.
2. Conecta el conector de 3,5 mm al puerto de 3,5 mm de tu celular o tablet.

Nota: la compatibilidad puede depender del modelo del dispositivo.
Conversión de micrófono y calidad de audio a analógico mediante conector de 3,5 mm.

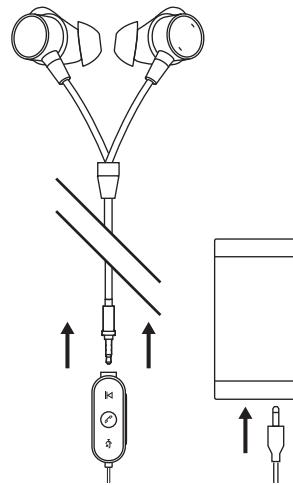

Mediante USB-C

1. Conecta el conector de 3,5 mm al controlador.*
2. A continuación, conecta el conector USB-C al puerto USB-C de la computadora.

Nota: la compatibilidad puede depender del modelo del dispositivo.

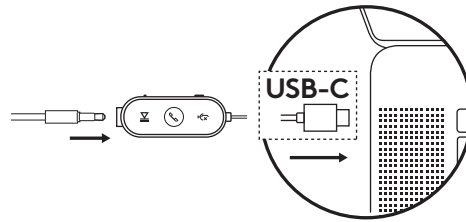

Mediante USB-A

1. Conecta el conector de 3,5 mm al controlador.*
2. Conecta el conector USB-C al adaptador USB-A.
3. Conecta el conector USB-A al puerto USB-A de la computadora.

Nota: usa el adaptador USB-A únicamente con los auriculares suministrados.

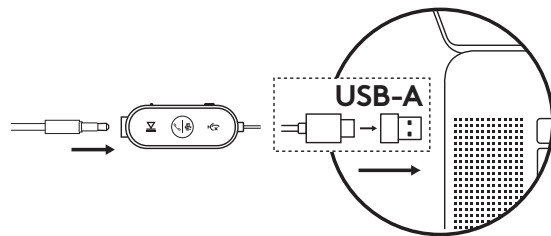

*El conector de 3,5 mm debe estar totalmente insertado en el controlador.

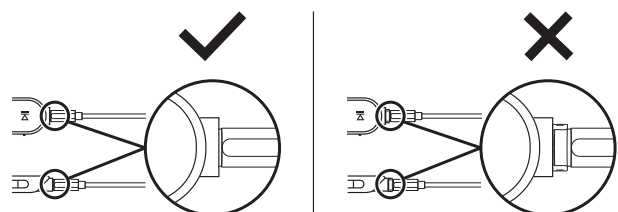

AJUSTE DE AURICULARES

1. Los auriculares están marcados con las letras "L", de Left, y "R", de Right, para el oído izquierdo y el derecho respectivamente. Se suministran con los extremos de gel de tamaño mediano ya insertados.

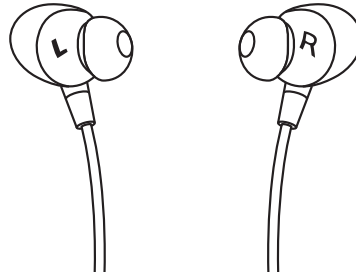

2. Colócate el auricular y muévelo ligeramente para asentarlo firmemente.

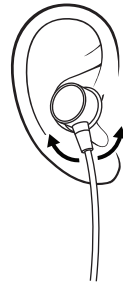

3. Si los auriculares no te parecen cómodos, usa otro tamaño de extremos de gel. En la sección siguiente se indica el procedimiento de sustitución.

- Prueba un tamaño inferior si notas una presión excesiva; o un tamaño superior si notas los auriculares sueltos.
- Puede que necesites un tamaño de extremo distinto para cada oído, dado que ambas orejas no tienen por qué ser idénticas.

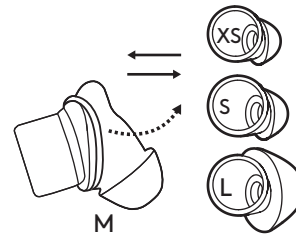

4. Mueve hacia arriba o hacia abajo el deslizador de la junta en Y para ajustar la longitud del cable.

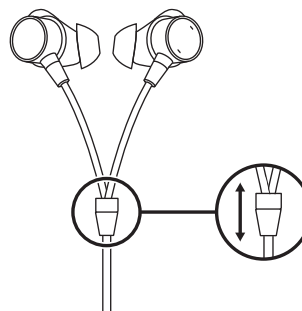

SUSTITUCIÓN DE EXTREMOS DE GEL

1. Sujeta el cuerpo del auricular con una mano.
2. Con la otra mano, tira suavemente para extraer el extremo de gel.

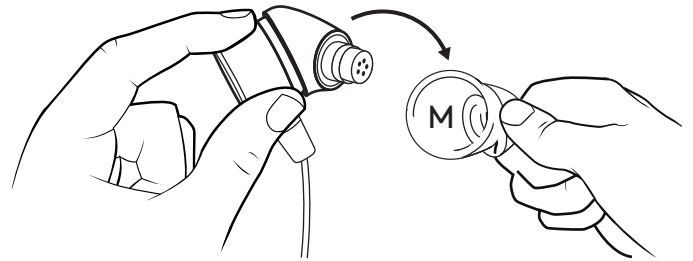
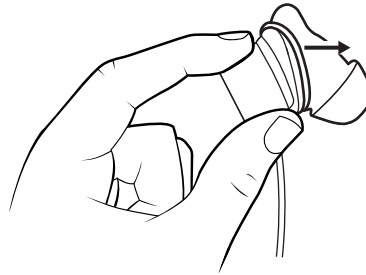

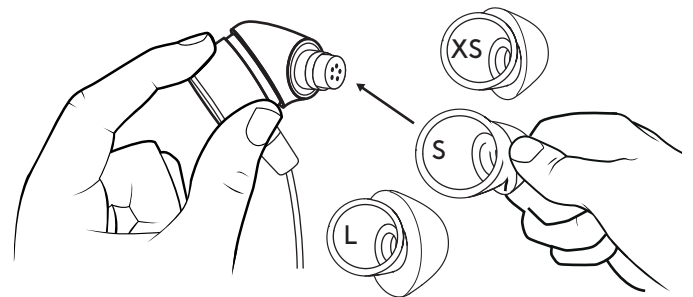

3. Elige otro tamaño de extremo. El tamaño se indica en el interior del extremo de gel.

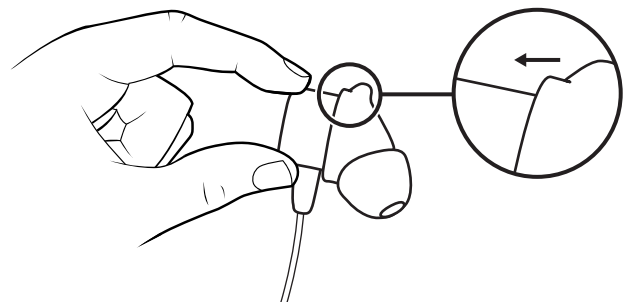

4. Expande con cuidado el extremo de gel en el auricular, de modo que ambos componentes estén en estrecho contacto, sin espacio entre ambos.





CONTROLES INTEGRADOS EN EL CABLE DE LOS AUDÍFONOS E INDICADOR LUMINOSO

| Versión Teams | | | | |
|---|--|---------------------------|--|--|
| Botón | Uso | | Indicador luminoso | Acción |
|  | Silencio | Silencio activado | ROJO permanente | Pulsación corta para silenciar/reactivar sonido |
| | | Desactivar silenciar | Apagado | |
|  | Controles de llamadas | Llamadas entrantes | Destellos BLANCOS | Pulsación corta para contestar llamadas |
| | | Llamadas en curso | BLANCO permanente | Pulsación de 2 segundos para rechazar llamadas |
| | | Llamadas en curso | BLANCO permanente | Pulsación corta para finalizar llamadas |
| | Actividades de Teams | Conectando a Teams | Pulsos MORADOS | Pulsación corta para comprobar la conexión a Teams |
| | | Error al conectar a Teams | Destellos MORADOS durante 10 segundos y luego se apagará | |
| | | No hay conexión a Teams | Destellos MORADOS 3 veces y luego se apagará | |
| | | Conexión a Teams | MORADO permanente | Pulsación corta para acceder rápidamente a Teams |
| | Llamada perdida/Correo de voz/Notificaciones de incorporación a reunión de Teams | Pulsos MORADOS | Pulsación de 2 segundos para activar las habilidades de voz de Teams (Cortana) | |
|  | Controles multimedia | | Apagado | Pulsación corta para Reproducir/Pausar |
| | | | | Doble pulsación para avanzar pista |
| | | | | Triple pulsación para retroceder pista |
| + - | Volumen | | Apagado | Pulsación corta para subir volumen |
| | | | | Pulsación corta para bajar volumen |

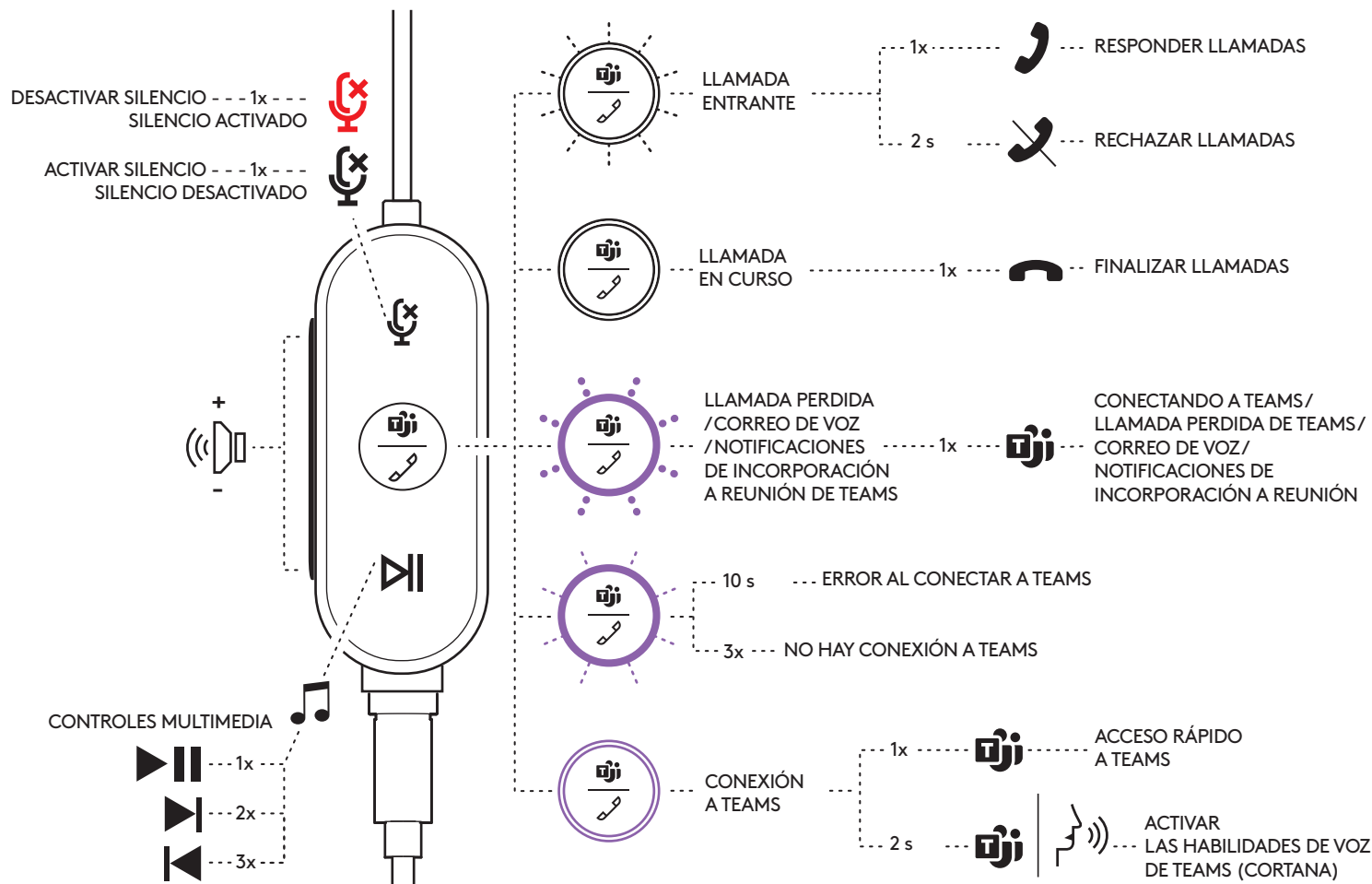
Nota: las actividades de Teams sólo funcionan cuando Teams se ejecuta en una PC o Mac desbloqueadas.



| Versión UC | | | | |
|---|------------------------------|----------------------|-------------------|---|
| Botón | Uso | Indicador luminoso | Acción | |
|  | Silencio | Silencio activado | ROJO permanente | Pulsación corta para silenciar/ reactivar sonido |
| | | Desactivar silenciar | Apagado | |
|  | Controles de llamadas | Llamadas entrantes | Destellos BLANCOS | Pulsación corta para contestar llamadas |
| | | Llamadas en curso | BLANCO permanente | Pulsación de 2 segundos para rechazar llamadas |
| | Asistente de voz | | Apagado | Pulsación de 2 segundos para activar el asistente de voz* |
|  | Controles multimedia | | Apagado | Pulsación corta para Reproducir/Pausar |
| | | | | Doble pulsación para avanzar pista |
| | | | | Triple pulsación para retroceder pista |
| + | Volumen | | Apagado | Pulsación corta para subir volumen |
| - | | | Apagado | Pulsación corta para bajar volumen |

*La función de asistente de voz puede depender de los modelos de dispositivo.

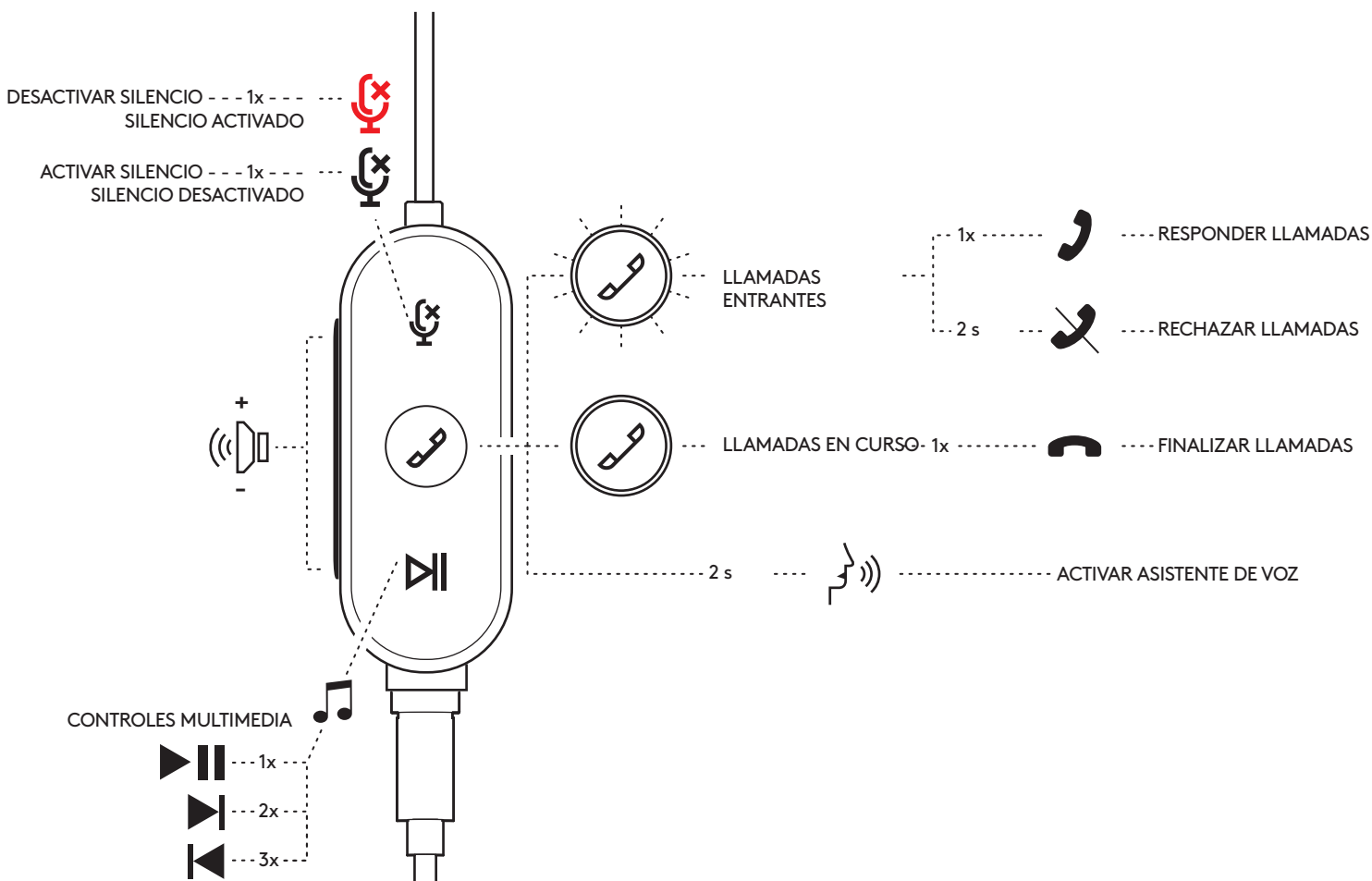

LOGI TUNE

Logi Tune optimiza el rendimiento de los auriculares con actualizaciones periódicas de software y firmware.

Obtén más información y descarga Logi Tune para escritorio en:

www.logitech.com/tune

DIMENSIONES

Auriculares:

Altura x Anchura x Profundidad: 23,4 mm x 23,1 mm x 27,3 mm

Peso: 0,033 kg

Adaptador:

Altura x Anchura x Profundidad: 24,5 mm x 15,4 mm x 8,6 mm

REQUISITOS DEL SISTEMA

Computadora Windows, Mac o Chrome™ o dispositivo móvil Android™ o iOS con toma de 3,5 mm o puerto USB-C o USB-A disponible. La compatibilidad de conector de 3,5 mm puede depender del modelo del dispositivo. La funcionalidad de los dispositivos móviles con USB-C depende del modelo de dispositivo.

ESPECIFICACIONES TÉCNICAS

Impedancia de entrada: 16 ohmios

Sensibilidad (audífono): 117 dB SPL/1mW/1 kHz (a nivel de transductor)

Sensibilidad (micrófono): Configuración de dos micrófonos con niveles de componente de micrófono -38 dBV/Pa

Respuesta de frecuencia (auriculares): 20 Hz-15 kHz

Respuesta de frecuencia (micrófono): 100 Hz-8 kHz

Longitud de cable: 1,45 m

www.logitech.com/support/zonewiredearbuds

CONHECER O PRODUTO

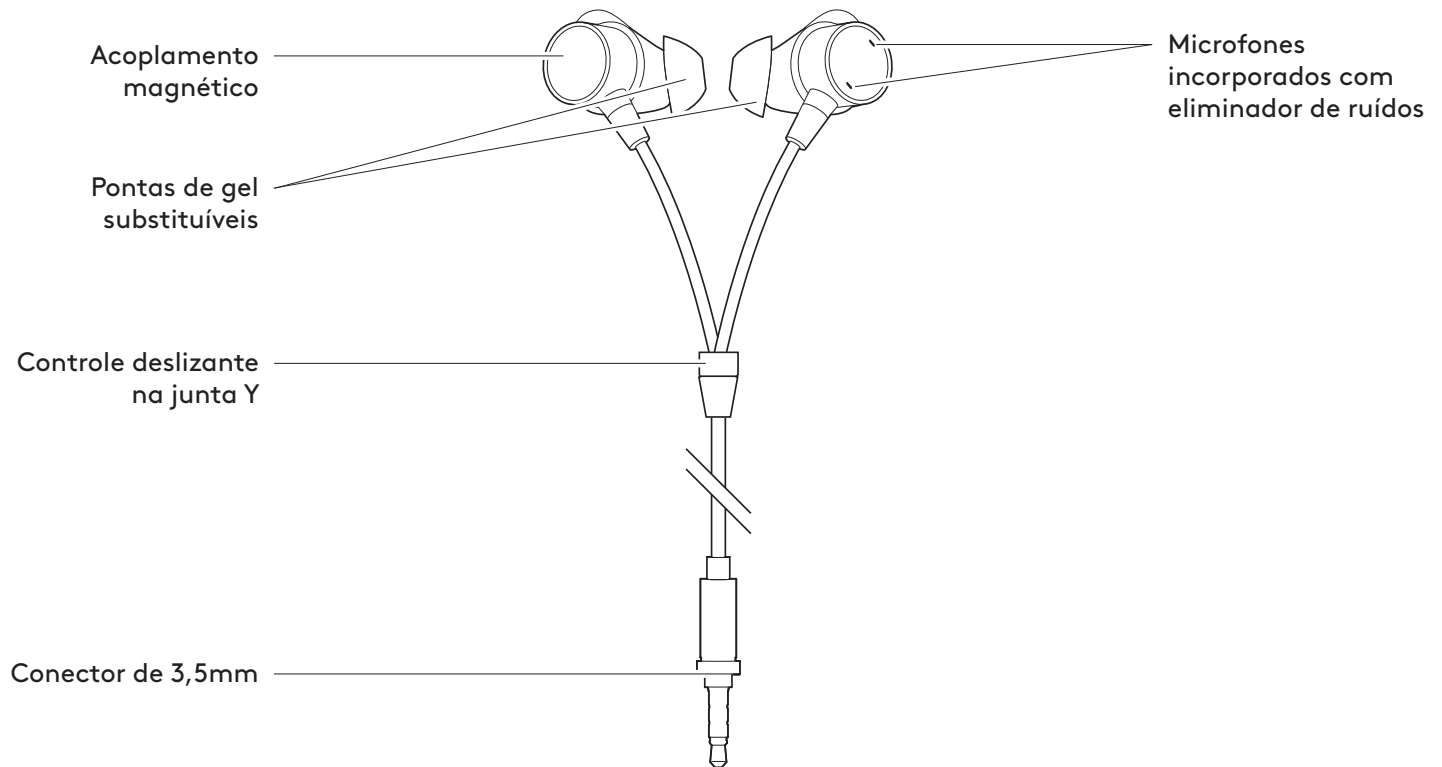

CONTROLADOR INTEGRADO NO FIO

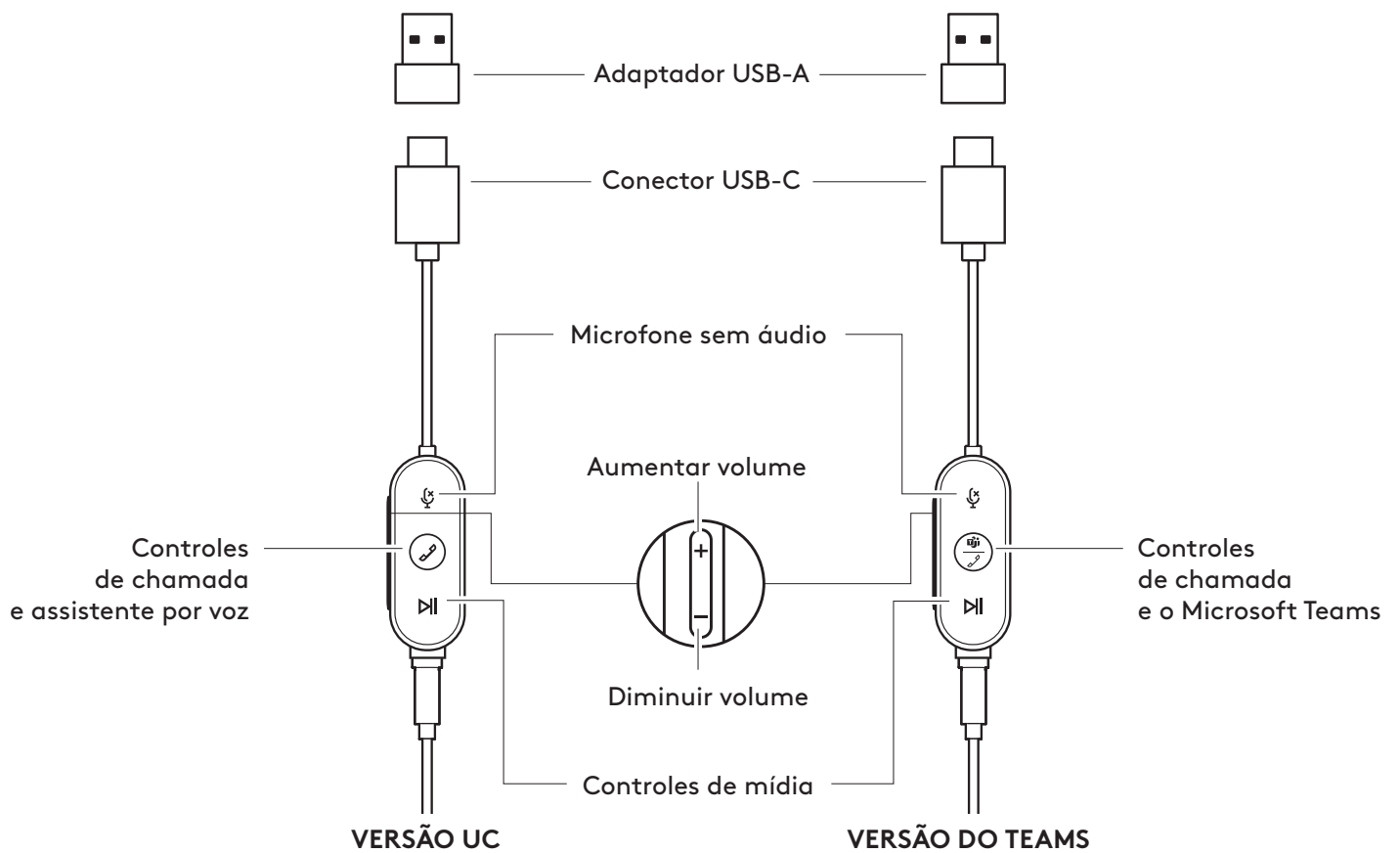

CONTEÚDO DA CAIXA

1. Fones de ouvido com fio com pontas de gel tamanho M e conector de 3,5mm
2. Controlador em linha com conector USB-C
3. Adaptador USB-A
4. Bolsa para transporte
5. Pontas de gel substituíveis (1 par por tamanho XS/S/L)
6. Documentação do usuário

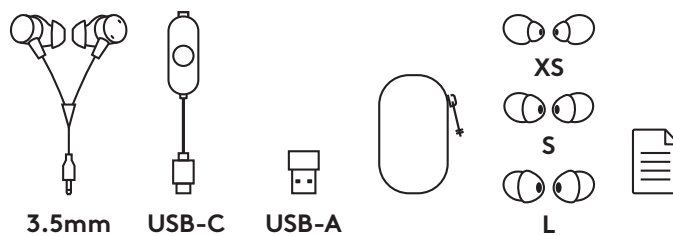

CONECTANDO O FONE DE OUVIDO

Conectar por cabo de 3,5 mm

1. Desconecte o conector de 3,5mm do controlador em linha.
2. Conecte o conector de 3,5mm à porta de 3,5mm de seu dispositivo móvel ou tablet

Observação: A compatibilidade pode depender dos modelos de dispositivo. Qualidade de microfone e áudio será convertida para analógico com conector de 3,5 mm.

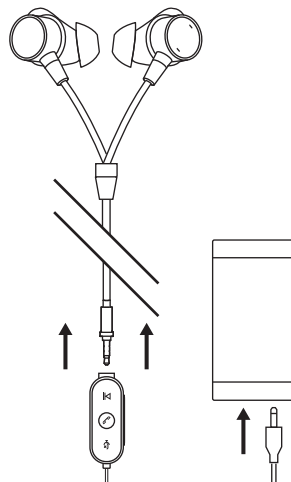

Conectar via USB-C

1. Conecte o conector de 3,5 mm ao controlador.*
2. Conecte o conector USB-C à porta USB-C do seu computador.

Observação: A compatibilidade pode depender dos modelos de dispositivo.

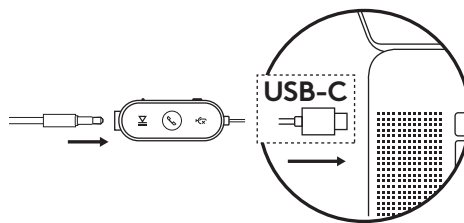

Conectar via USB-A

1. Conecte o conector de 3,5 mm ao controlador.
2. Conecte o conector USB-C ao adaptador USB-A.
3. Conecte o conector USB-A à porta USB-A do computador.

Observação: Use apenas o adaptador USB-A com os fones de ouvido fornecidos.

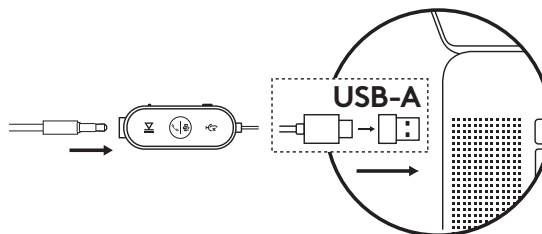

*Certifique-se de que o conector está inserido completamente no controlador.

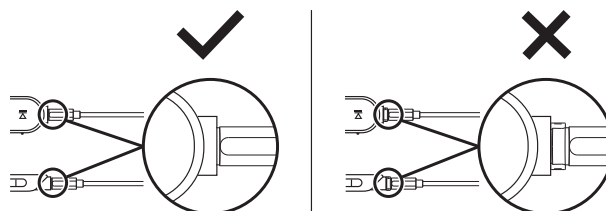

AJUSTE DO FONE DE OUVIDO

1. Os fones de ouvido estão marcados com 'L' e 'R' para a orelha esquerda e direita. Os fones de ouvido são ajustados com pontas de gel de tamanho médio que estão na caixa.

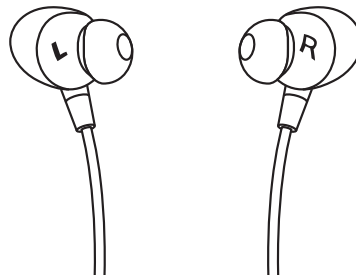

2. Mova um pouco o fone de ouvido em torno para estar posicionado de forma segura em seu ouvido.

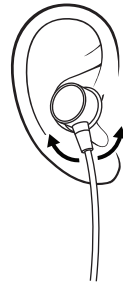

3. Se os fones de ouvido não estão confortáveis, mude para pontas de gel de tamanho alternativo. Consulte a seção a seguir para obter as etapas de substituição.

- Tente usar um tamanho menor se você sente excesso de pressão em seu ouvido ou um tamanho maior se os fones de ouvido estão muito soltos.
- Observe que você pode usar pontas de gel de tamanhos diferentes em cada orelha já que suas orelhas podem não ser do mesmo tamanho.

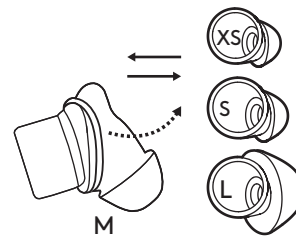

4. Mova o controle deslizante na junta Y para cima e para baixo para ajustar o tamanho do cabo.

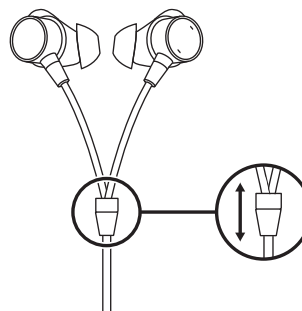

SUBSTITUIR A PONTA DE GEL

1. Segure o corpo da ponta de gel com uma mão.
2. Com a outra mão, puxe gentilmente toda a ponta de gel para fora do corpo do fone de ouvido.

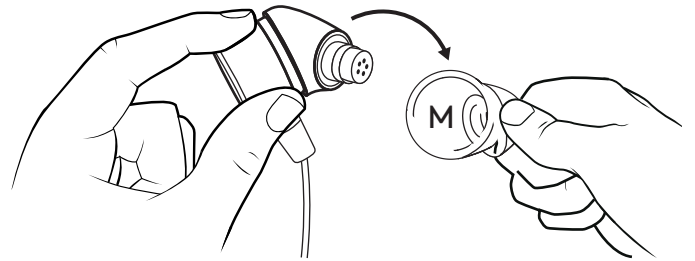
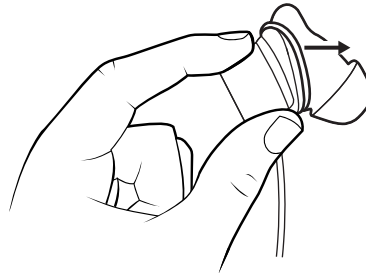

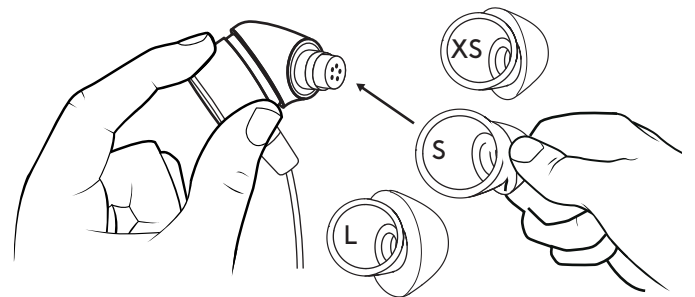

3. Pegue pontas de gel de tamanhos alternativos. Encontre o tamanho dentro da ponta de gel.

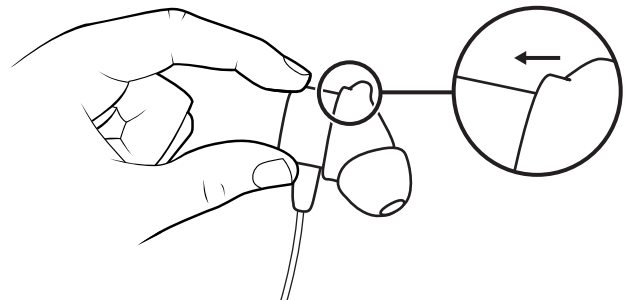

4. Estique gentilmente a ponta de gel para dentro do fone de ouvido até que não haja nenhuma folga entre a ponta de gel e o corpo.





CONTROLES INTEGRADOS NO FIO DO HEADSET E INDICADOR LUMINOSO

| Versão do TEAMS | | | | |
|---|---|------------------------------|--|---|
| Botão | Uso | | Indicador luminoso | Ação |
|  | Sem áudio | Sem áudio ativado | VERMELHO estável | Pressione brevemente para ativar/desativar o áudio |
| | | Sem áudio desativado | Nenhuma luz | |
|  | Controles de chamada | Chamadas recebidas | BRANCO piscando | Pressione brevemente para atender chamadas |
| | | | | Pressione por 2 segundos para rejeitar chamadas |
| | | Chamadas em andamento | BRANCO estável | Pressione brevemente para encerrar chamadas |
| | Atividades do Teams | Conectando-se ao Teams | ROXO piscando | Pressione brevemente para verificar a conexão com o Teams |
| | | Falha na conexão com o Teams | ROXO piscando por 10 segundos e depois desligado | |
| | | Não conectado ao Teams | ROXO piscando 3 vezes e depois desligado | |
| | | Conectado ao Teams | ROXO estável | Pressione brevemente para acessar rapidamente o Teams |
| | | | Pressione por 2 segundos para ativar os recursos de voz do Teams (Cortana) | |
| | Chamadas perdidas/ Caixa postal/Notificações de participação em reuniões do Teams | ROXO piscando | Pressione brevemente para responder às notificações do Teams | |
|  | Controles de mídia | | Nenhuma luz | Pressione brevemente para pausar/reproduzir |
| | | | | Pressione duas vezes para passar para a faixa seguinte |
| | | | | Pressione três vezes para voltar para a faixa anterior |
| + | Volume | | Nenhuma luz | Pressione brevemente para aumentar o volume |
| - | | | | Pressione brevemente para diminuir o volume |

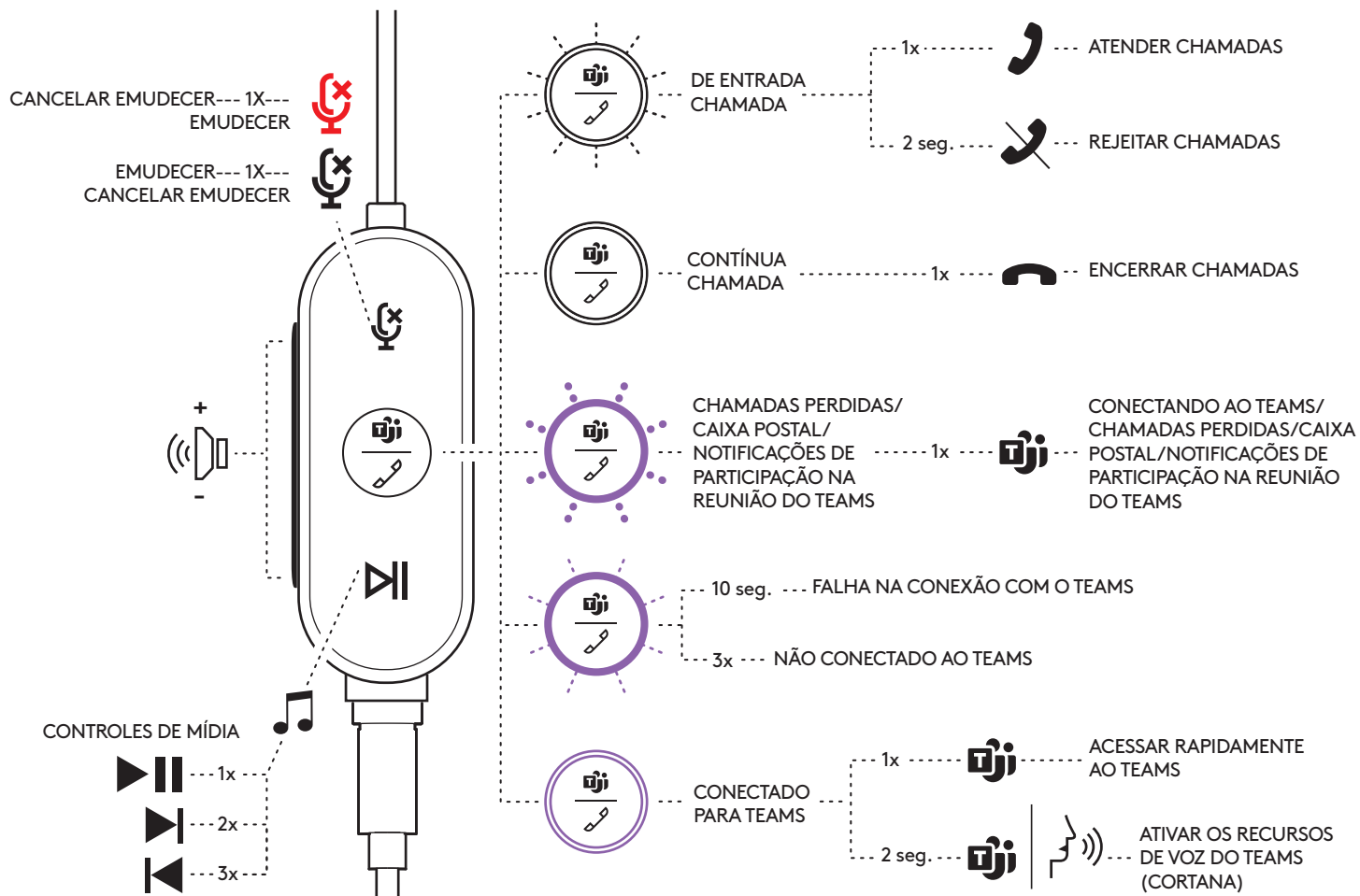
Observação: As atividades do Teams são funcionais apenas quando o Teams estiver sendo executado no PC ou Mac desbloqueado.



| Versão UC | | | | |
|---|----------------------|-----------------------|---|--|
| Botão | Uso | Indicador luminoso | Ação | |
|  | Sem áudio | Sem áudio ativado | VERMELHO estável | Pressione brevemente para ativar/ desativar o áudio |
| | | Sem áudio desativado | Nenhuma luz | |
|  | Controles de chamada | Chamadas recebidas | BRANCO piscando | Pressione brevemente para atender chamadas |
| | | Chamadas em andamento | BRANCO estável | Pressione por 2 segundos para rejeitar chamadas |
| | Assistente por voz | Nenhuma luz | Pressione por 2 segundos para ativar o assistente por voz* | |
|  | Controles de mídia | Nenhuma luz | Pressione brevemente para pausar/ reproduzir | |
| | | | Pressione duas vezes para passar para a faixa seguinte | |
| | | | Pressione três vezes para voltar para a faixa anterior | |
| + | Volume | Nenhuma luz | Pressione brevemente para aumentar o volume | |
| - | | | Pressione brevemente para diminuir o volume | |

*A funcionalidade do assistente por voz pode depender dos modelos de dispositivo.

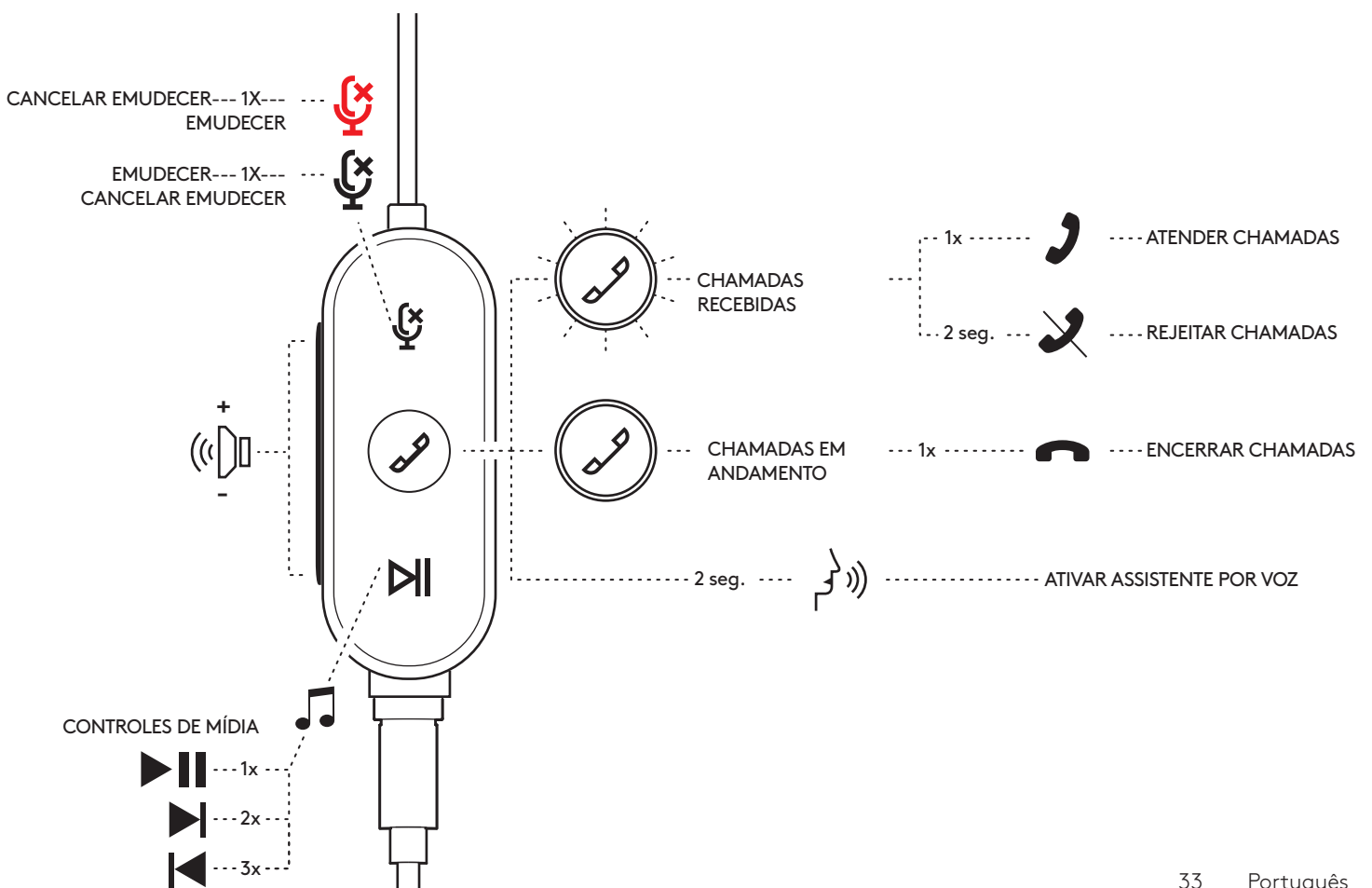

LOGI TUNE

O Logi Tune aumenta o desempenho de seu fone de ouvido com atualizações periódicas de software e firmware.

Saiba mais e faça download do Logi Tune em:
www.logitech.com/tune

DIMENSÃO

Fones de ouvido:

Altura x largura x profundidade: 23,4 mm x 23,1 mm x 27,3 mm

Peso: 0,033 kg

Adaptador:

Altura x largura x profundidade: 24,5 mm x 15,4 mm x 8,6 mm

REQUISITOS DE SISTEMA

Funciona com computador executando o Windows, Mac ou Chrome™ e dispositivos móveis executando o Android™ ou iOS através de uma porta USB-C ou USB-A de 3,5mm. A compatibilidade do conector de 3,5mm pode depender dos modelos de dispositivo. A funcionalidade para dispositivos móveis com USB-C depende dos modelos de dispositivo.

ESPECIFICAÇÕES TÉCNICAS

Impedância de entrada: 16 Ohms

Sensibilidade (fone de ouvido): 117dB SPL/1 mW/1 KHz (no nível do driver)

Sensibilidade (microfone): Configuração com microfones duplos, cada um com -38 dBV/Pa (no nível do componente do microfone)

Resposta de frequência (fone de ouvido): 20-15 kHz

Resposta de frequência (microfone): 100-8kHz

Comprimento do cabo: 1,45m

www.logitech.com/support/zonewiredearbuds