

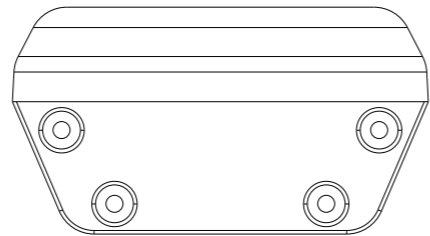

REVISIONS				
REV	DESCRIPTION	ENGINEER	REQUIRE	DATE
1.0	New Edition			Jun-24-19

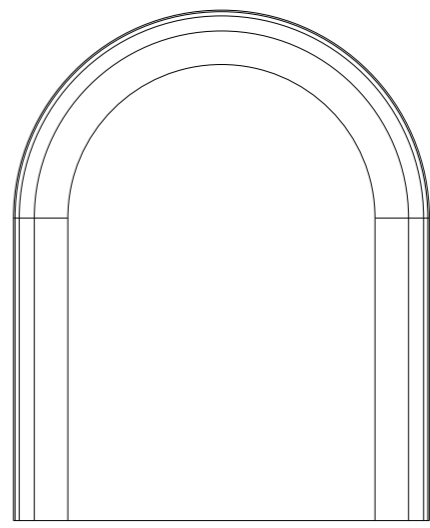
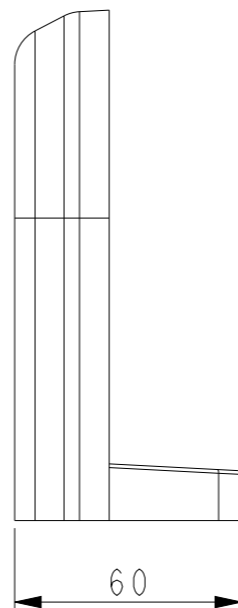
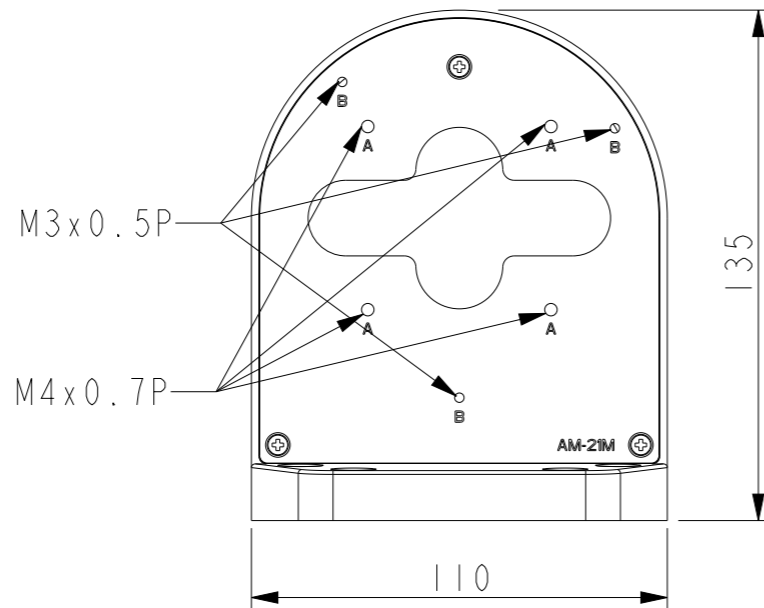
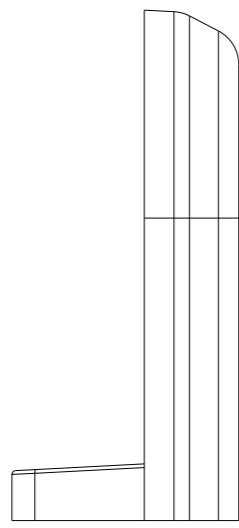
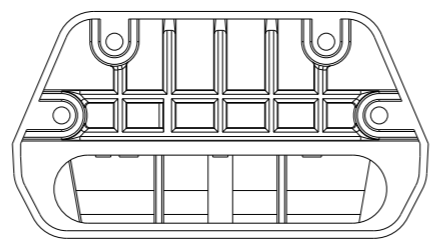

UNLESS OTHERWISE SPECIFIED
ALL DIMENSIONS ARE IN mm

TOLERANCE ON:
 LINEAR : <30 ±0.10
 30-50 ±0.15
 50-100 ±0.18
 100-200 ±0.20
 200-300 ±0.25
 >300 ±0.30

ANGULAR: X ±1°
 X.X ±0.5°

 VIVOTEK Incorporated	PART NO.		MODEL		
	ENGR	Jesen	AM-21M		
<small>THIS DRAWING ON THIS PRINT AND INFORMATION THEREWITH ARE PROPRIETARY TO VIVOTEK INC. AND SHALL NOT BE USED OR DISCUSSED IN WHOLE OR IN PART WITHOUT VIVOTEK'S CONSENT.</small>	DRN	Jesen	DRAWING TITLE		
	CHK		AM-21M-6VIEW		
<small>WI-RD-03-01-4</small>	APRV		DRAWING NO. FORM-V02.2014-12-16		
	M'TL		ISSUE DATE	Jun-24-19	REVISION 1.0
 第三角法	FINISH		SCALE	0,500	UNIT mm
			SIZE	A3	SHEET 1 OF 1