



SD9364-EH



SD9364-EHL

Speed Dome Network Camera



1080p 60 fps · 30x Zoom · 250M/150M IR · Smart IR II · NEMA 4X · IP66 · Defog · -50°C ~ 55°C · EIS · GbE Port

The SD9364-EH/EHL is the latest professional speed dome camera from VIVOTEK, specifically designed to enhance low light surveillance in large coverage areas. Equipped with 250M/150MIR illuminators and a 30x optical zoom lens, the SD9364-EH/EHL provides a superb low light image in the most challenging situations. The SD9364-EH/EHL also adopts VIVOTEK's latest Smart IR II technology, Vari-Angle IR. VIVOTEK's Vari-Angle IR provides smooth vari-angle adjustment of the IR illuminators, allowing broad coverage FOV and highly uniform IR intensity while avoiding hot-spots traditionally associated with IR illumination.

The SD9364-EH/EHL is the PTZ surveillance camera with IR Illumination to utilize H.265 compression technology. When combined with VIVOTEK's Smart Stream II technology, users can obtain bandwidth savings of up to 80%* compared to traditional H.264. By combining 1080p full HD resolution with H.265, IR illuminators, Vari-Angle IR, WDR, and 30x optical zoom, the SD9364-EH/EHL is able to capture fine details at top-notch quality,

24 hours a day, 7 days a week. VIVOTEK further strengthened the camera performance with an IP66- and NEMA 4X-rated housing to protect the camera against rain, dust, and corrosion. The SD9364-EH/EHL has a wide operating temperature range from -50°C to 55°C, ensuring continuous operation under the most extreme weather conditions and hazardous environments. This makes the SD9364-EH/EHL ideally suited to monitor wide open spaces such as ports, highways, cities, and parking lots where high-level precision is required.

As with all VIVOTEK true day/night cameras, the SD9364-EH/EHL features a removable IR-cut filter, maintaining clear images 24 hours a day. Audio detection is included by recognizing changes in ambient noise. The SD9364-EH/EHL also includes a SD/SDHC/SDXC card slot and supports up to 60 fps in 1080P full HD. For the most demanding outdoor surveillance application, there is nothing that compares to the VIVOTEK's SD9364-EH/EHL.

* Depending on scene.

Key Features

- Real-time H.265, H.264 and MJPEG Compression (Triple Codec)
- 1080p HD CMOS Sensor
- 60 fps @ 1080p Full HD
- 30x Zoom Lens, up to 250M IR
- Smart IR II (Vari-Angle IR)
- Removable IR-cut Filter for Day & Night Function
- 360° Continuous Pan and 220° Tilt
- WDR Pro for Unparalleled Visibility in High Contrast Environments
- Weather-proof IP66, Vandal-proof IK10 and NEMA 4X-rated Housing
- -50°C ~ 55°C Wide Temperature Range for Extreme Weather Conditions
- Audio Detection for Instant Alerts
- Auto Tracking for Moving Objects
- Smart Stream II to Optimize Bandwidth Efficiency
- 3D Privacy Masks for Additional Protection
- Built-in SD/SDHC/SDXC Card Slot for On-board Storage
- Defog
- EIS

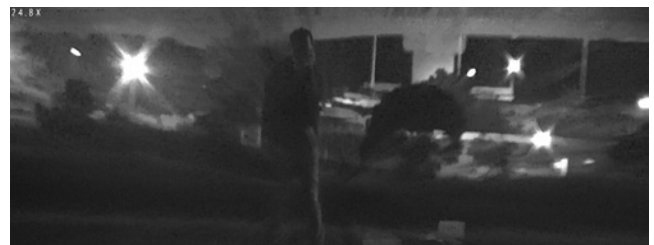

Without Vari-Angle IR



With Vari-Angle IR

Technical Specifications

Model	SD9364-EH(with Bracket, IO Cable): 30x, 250M IR SD9364-EH(without Bracket, IO Cable): 30x, 250M IR SD9364-EHL(with Bracket, IO Cable): 30x, 150M IR SD9364-EHL(without Bracket, IO Cable): 30x, 150M IR
System Information	
CPU	Multimedia SoC (System-on-Chip)
Flash	128MB
RAM	512MB
Camera Features	
Image Sensor	SD9364-EH: 1/2.8" Progressive CMOS SD9364-EHL: 1/3" Progressive CMOS
Maximum Resolution	1920x1080
Lens Type	30x Optical Zoom, Auto Focus
Focal Length	f = 4.3 ~ 129 mm (30x zoom)
Aperture	F1.6 ~ F4.7
Auto-iris	DC-iris
Field of View	SD9364-EH: 2.3° ~ 64° (Horizontal) 1.3° ~ 36° (Vertical) 2.6° ~ 73° (Diagonal) SD9364-EHL: 2° ~ 59° (Horizontal) 2° ~ 45° (Vertical) 3° ~ 71° (Diagonal)
Shutter Time	SD9364-EH: 1 sec to 1/10,000 sec SD9364-EHL: 1/8 sec to 1/30,000 sec
WDR Technology	WDR Pro
Day/Night	Removable IR-cut filter for day & night function
Minimum Illumination	SD9364-EH: 0.07 Lux @ F1.6 (Color), 0 Lux @ F1.6 (B/W) SD9364-EHL: 0.42 Lux @ F1.6 (Color), 0.001 Lux @ F1.6 (B/W)
Pan Speed	0.1° ~ 300° / sec
Pan Range	360° endless
Tilt Speed	0.1° ~ 300° / sec
Tilt Range	220° (-110° ~ +110°)
Preset Locations	256 preset locations 128 presets per tour
Pan/Tilt/Zoom Functionalities	SD9364-EH: 48x digital zoom (4x on IE plug-in, 12xbuilt-in), Auto pan mode, Auto patrol mode SD9364-EHL: 128x digital zoom (4x on IE plug-in, 32xbuilt-in), Auto pan mode, Auto patrol mode
IR Illuminators	SD9364-EH: 250 m SD9364-EHL: 150 m
On-board Storage	Slot type: SD/SDHC/SDXC card slot Seamless Recording
Video	
Compression	H265, H264, MJPEG
Maximum Frame Rate	H.265 & H.264: 60 fps @ 1920x1080 MJPEG: 30 fps @ 1920x1080
Maximum Streams	4 simultaneous streams
S/N Ratio	SD9364-EH: 62 dB SD9364-EHL: 54 dB
Dynamic Range	SD9364-EH: 120 dB SD9364-EHL: 110 dB
Video Streaming	Adjustable resolution, quality and bitrate Smart Stream II
Image Settings	Adjustable image size, quality and bit rate; Time stamp, text overlay, flip & mirror; Configurable brightness, contrast, saturation, sharpness, white balance, exposure control, gain, backlight compensation, privacy masks (Up to 24); Scheduled profile settings, Defog, 3DNR, EIS, HLC
Audio	
Audio Capability	Two-way audio (full duplex)
Compression	G.711, G.726
Interface	External microphone input External line output
Network	
Users	Live viewing for up to 10 clients

Protocols	IPv4, IPv6, TCP/IP, HTTP, HTTPS, UPnP, RTPSP/ RTP/RTCP, IGMP, SMTP, FTP, DHCP, NTP, DNS, DDNS, PPPoE, CoS, QoS, SNMP, 802.1X, UDP, ICMP, ARP, SSL, TLS, NTCIP
Interface	10 Base-T/100 Base-TX/1000 Base-T Ethernet (RJ-45) *It is highly recommended to use standard CAT5e & CAT6 cables which are compliant with the 3P/ETL standard.
ONVIF	Supported, specification available at www.onvif.org
Intelligent Video	
Video Motion Detection	Five-window video motion detection
Auto-Tracking	Auto-tracking on moving object
Alarm and Event	
Alarm Triggers	Motion detection, manual trigger, digital input, periodical trigger, system boot, recording notification, audio detection
Alarm Events	Event notification using digital output, HTTP, SMTP, FTP, NAS server and SD card File upload via HTTP, SMTP, FTP, NAS server and SD card
General	
Connectors	RJ-45 cable connector for Network 10/100/1000Mbps PoE connection Audio input Audio output DC 48V power input Digital input*4 Digital output*2 RS-485 for PTZ control (PelcoD protocol, Baud rate 2400)
LED Indicator	System power and status indicator
Power Input	95W PoH/PoE DC 48V
Power Consumption	Max. 81.8 W (Heater on) Max. 28.5 W (Heater off)
Dimensions	Ø 204 x 285 mm
Weight	7.43 kg (with bracket) 6.03 kg (without bracket)
Casing	IP66, IK10, NEMA 4X
Safety Certifications	CE, FCC Class A, VCCI, C-tick, NEMA 4X, UL
Operating Temperature	Starting Temperature: -40°C ~ 55°C (-40°F ~ 131°F) Working Temperature: -50°C ~ 55°C (-58°F ~ 131°F)
Humidity	90%
Warranty	36 months
System Requirements	
Operating System	Microsoft Windows 8/7/Vista/XP/2000
Web Browser	Mozilla Firefox 7~43 (streaming only) Internet Explorer 7/8/9/10/11
Other Players	VLC: 1.1.11 or above Quicktime: 7 or above
Included Accessories	
CD	User's manual, quick installation guide, Shepherd, VAST Wall mount bracket*, I/O cable*, screws, waterproof connectors, terminal blocks, quick installation guide, warranty card, alignment sticker, ground wire, T25 star driver, software CD, desiccant bags *: Standard package for SD9364-EH/EHL(with Bracket, IO Cable).
Others	



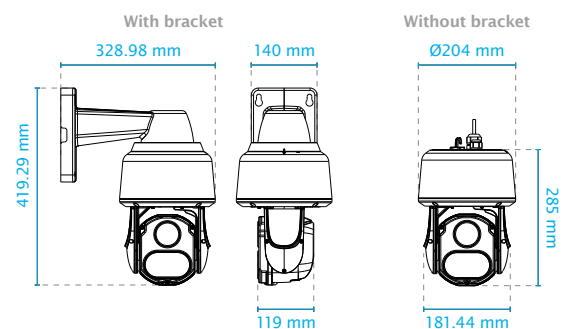









Dimensions



Ordering Information

Model	Description	P/N	
SD9364-EH	SD9364-EH(with Bracket, IO Cable)	H.265 Full HD IR PTZ Camera (30x, 250M IR), with Bracket and IO Cable	100147900G
	SD9364-EH(without Bracket, IO Cable)	H.265 Full HD IR PTZ Camera (30x, 250M IR), without Bracket and IO Cable	100182400G
SD9364-EHL	SD9364-EHL(with Bracket, IO Cable)	H.265 Full HD IR PTZ Camera (30x, 150M IR), with Bracket and IO Cable	100144200G
	SD9364-EHL(without Bracket, IO Cable)	H.265 Full HD IR PTZ Camera (30x, 150M IR), without Bracket and IO Cable	100182300G

Compatible Accessories

Mounting Kits		Others					
							
AM-220 Wall Mount Bracket	AM-529 Mounting Adapter	AJ-001 USB Joystick	AJ-002 USB Joystick	AO-003 I/O Combo Cable			
Cabinet							
							
AT-CAS-001 Cabinet for Speed Dome, IP66, IK10	AT-CAB-002 Cabinet for HLG Power Supply	AT-SUN-002 Sunshield	AT-SWH-000 Power Safety Kit				
PoE Kit/Power Adapter							
48VDC							
	+						
AW-IHS-0200/0201/0203 Industrial Fiber Media Converter		HLG-120H-48 Industrial 48VDC/120W Power Supply, IP67	HLG-120H-48 Industrial 48VDC/120W Power Supply, IP67				
95W PoH/PoE							
	+			+			
AW-IHH-0100 Industrial 1xGE 95W PoH/PoE Injector		HLG-120H-54 Industrial 54VDC/120W Power Supply, IP67	AW-IHH-0200 Industrial 1xGE 95W PoH/PoE + 1x SFP GE Switch		HLG-120H-54 Industrial 54VDC/120W Power Supply, IP67	AP-GIC-011A-095 1xGE 95W PoH/PoE Injector with Surge Protection 12KV	AP-GIC-015B-095 Outdoor 1xGE 95W PoH/PoE Injector with Surge Protection 12KV, IP67, IK10