



# Outdoor VivoCam L2+ Series

Outdoor VivoCam L2+ Managed PoE Switch



Managing IP Surveillance • L2+ Gigabit PoE Switch • Surge Protection • IP67 • IK10

VIVOTEK's outdoor VivoCam L2+ series is the Layer 2 plus managed PoE switch with IP surveillance management functions and it's outdoor ready with waterproof IP67, Vandal proof IK10 and surge protection each port up to 6KV. This switch is not only a standard Layer 2 plus managed PoE switch, but also able to set up and configure VIVOTEK IP cameras, Video servers and allows users to find all VIVOTEK devices and deploy a surveillance network system automatically.

The Outdoor VivoCam L2+ series, also features Graphic View, such as Topology/Map view for controlling and understanding network structure and device situation, and Google Map inte-

gration to view system situation status for outdoor applications. It not only features surveillance network environment set up functions, but troubleshooting and traffic monitoring functions also help users to clarify and troubleshoot any connection or device issue. In addition, users can also import and export their VIVOTEK IP camera/Video servers configuration files, and batch VIVOTEK cameras firmware upgrade through the VivoCam L2+ Managed PoE switch Web UI. With all of these features and more, the outdoor industrial VivoCam L2+ series, is the best outdoor PoE solution to install and manage VIVOTEK outdoor surveillance devices at outdoor environment.

## Plug and Play Installation with All in One Device

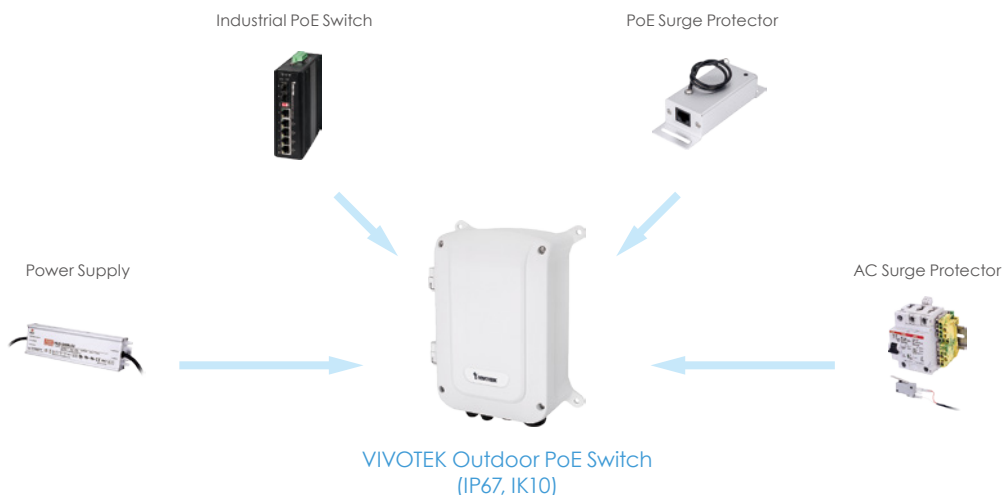

# Features

- Waterproof IP67
- IK10 Impact Rated Cast Aluminum Housing
- Built-in 6KV Surge Protection for Each PoE Port
- Built-in 40KV Surge Protection for AC Power
- Operating Temperature from -40°C ~ 65°C

## Managing IP Surveillance

- Auto Generated Surveillance Topology View
- Easy Tag VLAN Configuration In Topology View
- Smart Device-Management In Topology View
- PoE On/Off Control In Topology View
- Display IP Camera Live Stream in Topology View, Floor View and Google Map View
- Batch Camera/Video Server F/W Upgrade
- Batch Camera Configuration-File Import & Export
- Batch Camera Network/Login Configuration

## Managed Layer 2 Plus PoE Switch

- Supports DHCP Server
- Supports IPv4/IPv6 L3 Static Route
- Supports IEEE802.1Q VLAN(up to 4096), Double Tag (Q-in-Q)
- Supports 802.1d (STP), 802.1w (RSTP) and 802.1s (MSTP)
- Supports LACP and Static Link Aggregation
- Supports SNMP v1/v2c/v3 for Management
- Supports HTTPs/SSL/SSHv1&v2 for Secured Connection
- Supports Dual Image for Switch Firmware Backup

# Feature Highlight - Managing IP Surveillance

Auto-refresh

Show  entries

Remove	Status	Device Type	Model Name	Device Name	MAC	IP Address
<input type="checkbox"/>	Online	IP Camera	FE8174	Mega-Pixel Network Camera	00-02-01-2A-51-2B	192.168.40.80
<input type="checkbox"/>	Online	IP Camera	FD6154V	Mega-Pixel Network Camera	00-02-01-30-D6-4E	192.168.40.83
<input type="checkbox"/>	Online	IP Camera	IP8364	Mega-Pixel Network Camera	00-02-01-22-97-35	192.168.40.85
<input type="checkbox"/>	Online	IP Camera	FD6182-F2	FD6182-F2	00-02-01-38-F3-8D	192.168.40.86
<input type="checkbox"/>	Online	IP Camera	FD6362E	Mega-Pixel Network Camera	00-02-01-21-29-05	192.168.40.88
<input type="checkbox"/>	Online	IP Camera	IB8336-H	IB8336-H	00-02-01-2F-99-81	192.168.40.89
<input type="checkbox"/>	Online	IP Camera	FD6173-H	Mega-Pixel Network Camer	00-02-01-30-5B-9F	192.168.40.94
<input type="checkbox"/>	Online	IP Camera	CC8130	Mega-Pixel Network Camer	00-02-01-1D-21-83	192.168.40.95
<input type="checkbox"/>	Online	IP Camera	IP8335H	Mega-Pixel Network Camera	00-02-01-25-33-E7	192.168.40.96
<input type="checkbox"/>	Online	IP Camera	I29361-EH	I29361-EH	00-02-01-43-E6-52	192.168.40.97

### Auto Discovery

AW-GEV L2+ Series can automatically discover any VIVOTEK's devices such as network cameras, video servers, CMS and NVR with a simple click of mouse.

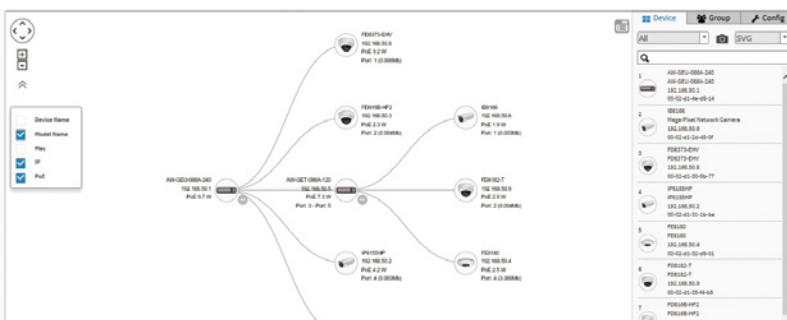

### Graphic View - Topology View

Auto-generated Topology View allows administrators to quickly view and export a complete network topology in SVG/PNG/PDF format for easier inspection and planning.



### Graphic View - Floor View

Upload custom floor images. Floor View allows for quick location of deployed surveillance devices and for export of this view in SVG/PNG/PDF format for easier inspection and planning.

# Feature Highlight - Managing IP Surveillance

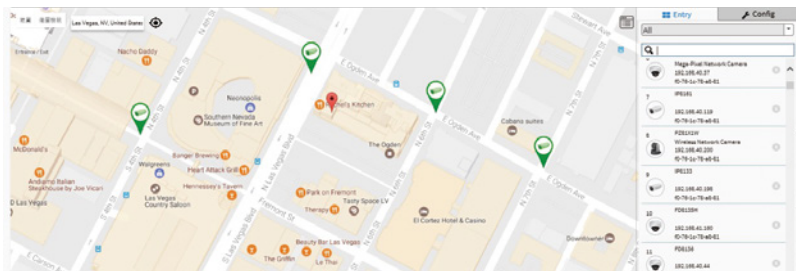

## Graphic View - Google Map

Locate surveillance devices on Google map to simplify multi-site management of any large scale deployments.



## Device Management

Easy network configuration, open camera Web UI, diagnose camera connection and cable status, display camera live stream, change camera network setting, restore default, PoE consumption, and PoE on/off control.



## Device Status

Device Status page to show the real-time verification result of each connection between switch port and device.

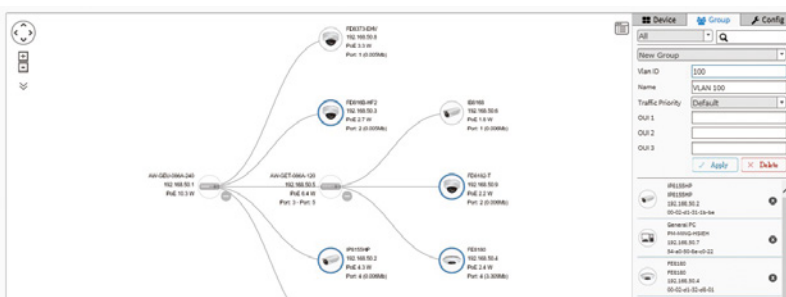

## VLAN Setting

Hierarchical topology view allows administrators to easily build a VLAN.



## Live Stream

Display live streaming camera window in Topology View, Floor View and Google Map View.

# Application

## Long Range Application

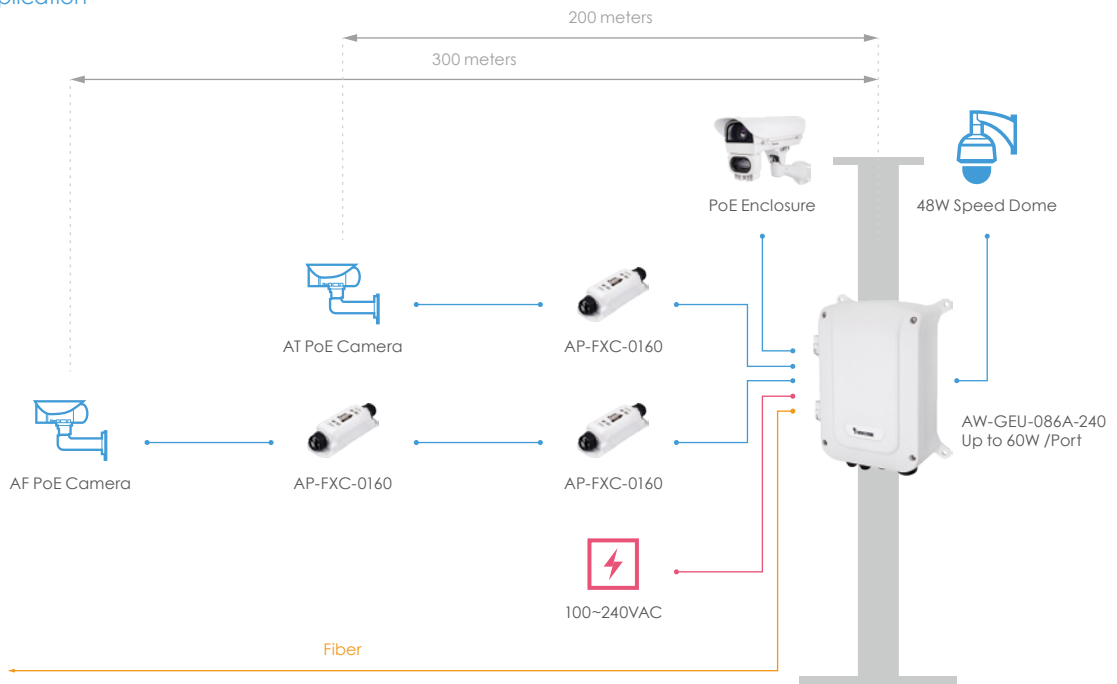

## Multi-Camera Application

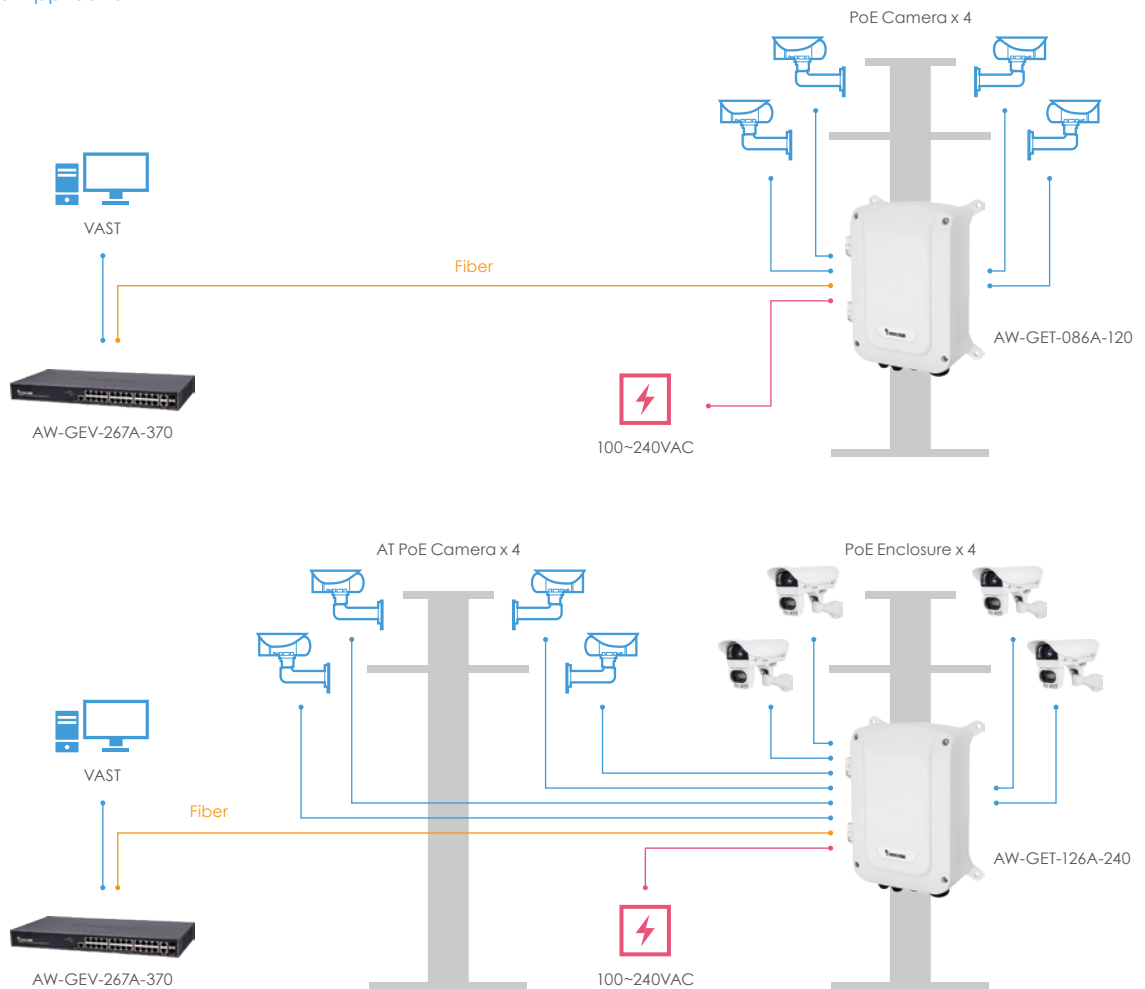

## Ordering Information

Model Name	Product Description	Model Name	Product Description
Outdoor Industrial VivoCam L2+ Series		AW-GET-123A-240	Outdoor Industrial 8xGE PoE + 4xGE SFP Switch, -40°C ~ 65°C
AW-GET-086A-120	Outdoor Industrial 4xGE PoE + 2xGE UTP + 2xGE SFP L2+ managed Switch, 120W, -40°C ~ 65°C	<b>Outdoor PoE Extender</b>	
AW-GEU-086A-240	Outdoor Industrial 4xGE UPoE + 2xGE UTP + 2xGE SFP L2+ managed Switch, 240W, -40°C ~ 65°C	AP-FXC-0160	Outdoor 1-Port FE PoE Extender
AW-GET-126A-240	Outdoor Industrial 8xGE PoE + 2xGE UTP + 2xGE SFP L2+ managed Switch, 240W, -40°C ~ 65°C	AP-FXC-0260	Outdoor 2-Port FE PoE Extender
Outdoor Industrial Unmanaged series		<b>IP Surveillance Device</b>	
AW-GET-083A-120	Outdoor Industrial 4xGE PoE + 2xGE UTP + 2xGE SFP Switch, -40°C ~ 65°C	Network Camera	All VIVOTEK Network Cameras
AW-GEU-083A-240	Outdoor Industrial 4xGE UPoE + 2xGE UTP + 2xGE SFP Switch, -40°C ~ 65°C	Video Server	All VIVOTEK Video Servers
		NVR	All VIVOTEK NVRs
		CMS	VAST, VAST 2

## Technical Specifications

Model	AW-GET-086A-120	AW-GEU-086A-240	AW-GET-126A-240
Product Description	Outdoor VivoCam L2+ Managed PoE Switch 4xGE PoE + 2xGE UTP + 2xGE SFP + 1xRJ45 Console	Outdoor VivoCam L2+ Managed PoE Switch 4xGE UPoE + 2xGE UTP + 2xGE SFP + 1xRJ45 Console	Outdoor VivoCam L2+ Managed PoE Switch 8xGE PoE + 4xGE SFP + 1xRJ45 Console

### Managing IP Surveillance Functions

#### Management

	AW-GET-086A-120	AW-GEU-086A-240	AW-GET-126A-240
Auto Search VIVOTEK Device	up to 1000 pcs	up to 1000 pcs	up to 1000 pcs
Surveillance Device Management List	√	√	√
DHCP Server Function	√	√	√
VIVOTEK Device Account/ Password Setting	√	√	√
VIVOTEK Device Static IP Setting	√	√	√
VIVOTEK Device Grouping Setting for VLAN	√	√	√
VIVOTEK Device Name Edit	√	√	√
VIVOTEK Camera/Video Server Reboot/Restore Default	√	√	√
VIVOTEK Device Re-direct Link	√	√	√
VIVOTEK Device On/Off Line Status	√	√	√
<b>Graphic View</b>			
Topology View	√	√	√
Floor View	√	√	√
Google Map View	√	√	√
<b>Maintenance</b>			

## Technical Specifications

Model	AW-GET-086A-120	AW-GEU-086A-240	AW-GET-126A-240
Product Description	Outdoor VivoCam L2+ Managed PoE Switch 4xGE PoE + 2xGE UTP + 2xGE SFP + 1xRJ45 Console	Outdoor VivoCam L2+ Managed PoE Switch 4xGE UPoE + 2xGE UTP + 2xGE SFP + 1xRJ45 Console	Outdoor VivoCam L2+ Managed PoE Switch 8xGE PoE + 4xGE SFP + 1xRJ45 Console
VIVOTEK Camera/Video Server Batch SW Upgrade	V	V	V
VIVOTEK Camera/Video Server Configuration File Export/Import	V	V	V
VIVOTEK Cameras/Video Server Configuration File Management	V	V	V
Floor Image Management	V	V	V
Export Surveillance Management Device List	V	V	V
Security	V	V	V
Trouble Shooting	V	V	V
Traffic Monitoring	V	V	V
<b>Managed Layer 2+ PoE Switch Functions</b>			
<b>Port Configuration</b>			
10M/100M/1G RJ45 PoE Port	4 /Per Port 30W PoE	4 /Per Port 60W UPoE	8 /Per Port 30W PoE
10M/100M/1G RJ45 Port	2	2	-
1G SFP Slot	2	2	4
RJ45 Console Port	1	1	1
<b>HW Performance</b>			
Switching Bandwidth	16 Gbps	16 Gbps	24Gbps
Forwarding Capacity	11.904 Mpps	11.904 Mpps	17.856 Mpps
MAC Address	8K	8K	8K
Jumbo Frames	9216 Bytes	9216 Bytes	9216 Bytes
<b>Layer 2+ Features</b>			
Spanning Tree	IEEE802.1D (STP)	V	V
	IEEE802.1w (RSTP)	V	V
	IEEE802.1s (MSTP)	V	V
VLAN	802.1Q VLAN	4096 VLAN IDs	4096 VLAN IDs
	SVL/ IVL	V	V
	Private VLAN	V	V
	Guest VLAN	V	V
	Q-in-Q (Double Tag)	V	V
	802.1v Protocol VLAN	V	V
	MAC-based VLAN	V	V
	IP Subnet-based VLAN	V	V
Trunking	IEEE 802.3ad LACP	Up to 4 ports in a group, max. up to 6 groups	up to 4 ports in a group , max. up to 6 groups

## Technical Specifications

Model		AW-GET-086A-120	AW-GEU-086A-240	AW-GET-126A-240
Product Description		Outdoor VivoCam L2+ Managed PoE Switch 4xGE PoE + 2xGE UTP + 2xGE SFP + 1xRJ45 Console	Outdoor VivoCam L2+ Managed PoE Switch 4xGE UPoE + 2xGE UTP + 2xGE SFP + 1xRJ45 Console	Outdoor VivoCam L2+ Managed PoE Switch 8xGE PoE + 4xGE SFP + 1xRJ45 Console
Trunking	Static Trunk	Up to 4 ports in a group, max. up to 6 groups	up to 4 ports in a group , max. up to 6 groups	up to 4 ports in a group , max. up to 6 groups
IGMP Snooping (v1/v2/v3)		V	V	V
Loop Detection		V	V	V
<b>L3 Features</b>				
IP Host Table		V	V	V
IPv4/v6 Static Routing		V	V	V
Static ARP		V	V	V
DHCP Server		V	V	V
<b>QoS Features</b>				
Hardware Queues		8	8	8
Classification	Port Based	V	V	V
	802.1p VLAN priority based	V	V	V
	IPv4/IPv6 precedence / DSCP based	V	V	V
	Differentiated Services (DiffServ)	V	V	V
	Classification and re- marking ACLs	V	V	V
Rate Limiting	Ingress	V	V	V
	Egress	V	V	V
	Per Port	V	V	V
Priority Queue Scheduling	WRR	V	V	V
	Strict Priority	V	V	V
IPv4 QoS (QCEs)		V	V	V
IPv6 QoS (QCEs)		V	V	V
<b>Security</b>				
Port Security (MAC-based)		V	V	V
IEEE802.1x		V	V	V
ACLs	Source and destination MAC, VLAN ID or IP address, protocol, port	V	V	V
	(DSCP) / IP precedence	V	V	V
	TCP/ UDP source and destination ports	V	V	V
	802.1p priority	V	V	V
	ICMP Packets	V	V	V
IP Source Guard (IP-MAC- Port Binding)		V	V	V
Storm Control		V	V	V

## Technical Specifications

Model		AW-GET-086A-120	AW-GEU-086A-240	AW-GET-126A-240
Product Description		Outdoor VivoCam L2+ Managed PoE Switch 4xGE PoE + 2xGE UTP + 2xGE SFP + 1xRJ45 Console	Outdoor VivoCam L2+ Managed PoE Switch 4xGE UPoE + 2xGE UTP + 2xGE SFP + 1xRJ45 Console	Outdoor VivoCam L2+ Managed PoE Switch 8xGE PoE + 4xGE SFP + 1xRJ45 Console
RADIUS Authentication (RFC2138)		✓	✓	✓
DDoS Prevention		✓	✓	✓
Layer 3 Isolation ( Allow/disallow routing between IP Subnets)		✓	✓	✓
HTTPs and SSL (Secured Web)		✓	✓	✓
SSH v1.5/v2.0 (Secured Telnet Session)		✓	✓	✓
BPDU Guard		✓	✓	✓
STP Root Guard		✓	✓	✓
DHCP Snooping		✓	✓	✓
<b>Management</b>				
SNMP (v1, v2c, v3)		✓	✓	✓
RMON ( 1,2,3 & 9 groups)		✓	✓	✓
Software Upgrade		✓	✓	✓
Configuration Export/Import		✓	✓	✓
DHCP	Client	✓	✓	✓
	Option 66	✓	✓	✓
	Option 67	✓	✓	✓
Event/Error Log	Syslog	✓	✓	✓
Management Access Filtering	SNMP	✓	✓	✓
	Web	✓	✓	✓
	Telnet	✓	✓	✓
Port Mirroring		✓	✓	✓
MLD Snooping		✓	✓	✓
LLDP (IEEE802.1AB)		✓	✓	✓
LLDP-MED		✓	✓	✓
CDP		✓	✓	✓
NTP/ SNTP (RFC2030)		✓	✓	✓
<b>IPv6 Support</b>				
Dual IPv6/IPv4 Stack		✓	✓	✓
IPv6 Web/SSL		✓	✓	✓
IPv6 SNTP (Simple Network Time Protocol)		✓	✓	✓
IPv6 Telnet Server/SSH		✓	✓	✓
IPv6 Ping Trace Route		✓	✓	✓



## Technical Specifications

Model	AW-GET-086A-120	AW-GEU-086A-240	AW-GET-126A-240
Product Description	Outdoor VivoCam L2+ Managed PoE Switch 4xGE PoE + 2xGE UTP + 2xGE SFP + 1xRJ45 Console	Outdoor VivoCam L2+ Managed PoE Switch 4xGE UPoE + 2xGE UTP + 2xGE SFP + 1xRJ45 Console	Outdoor VivoCam L2+ Managed PoE Switch 8xGE PoE + 4xGE SFP + 1xRJ45 Console
IPv6 TFTP	V	V	V
IPv6 RADIUS	V	V	V
IPv6 Syslog	V	V	V
IPv6 DNS Client	V	V	V
IPv6 Protocol-based VLANs	V	V	V
IPv6 SNMP	V	V	V
<b>PoE Management</b>			
ON/OFF Config	V	V	V
Alive Checking for PD	V	V	V
Power Delay	V	V	V
7/24 On/Off Scheduling	V	V	V
<b>PoE Function</b>			
Number of PoE Out Ports	4	4	8
Max. PoE Output Power / Per Port	30W	60W	30W
802.3at/af standard Compatible	V	V	V
Over Current Protection	V	V	V
Circuit Shorting Protection	V	V	V
Total PoE Power Budget	120W	240W	240W
Power Pin Assignment	1/2(+), 3/6(-)	1/2(+), 3/6(-), 4/5(+), 7/8(-)	1/2(+), 3/6(-)
PoE PD Auto Detection	V	V	V
<b>Environmental Specifications</b>			
Waterproof IP Rating	IP67	IP67	IP67
Vandal Proof	IK10	IK10	IK10
Operating Temperature	-40°C ~ 65°C (-40°F ~ 149°F)	-40°C ~ 65°C (-40°F ~ 149°F)	-40°C ~ 65°C (-40°F ~ 149°F)
Operating Humidity	10 ~ 90% RH	10 ~ 90% RH	10 ~ 90% RH
Storage Temperature	-40°C ~ 75°C (-40°F ~ 167°F)	-40°C ~ 75°C (-40°F ~ 167°F)	-40°C ~ 75°C (-40°F ~ 167°F)
Storage Humidity	10 ~ 90% RH	10 ~ 90% RH	10 ~ 90% RH
<b>Mechanical Specifications</b>			
Dimensions	315.4(W) x 245.8(H) x 118(D) mm	315.4(W) x 245.8(H) x 118(D) mm	315.4(W) x 245.8(H) x 118(D) mm
Weight	4.52 KG	4.52 KG	4.52 KG
<b>Power Specifications</b>			
Input Voltage	100VAV ~ 240VAC	100VAV ~ 240VAC	100VAV ~ 240VAC

## Technical Specifications

Model	AW-GET-086A-120	AW-GEU-086A-240	AW-GET-126A-240
Product Description	Outdoor VivoCam L2+ Managed PoE Switch 4xGE PoE + 2xGE UTP + 2xGE SFP + 1xRJ45 Console	Outdoor VivoCam L2+ Managed PoE Switch 4xGE UPoE + 2xGE UTP + 2xGE SFP + 1xRJ45 Console	Outdoor VivoCam L2+ Managed PoE Switch 8xGE PoE + 4xGE SFP + 1xRJ45 Console
Output Voltage Range /Per PoE Port	54VDC PoE IEEE 802.3af (Max. 15.4W) output PoE+ IEEE802.3at (Max. 30W) output	54VDC PoE IEEE 802.3af (Max. 15.4W) output PoE+ IEEE802.3at (Max. 30W) output UPoE (Max. 60W) output	54VDC PoE IEEE 802.3af (Max. 15.4W) output PoE+ IEEE802.3at (Max. 30W) output
Surge Protection /each PoE Port	6KV	6KV	6KV
Surge Protection for AC Power	40KV	40KV	40KV

### Certifications

Certifications	CE, FCC, LVD, VCCI, C-Tick	CE, FCC, LVD, VCCI, C-Tick	CE, FCC, LVD, VCCI, C-Tick
----------------	----------------------------	----------------------------	----------------------------

### Optional Accessories

SFP Transceiver	SFP-1000-MM85-X5I: MMF, 0.5 km, -40°C ~ 85°C SFP-1000-MM13-02I: MMF, 2 km, -40°C ~ 85°C SFP-1000-SM13-10I: SMF, 10 km, -40°C ~ 85°C SFP-1000-SM13-40I: SMF, 40 km, -40°C ~ 85°C SFP-1000-CPTX-X1I, -40°C ~ 85°C	SFP-1000-MM85-X5I: MMF, 0.5 km, -40°C ~ 85°C SFP-1000-MM13-02I: MMF, 2 km, -40°C ~ 85°C SFP-1000-SM13-10I: SMF, 10 km, -40°C ~ 85°C SFP-1000-SM13-40I: SMF, 40 km, -40°C ~ 85°C SFP-1000-CPTX-X1I, -40°C ~ 85°C	SFP-1000-MM85-X5I: MMF, 0.5 km, -40°C ~ 85°C SFP-1000-MM13-02I: MMF, 2 km, -40°C ~ 85°C SFP-1000-SM13-10I: SMF, 10 km, -40°C ~ 85°C SFP-1000-SM13-40I: SMF, 40 km, -40°C ~ 85°C SFP-1000-CPTX-X1I, -40°C ~ 85°C
-----------------	--	--	--

### Dimensions

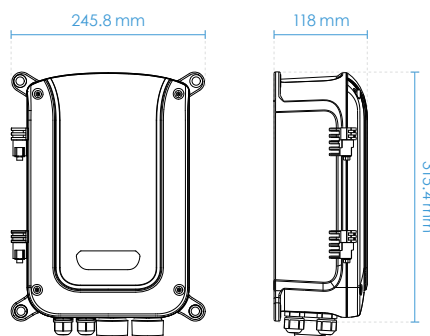

## Compatible Accessories

Pole Mount Bracket		Corner Mount Bracket
		
AM-314	AM-315	AM-414