



Datenblatt - Fiche technique - Data sheet

17.03.0112



ROLINE Modulares Arbeitsplatz-System, CPU-Halter,

ROLINE Modular System CPU Holder,

ROLINE Modular System CPU Holder,

Item no.: 17.03.0112

ROLINE Modular System, CPU Holder, white

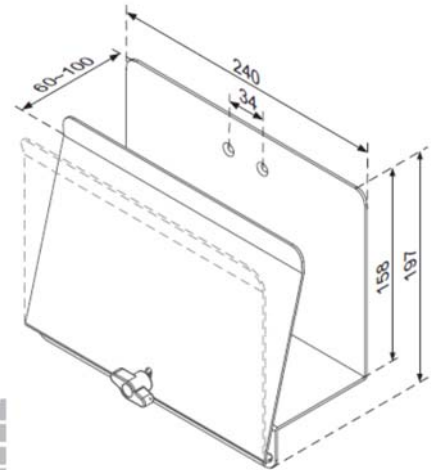
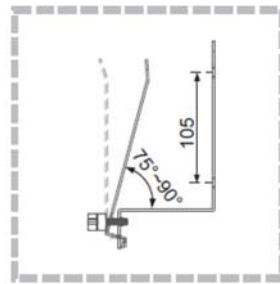

unit:mm

Features:

- Assembly part for display mount which are used for various applications in the Industrial, Office, Education, Hospital, and other fields
- Material: metal
- Colour: white

ROLINE Modular System

These series provides flexible solutions to meet your own various applications

- Warehouse & Inventory control / Assembly Line / Test Lab
- Financial / Trading / Conference Room / Reception
- Library / Cafeteria / Laboratory
- Retail / Wholesale / Public Spaces

- The combination of the different elements of this series allows you the ultimate functionality, flexibility and performance
- **2 ranges can be built: Track Mount Type / Wall Mount Type**
- The spreadsheet below shows you many possible combinations of the elements

- Built for normal duty and heavy duty computer workstation use
- Safe and ergonomic

Track Mount Type

- Slide the monitor arm into place on track easily
- Ideal solution perfect for use in different environments
- Gas-spring assisted arm offers easy height adjustment and ergonomic comfort
- Accommodate users of sitting and standing work postures to create a healthy workplace
- Organized cable management
- The minimum need to realise this is the use of the correspondent elements (ROLINE Modular System Wall Track – 17.03.0102 / ROLINE Modular System TrackMount Bracket – 17.03.0101) in combination with extension arms (with or without gas spring), display bracket, display/keyboard holder...

Wall Mount Type

- Designed for use in space-constrained environment settings
- Superior design to provide easy adjustment
- The arms fold back to the wall into a compact retracted position for space saving
- Multiple configurations maximize productivity and flexibility
- Integrated cable management offers easier cleaning and a neat look
- The minimum need to realise this is the use of the correspondent element (ROLINE Modular System WallMount – 17.03.0100) in combination with extension arms (with or without gas spring), display bracket, display/keyboard holder...

Additional Accessories

- The elements mentioned below can be used as accessories for a better space organization if you are using components like CPU / power adapter (power supply for monitor or CPU) / mouse
- ROLINE Modular System Power Adapter Holder - 17.03.0109
- ROLINE Modular System Mouse Holder - 17.03.0111
- ROLINE Modular System CPU Holder - 17.03.0112



	Order-No. – Packing Unit
ROLINE Modular System WallMount	17.03.0100 – 1
ROLINE Modular System TrackMount Bracket	17.03.0101 – 1
ROLINE Modular System Wall Track	17.03.0102 – 1
ROLINE Modular System Extension Arm, 1 Joint	17.03.0103 – 1
ROLINE Modular System Extension Arm, 2 Joints	17.03.0104 – 1
ROLINE Modular System Highgas Arm, 1 Joint	17.03.0105 – 1
ROLINE Modular System Highgas Arm, 2 Joints	17.03.0106 – 1
ROLINE Modular System Display Bracket	17.03.0110 – 1
ROLINE Modular System Display/Keyboard Holder	17.03.0107 – 1
ROLINE Modular System Keyboard Tray	17.03.0108 – 1
ROLINE Modular System Power Adapter Holder	17.03.0109 – 1
ROLINE Modular System Mouse Holder	17.03.0111 – 1
ROLINE Modular System CPU Holder	17.03.0112 – 1

Possible combination	Wall Mount 17.03.0100	Track Mount 17.03.0101	Wall track 17.03.0102	Ext.Arm 1J 17.03.0103	Ext.Arm 2J 17.03.0104	Highgas 1J 17.03.0105	Highgas 2J 17.03.0106	Display 17.03.0110	Display/Keyboard 17.03.0107	Keyboard Holder 17.03.0108	Power Holder 17.03.0109	Mouse 17.03.0111	CPU Holder 17.03.0112	Max. Load (kg)
1	•							•						15
2	•			•				•						15
3	•			•					•		(x)	(x)	(x)	15
4	•			•						•				6
5	•				•			•						15
6	•				•						(x)	(x)	(x)	15
7	•				•					•				6
8	•					•		•						15
9	•					•			•		(x)	(x)	(x)	9
10	•						•	•						15
11	•						•		•		(x)	(x)	(x)	9
12		•	•					•						15
13		•	•	•				•						15
14		•	•	•					•		(x)	(x)	(x)	15
15		•	•	•						•				6
16		•	•		•			•						15
17		•	•		•				•		(x)	(x)	(x)	15
18		•	•		•					•				6
19		•	•			•		•						15
20		•	•			•			•		(x)	(x)	(x)	9
21		•	•				•	•						15
22		•	•				•		•		(x)	(x)	(x)	9

Combination of: 17.03.0101 + 17.03.0102 + 17.03.0103 + 17.03.0105 + 17.03.0108

Combination of: 17.03.0100 + 17.03.0106 + 17.03.0108

Combination of: 17.03.0100 + 17.03.0105 + 17.03.0110

Combination of: 17.03.0101 + 17.03.0102 + 17.03.0106 + 17.03.0110

Combination of: 17.03.0101 + 17.03.0102 + 17.03.0105 + 17.03.0107 + 17.03.0110

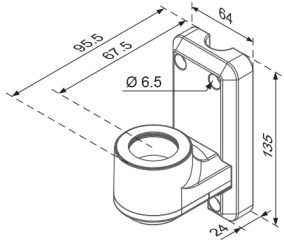

ROLINE Modular System WallMount



17.03.0100

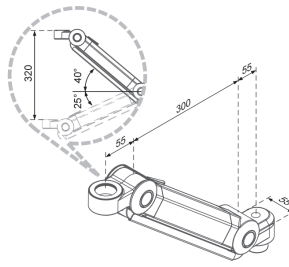

ROLINE Modular System Highgas Arm, 1Joint

17.03.0105

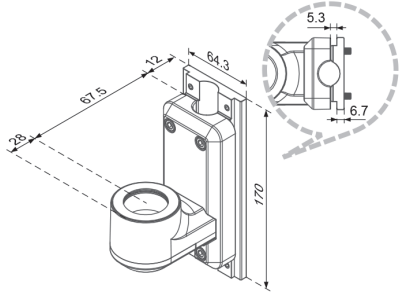

ROLINE Modular System TrackMount Bracket



17.03.0101

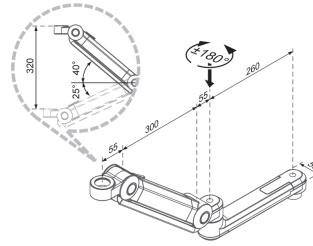

ROLINE Modular System Highgas Arm, 2Joint

17.03.0106

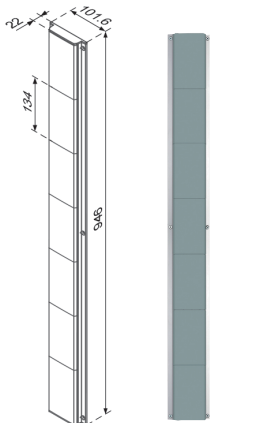

ROLINE Modular System Wall Track

17.03.0102

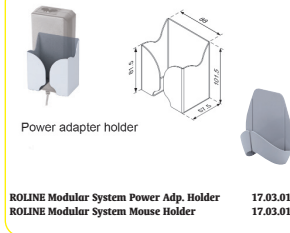

Power adapter holder

ROLINE Modular System Power Adp. Holder

17.03.0109

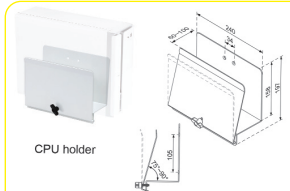

CPU holder

ROLINE Modular System Mouse Holder

17.03.0111

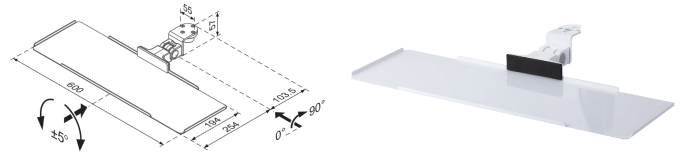

ROLINE Modular System Keyboard Tray

17.03.0108

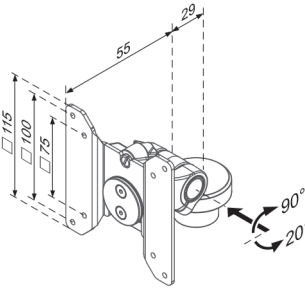

ROLINE Modular System Display Bracket

17.03.0110

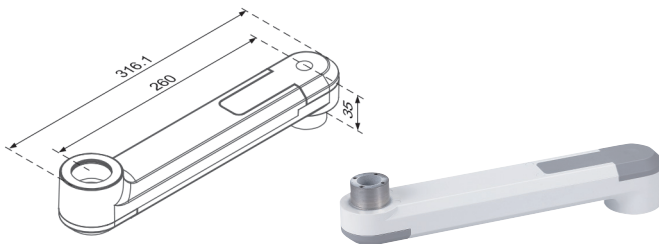

ROLINE Modular System Extension Arm, 1Joint

17.03.0103

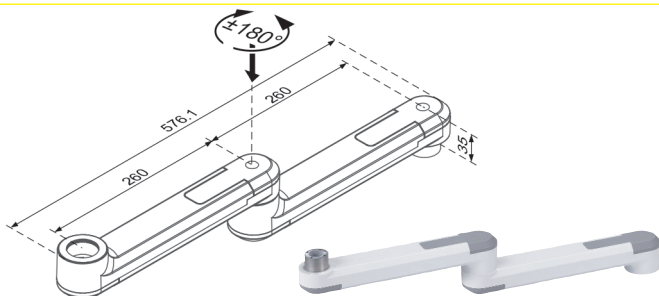

ROLINE Modular System Extension Arm, 2 Joints

17.03.0104

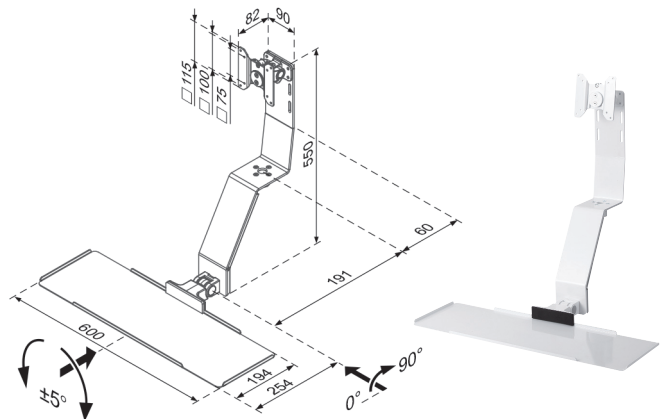

ROLINE Modular System Display/Keyboard

17.03.0107