



Datenblatt - Fiche technique - Data sheet

11.04.5822



ROLINE USB Typ C - VGA Adapterkabel, ST/ST, 3,0 m

ROLINE Câble adaptateur type C - VGA, M/M, 3,0 m

ROLINE USB Type C - VGA Cable, M/M, 3.0 m

Type C Male

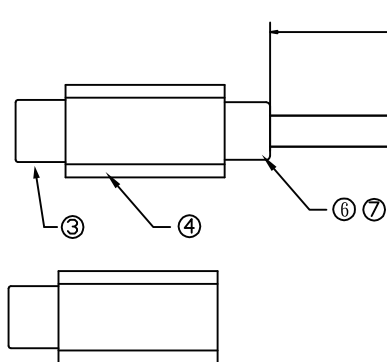
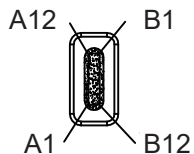

L±30 mm

HDB 15 Male

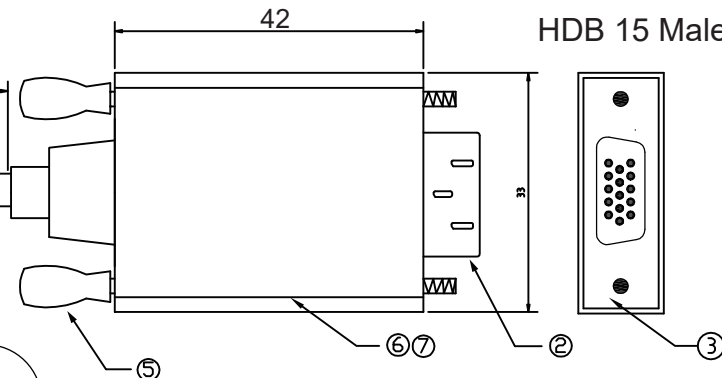

Pin Assignment

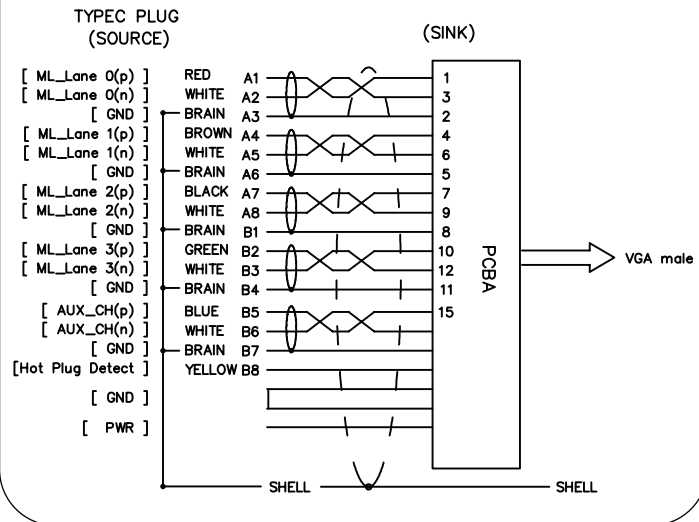

Note: Type C TO VGA Real Machine Detection
Source Resolution:
1920 * 1080P Refresh @Rate: 60HZ

Specification :

- 1 Cable UL20276, [(32AWG*1P+D+AL/MY)*4C+32AWG*5C+24AWG*2C]+AL/MY +BD. Jacket Color: Black, OD: 4.8±0.15mm
- 2 Conn. HDB 15 Male. Shell: Nickel Plated W/PCBA
- 3 Conn. Type C Male. Insulator: Black. Shell: Nickel Plated
- 4 Outer Cover For Type C Male. ABS
- 5 Screw #4-40 UNC Color: Black
- 6 Inside Molding PE
- 7 Outside Molding PVC: 45P. Color: Black

Table :

Part No.	Length	Resistance
11.04.5820	1000mm	2 ohm
11.04.5821	2000mm	2 ohm
11.04.5822	3000mm	2 ohm

Rev.	Date	Contents of Change	Designer	Tol±								Approve	Check	Draw	Design	Product Name	Product No.
				Range	Pla	Met	Ins	Por	Cab	Pac	Gas						
①				0~6	0.1	0.1	0.1	0.2	0.5	1	0.5	0.2	Allen	Allen	Philip	ROLINE Adapter Cable USB Type C-VGA, M/M, Black	11.04.5820/11.04.5821/11.04.5822
②				6~30	0.1	0.1	.15	.25	1	1	0.5	.25					
③				30~80	0.1	.15	0.2	0.3	2	1.5	1	0.3					
④				80~180	.15	.15	.25	0.3	2	2	1	.45					
⑤				180~315	.15	0.2	0.3	0.4	2.5	2	1	0.6					
				315~800	0.2	0.3	0.4	0.5	3	3	2	1.1	Scale	1 : 1	Unit	mm	

